



POELSAN®



POELSAN®

ÜRÜN KATALOĞU
PRODUCTION CATALOGUE

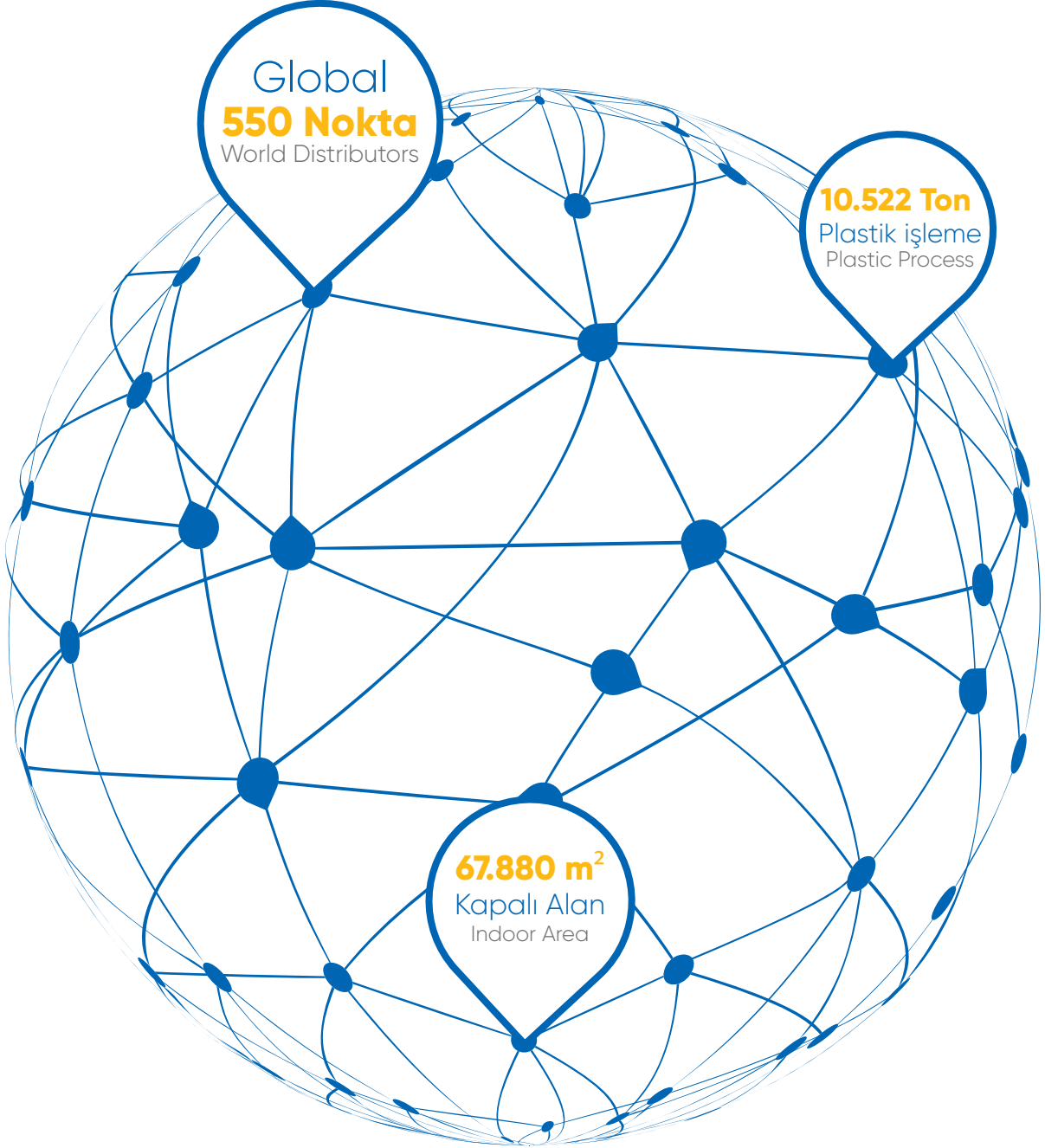

Poelsan Dünya Firmalarıyla Rekabet Ediyor...

+ Poelsan, 1994 yılında henüz ülkemizde üretimi yapılmadığı için ithal edilen Polietilen Kangal Boru Bağlantı Adaptörlerini, kendi tesisinde üreterek piyasaya sunan ilk firma olmuştur.

Poelsan ürünleri, başta peyzaj sektörü olmak üzere, içme suyu şebekelerinde, tarım alanlarında, seralarda, damla sulama sistemlerinde güvenle kullanılabilir. Poelsan ürünleri, başta peyzaj sektörü olmak üzere, içme suyu şebekelerinde, tarım alanlarında, seralarda, damla sulama sistemlerinde güvenle kullanılabilir.

Poelsan, 67.880 m² alanda yıllık 10.522 ton plastik işleme kapasitesiyle üretim yapmaktadır. Poelsan, yurt içinde tüm illere yayılmış yaklaşık 400 bayi ile çalışmakta ve 75 ülkeye ihracat yapmaktadır.

Poelsan, 2.000'in üzerinde ürün çeşidine sahiptir ve sektördeki yeniliklere bağlı olarak mevcut ürün çeşidini sürekli olarak arttırmayı ve sektöründe bir dünya markası olmayı hedeflemektedir.

Poelsan is in the Global Market...

+ Poelsan is the first company that produced and marketed the Compression Fittings for PE Roll Pipes at its own plant, as the mentioned products could not be produced in the country and consequently been imported up to the year 1994.

POELSAN products can be used safely in the areas of landscaping, potable water networks, agricultural irrigation, drip irrigation and greenhouses.

Poelsan produces in 67.880 m² area with its annual plastic process of 10.522 tones. Poelsan cooperates with 400 domestic distributors overall provinces in Turkey and also exports to 75 countries.

Poelsan has a wide product range consisting of more than 2.000 items and aims to extend its current product range consistently depending on the developments in the sector and to be a global brand.



Misyonumuz

- + Teknolojiyi kullanarak yüksek kaliteli ve inovatif ürünler sunmak; bu ürünleri global pazar müşterileri ile buluşturmak.

Vizyonumuz

- + Su sistemlerinde Dünya'da tanınan bir marka ve Türkiye sanayisinin öncü şirketlerinden birisi olmak.

Değerlerimiz

- + İnsan ve Çevreye Saygı
- + Liderlik
- + Güvenilirlik
- + Değerli Hissettirmek
- + Gelişime ve Yeniliğe Açık
- + Takım Ruhu

Our Mission

- + To offer high quality and innovative products using technology; to bring these products together with the global market customers.

Our Vision

- + To become a well known world brand in the World in water systems and one of the leading companies in the Turkish industry.

Our Values

- + Respect for Human and Environment
- + Leadership
- + Reliability
- + Making Feel Valuable
- + Open to Development and Innovation
- + Team Spirit



SEKTÖRÜNDE DÜNYA MARKASI

WORLD'S LEADING BRAND IN THE INDUSTRY



75 2.000 Üzerinde **Ürün Çeşidi**
ÜLKEYE İHRACAT

More than 2.000 products range
exported to 75 countries

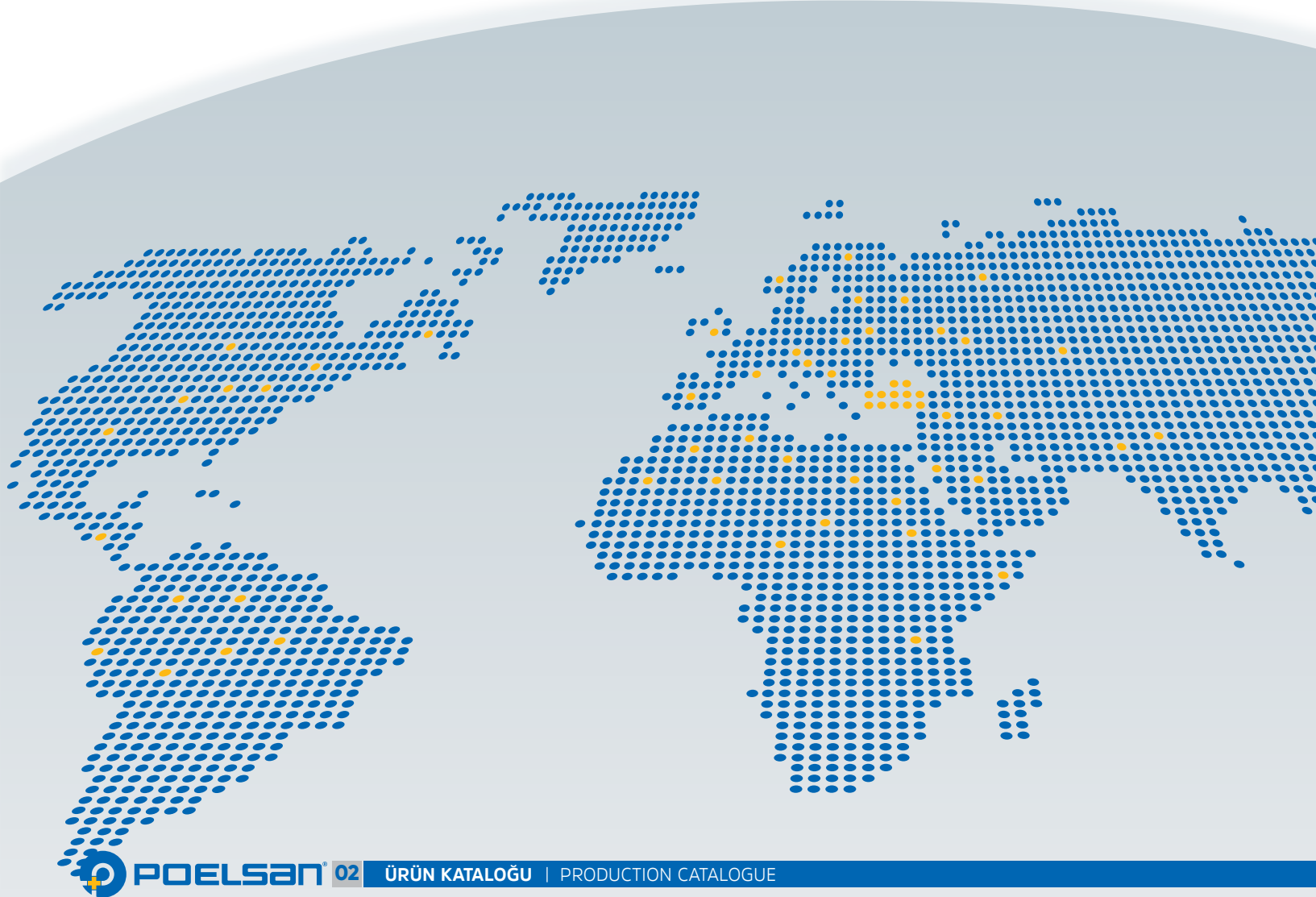

A.B.D. + ALMANYA + ARJANTİN + ARNAVUTLUK + AVUSTRALYA + AZERBAJCAN + BELARUS
BREZİLYA + BİRLEŞİK ARAP EMİRLİKLERİ + BOLİVYA + BOSNA HERSEK + BULGARİSTAN
CEZAYİR + ÇEK CUMHURİYETİ + EKVADOR + ENDONEZYA + ERMENİSTAN + ETİYOPYA
FAS + FRANSA + GÜRCİSTAN + HİNDİSTAN + HOLLANDA + IRAK + İNGİLTERE + İRAN
İRLANDA + İSPANYA + İSRAİL + İTALYA + KAMBOÇYA + KARADAĞ + KATAR + KAZAKİSTAN
KIRGIZİSTAN + KOSOVA + KOSTA RİKA + K.K.T.C. + KUVEYT + LİBYA + LİTVANYA + LÜBNAN
MAKEDONYA + MACARİSTAN + MISIR + MOLDOVA + NORVEÇ + ÖZBEKİSTAN + PAKİSTAN + PERU
POLONYA + PORTEKİZ + ROMANYA + RUSYA + SİRBİSTAN + SLOVAKYA + SURİYE
SUUDİ ARABİSTAN + ŞİLİ + TAYLAND + TUNUS + TÜRKMENİSTAN + UKRAYNA + UMMAN
URUGUAY + ÜRDÜN + YEMEN + VENEZUELA + YENİ ZELANDA + YUNANİSTAN
UNITED STATES OF AMERICA + GERMANY + ARGENTINA + ALBANIA + AUSTRALIA
AZERBAIJAN + BELARUS + BRASIL + UNITED ARAB EMIRATES + BOLIVIA
BOSNIA AND HERZEGOVINA + BULGARIA + ALGERIA + CZECH REPUBLIC + ECUADOR
INDONESIA + ARMENIA + ETHIOPIA + MOROCCO + FRANCE + GEORGIA + INDIA
NETHERLANDS + IRAQ + UNITED KINGDOM + IRAN + IRELAND + SPAIN + ISRAEL + ITALY
CAMBODIA + MONTENEGRO + QATAR + KAZAKHSTAN + KYRGYZSTAN + KOSOVO
COSTA RICA + T.R.N.C + KUWAIT + LIBYA + LITHUANIA + LEBANON
HUNGARY + MACEDONIA + EGYPT + MOLDOVA + NORWAY
UZBEKISTAN + PAKISTAN + PERU + POLAND
PORTUGAL + ROMANIA + RUSSIA + SERBIA
SLOVAKIA + SYRIA + SAUDI ARABIA
CHILE + THAILAND + TUNISIA
TURKMENISTAN + UKRAINE
OMAN + URUGUAY + JORDAN
VENEZUELA + YEMEN
NEW ZEALAND
GREECE

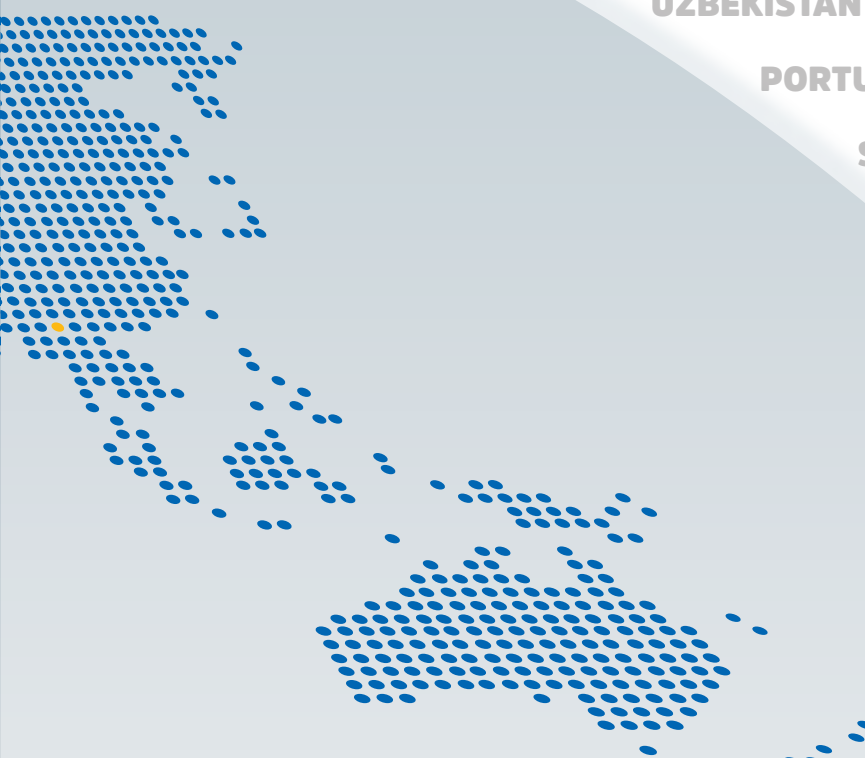

İÇİNDEKİLER / INDEX

08



MAVİ SERİ
BLUE SERIES
СИНЯЯ СЕРИЯ
سلسلة الزرقاء

TSE
TS ISO 17885

22



YEŞİL SERİ
GREEN SERIES
ЗЕЛЕНАЯ СЕРИЯ
سلسلة الخضراء

TSE
TS ISO 17885

39



PRİZ KOLYE
CLAMP SADDLES
СЕДЛОВЫЕ ВРЕЗКИ
ربط السرجي

TSE
TS ISO 13460-1

53



PRİZ KOLYE GEÇMELİ
CLAMP SADDLES WITH SLIDE
СЕДЛОВЫЕ ВРЕЗКИ С ЗАЖИМОМ
ربط السرجي مع دبوس

TSE
TS ISO 13460

56



YEŞİL SERİ KÜRESEL VANA
GREEN SERIES BALL VALVES
КРАНЫ ШАРОВЫЕ ЗЕЛЕНАЯ СЕРИЯ
اقفالة الخضراء

TSE
TS ISO 9911

59



MAVİ SERİ KÜRESEL VANA
BLUE SERIES BALL VALVES
КРАНЫ ШАРОВЫЕ СИНЯЯ СЕРИЯ
اقفالة الزرقاء

TSE
TS ISO 9911

İÇİNDEKİLER / INDEX



TS 13716

VANA KUTULARI

VALVE BOXES

КЛАПАННАЯ КОРОБКА

صناديق



62

LAYFLAT EK PARÇALARI & ÇIKIŞ NİPELLERİ

LAYFLAT FITTINGS & OFFTAKE NIPPLES

ФИТИНГИ ЛАЙФЛЕТ И ВЫХОДНЫЕ НИППЕЛИ

مواد ربط خرطوم الري و زبانة



65

DİŞLİ BAĞLANTI ELEMANLARI

THREADED FITTINGS

РЕЗЬБОВЫЕ ФИТИНГИ

مواد مسننة



72



TS EN ISO 9261

KİLİTLİ BAĞLANTI ELEMANLARI

LOCK TYPE FITTINGS

ЗАЖИМНЫЕ ФИТИНГИ

مواد ربط المغلقة



79



TS EN ISO 9261

MİNİ VANALAR (DN 8)

MINI VALVES (DN 8)

МИНИ КРАНЫ (DN 8)

اقفالة الصغيرة



87



TS EN ISO 9261

MİNİ VANALAR (DN 15)

MINI VALVES (DN 15)

МИНИ КРАНЫ (DN 15)

اقفالة الصغيرة



99

İÇİNDEKİLER / INDEX



DAMLA SULAMA KURTAĞZI EK PARÇALARI

DRIPLINE BARBED FITTINGS

ФИТИНГИ РЕБРИСТЫЕ ДЛЯ
КАПЕЛЬНОГО ОРОШЕНИЯ

مواد القطارة شائكة



TS EN ISO 9261

107



DAMLA SULAMA EK PARÇALARI

DRIPLINE FITTINGS

ФИТИНГИ ДЛЯ КАПЕЛЬНОЙ ТРУБКИ

مواد القطارة



TS EN ISO 9261

115



YASSI DAMLA SULAMA EK PARÇALARI

DRIP TAPE FITTINGS

ФИТИНГИ ДЛЯ КАПЕЛЬНОЙ ЛЕНТЫ

مواد القطارة شريطية



TS EN ISO 9261

123



YÜZÜKLÜ YASSI DAMLA SULAMA EK PARÇALARI

DRIP TAPE FITTINGS WITH RING

ФИТИНГИ ДЛЯ КАПЕЛЬНОЙ
ЛЕНТЫ С КОЛЬЦОМ

مواد القطارة شريطية مع الحلقة



TS EN ISO 9261

131



MİNİSPRINKLER & MİKROFİTİNGLER

MINISPRINKLERS & MICROFITTINGS

МІНІСПРІНКЛЕРІ І МІКРОФІТІНГІ

مرشات الصغيرة و مواد الصغرى

138



HAT ÜSTÜ DAMLATICILAR

ON - LINE DRIPPERS

КАПЕЛЬНИЦА С РЕГУЛИРОВКОЙ РАСХОДА

قطارة

144

İÇİNDEKİLER / INDEX

ÖZEL ÜRETİMLERİMİZ

SPECIAL PRODUCTIONS

СПЕЦИАЛЬНОЕ ПРОИЗВОДСТВО

منتجات خاصة

RURAL EK PARÇALAR

RURAL FITTINGS

ФИТИНГИ ПОЛЕВЫЕ

مواد فلاحية



148

RURAL KÜRESEL VANA

RURAL BALL VALVES

КРАНЫ ПОЛЕВЫЕ

الاقفالة فلاحية



153

SERTİFİKALARIMIZ

CERTIFICATES

СЕРТИФИКАТЫ

الشهادات



156

AMBALAJ BİLGİLERİMİZ

PACKAGE INFORMATION

ИНФОРМАЦИЯ О ПАКЕТЕ

حزمة المعلومات



158

MAVİ SERİ

BLUE SERIES

СИНЯЯ СЕРИЯ

سلسلة الزرقاء

Özellikler

- + Darbelere karşı dayanıklı, yüksek kaliteli polipropilen hammaddeden üretilmiştir.
- + Borulardaki ölçü farklılıklarından veya ovalikten oluşabilecek sorunları konik sıkma özelliği sayesinde önler.
- + UV ışınlarını geçirmediği için yosunlanmaya ve bakteri üremesine izin vermez.
- + Oringi kauçuktan üretilmekte olup yüksek basınç altında sızdırmazlık sağlar.
- + İç yüzeyleri homojen ve gözeneksizdir.
- + Suyun kokusunu ve tadını değiştirebilecek zararlı bileşikler içermez.
- + Dişi ürünlerimiz, korozyona dayanıklı metal yüzük sayesinde değişken sıcaklıklarda yüksek sızdırmazlık sağlar.
- + Diş ölçüleri ISO 7-1 Standardına uygundur.
- + ISO 17885 Standardına uygundur.

Specifications

- + It has been produced from high quality polypropylene raw material and it has resistance to impact.
- + Thanks to the conical tightening feature, it prevents the problems that may occur because of the size differences or ovality in pipes.
- + They prevent alga and bacteria forming due to UV proof (ultraviolet beam) structure.
- + O-rings are made of rubber and provide leakproofness under high pressure.
- + It has a homogeneous and non-porous inner surface.
- + It does not contain any harmful compounds which can change the taste or the smell of the water.
- + Female threaded products provide high leakproofness in changeable temperature values thanks to corrosion resistant reinforcing ring.
- + Thread sizes are compatible with ISO 7-1 Standard.
- + It is compatible with ISO 17885 Standard.



TS ISO 17885



GARANTİ VERİLEN BASINÇ DEĞERİ
GUARANTEED PRESSURE VALUE
Ø 20 mm – Ø 110 mm: PN 16

KULLANIM ALANLARI

- + Şehir Şebekesi İçme Suyu
- + Peyzaj Sektörü
- + Tarımsal Sulama
- + Seralar

INSTALLATION AREAS

- + Urban Potable Water Networks
- + Landscaping Systems
- + Agricultural Irrigation
- + Greenhouses

KOD CODE	EBAT/SIZE d x G	AMBALAJ ADEDİ PACKING QUANTITY	KOLİ ADEDİ BOX QUANTITY	ÇUVAL ADEDİ SACK QUANTITY
10008111	20 x 1/2"	50	700	750
10008112	20 x 3/4"	50	550	650
10008121	25 x 1/2"	25	450	500
10008122	25 x 3/4"	25	450	450
10008123	25 x 1"	25	350	400
10008132	32 x 3/4"	25	275	300
10008133	32 x 1"	25	250	275
10008134	32 x 1 1/4"	25	225	250
10008143	40 x 1"	15	150	180
10008144	40 x 1 1/4"	15	150	165
10008145	40 x 1 1/2"	15	135	150
10008154	50 x 1 1/4"	10	90	100
10008155	50 x 1 1/2"	10	90	100
10008156	50 x 2"	10	80	90
10008165	63 x 1 1/2"	6	54	60
10008166	63 x 2"	6	48	60
10008167	63 x 2 1/2"	6	48	48
10008176	75 x 2"	4	32	36
10008177	75 x 2 1/2"	4	32	32
10008178	75 x 3"	4	28	32
10008186	90 x 2"	4	16	20
10008187	90 x 2 1/2"	4	16	20
10008188	90 x 3"	4	16	20
10008189	90 x 4"	4	12	16
10008195	110 x 2"	2	12	16
10008196	110 x 2 1/2"	2	12	14
10008197	110 x 3"	2	12	14
10008198	110 x 4"	2	12	14

KOD CODE	EBAT/SIZE d x G x d	AMBALAJ ADEDİ PACKING QUANTITY	KOLİ ADEDİ BOX QUANTITY	ÇUVAL ADEDİ SACK QUANTITY
10008311	20 x 1/2" x 20	15	270	300
10008312	20 x 3/4" x 20	15	240	270
10008321	25 x 1/2" x 25	10	200	220
10008322	25 x 3/4" x 25	10	180	200
10008323	25 x 1" x 25	10	160	170
10008331	32 x 1/2" x 32	10	120	140
10008332	32 x 3/4" x 32	10	110	130
10008333	32 x 1" x 32	10	100	120
10008334	32 x 1 1/4" x 32	10	100	110
10008342	40 x 3/4" x 40	5	60	75
10008343	40 x 1" x 40	5	60	70
10008344	40 x 1 1/4" x 40	5	55	70
10008345	40 x 1 1/2" x 40	5	50	70
10008352	50 x 3/4" x 50	4	40	48
10008353	50 x 1" x 50	4	40	48
10008354	50 x 1 1/4" x 50	4	40	44
10008355	50 x 1 1/2" x 50	4	40	44
10008356	50 x 2" x 50	4	32	36
10008363	63 x 1" x 63	3	21	27
10008364	63 x 1 1/4" x 63	3	21	27
10008365	63 x 1 1/2" x 63	3	21	24
10008366	63 x 2" x 63	3	21	24
10008367	63 x 2 1/2" x 63	3	18	21
10008376	75 x 2" x 75	1	14	16
10008377	75 x 2 1/2" x 75	1	12	14
10008378	75 x 3" x 75	1	12	13
10008387	90 x 2 1/2" x 90	1	8	9
10008388	90 x 3" x 90	1	6	9
10008389	90 x 4" x 90	1	7	7
10008396	110 x 2 1/2" x 110	1	6	7
10008397	110 x 3" x 110	1	5	5
10008398	110 x 4" x 110	1	4	5



KABLİN DİŞİ

FEMALE ADAPTOR

МУФТА С ВНУТРЕННЕЙ РЕЗЬБОЙ

بداية سن داخل

GALVANİZ METAL YÜZÜKLÜ

GALVANIZED REINFORCING RING

ОЦИНКОВАННОЕ АРМИРУЮЩЕЕ КОЛЬЦО

بداية سن داخل مع حلقة مدعمة كلفنايز

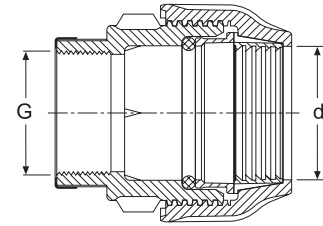

KABLİN DİŞİ TE

FEMALE TEE

ЖЕНСКИЙ ТРОЙНИК

أنثى المحملة

GALVANİZ METAL YÜZÜKLÜ

GALVANIZED REINFORCING RING

ОЦИНКОВАННОЕ АРМИРУЮЩЕЕ КОЛЬЦО

تقسيم سن داخل مع حلقة مدعمة كلفنايز

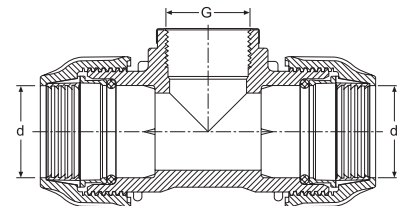



KABLİN DİŞİ DİRSEK

FEMALE ELBOW
ЖЕНСКИЙ ЛОКОТЬ
عكس سن داخل

GALVANİZ METAL YÜZÜKLÜ
GALVANIZED REINFORCING RING
ОЦИНКОВАННОЕ АРМИРУЮЩЕЕ КОЛЬЦО
عكس سن داخل مع حلقة مدعمة كلفنايز

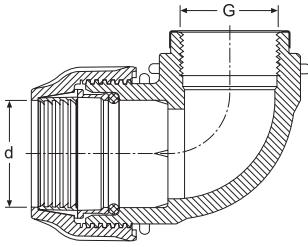

KOD CODE	EBAT/SIZE d x G	AMBALAJ ADEDİ PACKING QUANTITY	KOLİ ADEDİ BOX QUANTITY	ÇUVAL ADEDİ SACK QUANTITY
10008511	20 x 1/2"	25	550	600
10008512	20 x 3/4"	25	450	500
10008521	25 x 1/2"	15	360	390
10008522	25 x 3/4"	15	330	360
10008523	25 x 1"	15	270	300
10008532	32 x 3/4"	10	220	250
10008533	32 x 1"	10	180	220
10008534	32 x 1 1/4"	10	150	170
10008543	40 x 1"	5	120	130
10008544	40 x 1 1/4"	5	100	120
10008545	40 x 1 1/2"	5	90	100
10008554	50 x 1 1/4"	4	72	80
10008555	50 x 1 1/2"	4	60	68
10008556	50 x 2"	4	52	64
10008565	63 x 1 1/2"	4	40	52
10008566	63 x 2"	4	40	48
10008567	63 x 2 1/2"	4	32	40
10008576	75 x 2"	2	24	28
10008577	75 x 2 1/2"	2	20	28
10008578	75 x 3"	2	18	24
10008587	90 x 2 1/2"	1	14	18
10008588	90 x 3"	1	13	15
10008589	90 x 4"	1	10	14
10008597	110 x 3"	1	8	11
10008598	110 x 4"	1	8	10

KOD CODE	EBAT/SIZE d x G	AMBALAJ ADEDİ PACKING QUANTITY	KOLİ ADEDİ BOX QUANTITY	ÇUVAL ADEDİ SACK QUANTITY
10007111	20 x 1/2"	50	700	750
10007112	20 x 3/4"	50	550	650
10007121	25 x 1/2"	25	450	500
10007122	25 x 3/4"	25	450	500
10007123	25 x 1"	25	350	400
10007132	32 x 3/4"	25	275	300
10007133	32 x 1"	25	250	275
10007134	32 x 1 1/4"	25	225	250
10007143	40 x 1"	15	150	180
10007144	40 x 1 1/4"	15	150	165
10007145	40 x 1 1/2"	15	135	150
10007154	50 x 1 1/4"	10	90	100
10007155	50 x 1 1/2"	10	90	100
10007156	50 x 2"	10	80	90
10007165	63 x 1 1/2"	6	54	60
10007166	63 x 2"	6	48	60
10007167	63 x 2 1/2"	6	48	48
10007176	75 x 2"	4	32	36
10007177	75 x 2 1/2"	4	32	32
10007178	75 x 3"	4	28	32
10007186	90 x 2"	4	16	20
10007187	90 x 2 1/2"	4	16	20
10007188	90 x 3"	4	16	20
10007189	90 x 4"	4	12	16
10007195	110 x 2"	2	12	16
10007196	110 x 2 1/2"	2	12	14
10007197	110 x 3"	2	12	14
10007198	110 x 4"	2	12	14

KOD CODE	EBAT/SIZE d x G x d	AMBALAJ ADEDİ PACKING QUANTITY	KOLİ ADEDİ BOX QUANTITY	ÇUVAL ADEDİ SACK QUANTITY
10007311	20 x 1/2" x 20	15	270	300
10007312	20 x 3/4" x 20	15	240	270
10007321	25 x 1/2" x 25	10	200	220
10007322	25 x 3/4" x 25	10	180	200
10007323	25 x 1" x 25	10	160	170
10007331	32 x 1/2" x 32	10	120	140
10007332	32 x 3/4" x 32	10	110	130
10007333	32 x 1" x 32	10	100	120
10007334	32 x 1 1/4" x 32	10	100	110
10007342	40 x 3/4" x 40	5	60	75
10007343	40 x 1" x 40	5	60	75
10007344	40 x 1 1/4" x 40	5	55	70
10007345	40 x 1 1/2" x 40	5	50	70
10007352	50 x 3/4" x 50	4	40	48
10007353	50 x 1" x 50	4	40	48
10007354	50 x 1 1/4" x 50	4	40	44
10007355	50 x 1 1/2" x 50	4	40	44
10007356	50 x 2" x 50	4	32	36
10007363	63 x 1" x 63	3	21	27
10007364	63 x 1 1/4" x 63	3	21	27
10007365	63 x 1 1/2" x 63	3	21	24
10007366	63 x 2" x 63	3	21	24
10007367	63 x 2 1/2" x 63	3	18	21
10007376	75 x 2" x 75	1	14	16
10007377	75 x 2 1/2" x 75	1	12	14
10007378	75 x 3" x 75	1	12	13
10007387	90 x 2 1/2" x 90	1	8	9
10007388	90 x 3" x 90	1	6	9
10007389	90 x 4" x 90	1	7	7
10007396	110 x 2 1/2" x 110	1	6	7
10007397	110 x 3" x 110	1	5	5
10007398	110 x 4" x 110	1	4	5



KABLİN DİŞİ

FEMALE ADAPTOR
внутренней резьбой
بداية سن داخل

PASLANMAZ METAL YÜZÜKLÜ (AISI430)

STAINLESS STEEL REINFORCING RING
КОЛЬЦО ПОДКРЕПЛЕНИЯ НЕРЖАВЕЮЩЕЙ СТАЛИ
بداية سن داخل مع حلقة مدعمة فولاذ

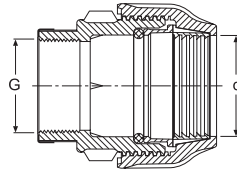

KABLİN DİŞİ TE

FEMALE TEE
Тройник с внутренней резьбой
أنثى المحملة

PASLANMAZ METAL YÜZÜKLÜ (AISI430)

STAINLESS STEEL REINFORCING RING
КОЛЬЦО ПОДКРЕПЛЕНИЯ НЕРЖАВЕЮЩЕЙ СТАЛИ
تقسيم سن داخل مع حلقة مدعمة فولاذ

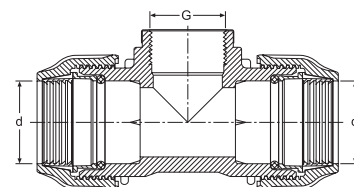



KABLİN DIŞI DİRSEK

FEMALE ELBOW

Отвод с внутренней резьбой

عكس سن داخل

PASLANMAZ METAL YÜZÜKLÜ (AISI430)

STAINLESS STEEL REINFORCING RING

КОЛЬЦО ПОДКРЕПЛЕНИЯ НЕРЖАВЕЮЩЕЙ СТАЛИ

عكس سن داخل مع حلقة مدعمة فولاذ

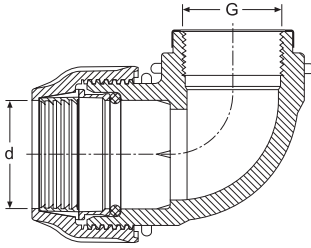

KOD CODE	EBAT/SIZE d x G	AMBALAJ ADEDİ PACKING QUANTITY	KOLİ ADEDİ BOX QUANTITY	ÇUVAL ADEDİ SACK QUANTITY
10007511	20 x 1/2"	25	550	600
10007512	20 x 3/4"	25	450	500
10007521	25 x 1/2"	15	360	390
10007522	25 x 3/4"	15	330	360
10007523	25 x 1"	15	270	300
10007532	32 x 3/4"	10	220	250
10007533	32 x 1"	10	180	220
10007534	32 x 1 1/4"	10	150	170
10007543	40 x 1"	5	120	130
10007544	40 x 1 1/4"	5	100	120
10007545	40 x 1 1/2"	5	90	100
10007554	50 x 1 1/4"	4	72	80
10007555	50 x 1 1/2"	4	60	68
10007556	50 x 2"	4	52	64
10007565	63 x 1 1/2"	4	40	52
10007566	63 x 2"	4	40	48
10007567	63 x 2 1/2"	4	32	40
10007576	75 x 2"	2	24	28
10007577	75 x 2 1/2"	2	20	28
10007578	75 x 3"	2	18	24
10007587	90 x 2 1/2"	1	14	18
10007588	90 x 3"	1	13	15
10007589	90 x 4"	1	10	14
10007597	110 x 3"	1	8	11
10007598	110 x 4"	1	8	10

MAVİ SERİ / BLUE SERIES COMPRESSION FITTINGS

KOD CODE	EBAT / SIZE d x G	AMBALAJ ADEDİ PACKING QUANTITY	KOLİ ADEDİ BOX QUANTITY	ÇUVAL ADEDİ SACK QUANTITY
10001011	20 x 1/2"	50	800	850
10001012	20 x 3/4"	50	700	800
10001021	25 x 1/2"	25	550	550
10001022	25 x 3/4"	25	500	500
10001023	25 x 1"	25	450	500
10001031	32 x 1/2"	25	300	350
10001032	32 x 3/4"	25	300	325
10001033	32 x 1"	25	275	325
10001034	32 x 1 1/4"	25	250	300
10001043	40 x 1"	15	150	180
10001044	40 x 1 1/4"	15	150	180
10001045	40 x 1 1/2"	15	150	165
10001054	50 x 1 1/4"	10	90	110
10001055	50 x 1 1/2"	10	90	100
10001056	50 x 2"	10	90	100
10001065	63 x 1 1/2"	6	60	66
10001066	63 x 2"	6	54	60
10001067	63 x 2 1/2"	6	54	54
10001076	75 x 2"	4	32	36
10001077	75 x 2 1/2"	4	32	32
10001078	75 x 3"	4	32	32
10001086	90 x 2"	4	20	20
10001087	90 x 2 1/2"	4	16	20
10001088	90 x 3"	4	16	20
10001089	90 x 4"	4	16	20
10001095	110 x 2"	2	12	14
10001096	110 x 2 1/2"	2	12	14
10001097	110 x 3"	2	12	14
10001098	110 x 4"	2	12	14

KOD CODE	EBAT / SIZE d x d	AMBALAJ ADEDİ PACKING QUANTITY	KOLİ ADEDİ BOX QUANTITY	ÇUVAL ADEDİ SACK QUANTITY
10002011	20 x 20	25	400	450
10002022	25 x 25	25	300	325
10002033	32 x 32	10	170	180
10002044	40 x 40	10	90	110
10002055	50 x 50	6	60	66
10002066	63 x 63	5	35	35
10002077	75 x 75	2	18	20
10002088	90 x 90	2	10	12
10002099	110 x 110	1	8	9



KABLİN ERKEK

MALE ADAPTOR
МУФТА С НАРУЖНОЙ
РЕЗЬБОЙ
بداية سن خارج

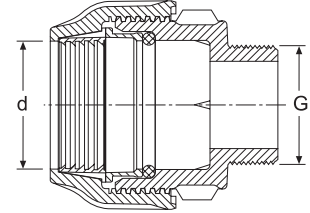

KABLİN MANŞON

COUPLING
МУФТА СОЕДИНИТЕЛЬНАЯ
رباطة

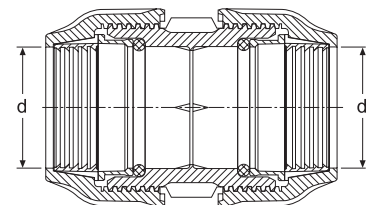

سلسلة الزرقاء / СИНЯЯ СЕРИЯ



KABLİN TE

TEE
ТРОЙНИК
تقسيم

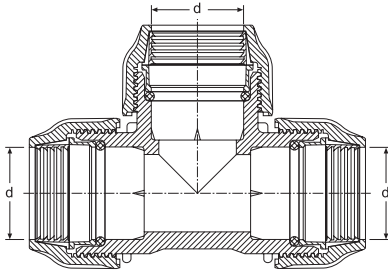

KABLİN ERKEK TE

MALE TEE
ТРОЙНИК С НАРУЖНОЙ
РЕЗЬБОЙ
تقسيم سن خارج

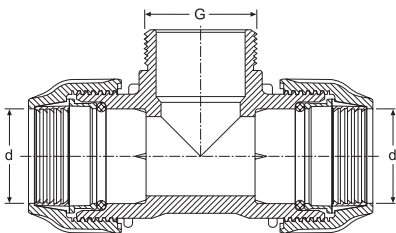

KOD CODE	EBAT / SIZE d x d x d	AMBALAJ ADEDİ PACKING QUANTITY	KOLİ ADEDİ BOX QUANTITY	ÇUVAL ADEDİ SACK QUANTITY
10002511	20 x 20 x 20	15	240	255
10002522	25 x 25 x 25	10	150	160
10002533	32 x 32 x 32	5	80	90
10002544	40 x 40 x 40	5	50	55
10002555	50 x 50 x 50	4	28	32
10002566	63 x 63 x 63	3	18	21
10002577	75 x 75 x 75	1	10	12
10002588	90 x 90 x 90	1	5	6
10002599	110 x 110 x 110	1	3	4

KOD CODE	EBAT / SIZE d x G x d	AMBALAJ ADEDİ PACKING QUANTITY	KOLİ ADEDİ BOX QUANTITY	ÇUVAL ADEDİ SACK QUANTITY
10003011	20 x 1/2" x 20	15	300	330
10003012	20 x 3/4" x 20	15	300	330
10003021	25 x 1/2" x 25	10	200	220
10003022	25 x 3/4" x 25	10	200	230
10003023	25 x 1" x 25	10	180	200
10003032	32 x 3/4" x 32	10	120	140
10003033	32 x 1" x 32	10	110	120
10003034	32 x 1 1/4" x 32	10	100	120
10003043	40 x 1" x 40	5	75	80
10003044	40 x 1 1/4" x 40	5	60	75
10003045	40 x 1 1/2" x 40	5	55	65
10003053	50 x 1" x 50	4	44	52
10003054	50 x 1 1/4" x 50	4	44	48
10003055	50 x 1 1/2" x 50	4	40	44
10003056	50 x 2" x 50	4	32	40
10003064	63 x 1 1/4" x 63	3	27	30
10003065	63 x 1 1/2" x 63	3	24	30
10003066	63 x 2" x 63	3	21	27
10003067	63 x 2 1/2" x 63	3	18	24
10003076	75 x 2" x 75	1	16	17
10003077	75 x 2 1/2" x 75	1	14	15
10003078	75 x 3" x 75	1	12	13
10003086	90 x 2" x 90	1	9	10
10003087	90 x 2 1/2" x 90	1	8	10
10003088	90 x 3" x 90	1	8	10
10003089	90 x 4" x 90	1	6	8
10003096	110 x 2 1/2" x 110	1	6	6
10003097	110 x 3" x 110	1	5	5
10003098	110 x 4" x 110	1	5	5

KOD CODE	EBAT / SIZE d x d	AMBALAJ ADEDİ PACKING QUANTITY	KOLİ ADEDİ BOX QUANTITY	ÇUVAL ADEDİ SACK QUANTITY
10004011	20 x 20	25	400	450
10004022	25 x 25	15	240	255
10004033	32 x 32	10	140	160
10004044	40 x 40	5	80	90
10004055	50 x 50	4	44	52
10004066	63 x 63	4	28	32
10004077	75 x 75	2	16	18
10004088	90 x 90	1	8	10
10004099	110 x 110	1	5	6



KABLİN DİRSEK

ELBOW

Отвод

عكس

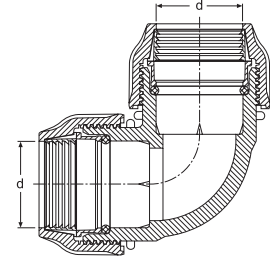

KOD CODE	EBAT / SIZE d x G	AMBALAJ ADEDİ PACKING QUANTITY	KOLİ ADEDİ BOX QUANTITY	ÇUVAL ADEDİ SACK QUANTITY
10004511	20 x 1/2"	25	600	700
10004512	20 x 3/4"	25	550	600
10004521	25 x 1/2"	15	390	420
10004522	25 x 3/4"	15	390	420
10004523	25 x 1"	15	330	360
10004532	32 x 3/4"	10	240	250
10004533	32 x 1"	10	220	240
10004534	32 x 1 1/4"	10	200	200
10004543	40 x 1"	5	120	140
10004544	40 x 1 1/4"	5	120	130
10004545	40 x 1 1/2"	5	110	125
10004554	50 x 1 1/4"	4	72	80
10004555	50 x 1 1/2"	4	72	80
10004556	50 x 2"	4	64	72
10004565	63 x 1 1/2"	4	44	52
10004566	63 x 2"	4	40	48
10004567	63 x 2 1/2"	4	36	44
10004576	75 x 2"	2	24	28
10004577	75 x 2 1/2"	2	24	24
10004578	75 x 3"	2	20	24
10004587	90 x 2 1/2"	1	14	17
10004588	90 x 3"	1	14	17
10004589	90 x 4"	1	12	14
10004597	110 x 3"	1	8	11
10004598	110 x 4"	1	8	10



KABLİN ERKEK DİRSEK

MALE ELBOW

УГОЛ С НАРУЖНОЙ РЕЗЬБОЙ

عكس سن خارج

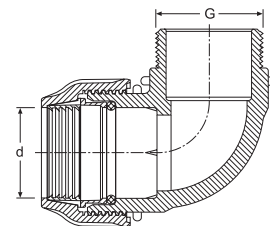



KABLİN REDÜKSİYON TE

REDUCING TEE
ПЕРЕХОДНОЙ ТРОЙНИК

تقسم مصغرة

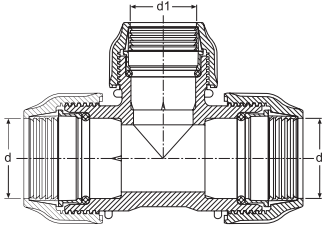

KOD CODE	EBAT / SIZE d x d, x d	AMBALAJ ADEDİ PACKING QUANTITY	KOLİ ADEDİ BOX QUANTITY	ÇUVAL ADEDİ SACK QUANTITY
10005521	25 x 20 x 25	10	180	200
10005531	32 x 20 x 32	5	120	120
10005532	32 x 25 x 32	5	100	115
10005542	40 x 25 x 40	5	65	75
10005543	40 x 32 x 40	5	55	65
10005552	50 x 25 x 50	4	40	44
10005553	50 x 32 x 50	4	40	44
10005554	50 x 40 x 50	4	40	40
10005562	63 x 25 x 63	3	24	30
10005563	63 x 32 x 63	3	24	30
10005564	63 x 40 x 63	3	21	24
10005565	63 x 50 x 63	3	21	24
10005575	75 x 50 x 75	1	14	14
10005576	75 x 63 x 75	1	12	14
10005586	90 x 63 x 90	1	8	9
10005587	90 x 75 x 90	1	7	8
10005596	110 x 63 x 110	1	6	6
10005597	110 x 75 x 110	1	4	5
10005598	110 x 90 x 110	1	4	5



KABLİN REDÜKSİYON MANŞON

REDUCING COUPLING
МУФТА ПЕРЕХОДНАЯ

رباطة مصغرة

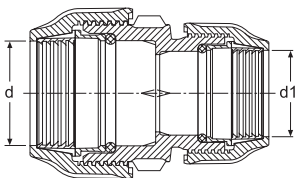

KOD CODE	EBAT / SIZE d x d ₁	AMBALAJ ADEDİ PACKING QUANTITY	KOLİ ADEDİ BOX QUANTITY	ÇUVAL ADEDİ SACK QUANTITY
10006021	25 x 20	25	350	400
10006031	32 x 20	10	240	270
10006032	32 x 25	10	200	240
10006041	40 x 20	10	150	170
10006042	40 x 25	10	140	160
10006043	40 x 32	10	120	130
10006052	50 x 25	6	90	102
10006053	50 x 32	6	84	96
10006054	50 x 40	6	72	78
10006062	63 x 25	6	54	60
10006063	63 x 32	6	48	60
10006064	63 x 40	6	48	54
10006065	63 x 50	6	36	48
10006075	75 x 50	2	28	32
10006076	75 x 63	2	24	24
10006086	90 x 63	2	14	18
10006087	90 x 75	2	12	16
10006096	110 x 63	1	10	14
10006097	110 x 75	1	8	11
10006098	110 x 90	1	8	10

KOD CODE	EBAT / SIZE d x d ₁	AMBALAJ ADEDİ PACKING QUANTITY	KOLİ ADEDİ BOX QUANTITY	ÇUVAL ADEDİ SACK QUANTITY
10006521	25 x 20	15	270	300
10006532	32 x 25	10	180	200
10006543	40 x 32	5	90	100
10006554	50 x 40	4	52	68
10006565	63 x 50	4	32	40
10006576	75 x 63	2	18	22
10006587	90 x 75	1	11	14
10006598	110 x 90	1	6	8



KABLİN REDÜKSİYON DİRSEK

REDUCING ELBOW
УГОЛ ПЕРЕХОДНОЙ
عكس مصغرة

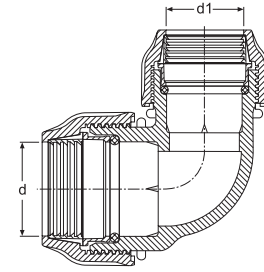

KOD CODE	EBAT / SIZE d	AMBALAJ ADEDİ PACKING QUANTITY	KOLİ ADEDİ BOX QUANTITY	ÇUVAL ADEDİ SACK QUANTITY
10007011	20	50	800	900
10007022	25	25	500	550
10007033	32	25	300	350
10007044	40	15	165	180
10007055	50	12	96	108
10007066	63	6	60	60
10007077	75	4	32	36
10007088	90	4	16	20
10007099	110	2	12	16



KABLİN KÖR TAPA

END CAP
ЗАГЛУШКА
سدادة

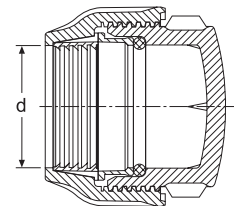

MAVİ SERİ / BLUE SERIES COMPRESSION FITTINGS

سلسلة الزرقاء / СИНЯЯ СЕРИЯ



TAMİR MANŞONU

REPAIRING COUPLING

РЕМОНТНАЯ МУФТА

رباطة مصلحة

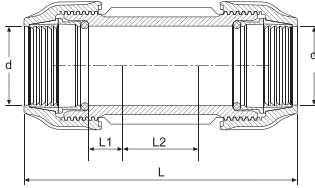

KOD CODE	EBAT SIZE	AMBALAJ ADEDİ PACKING QUANTITY	KOLİ ADEDİ BOX QUANTITY	ÇUVAL ADEDİ SACK QUANTITY	L	L ₁	L ₂
10009011	20	25	350	400	100	14.5	25
10009022	25	25	200	250	115	14.5	30
10009033	32	10	120	140	140	16.0	40
10009044	40	10	60	70	168	19.0	50
10009055	50	6	36	48	183	21.5	60
10009066	63	4	24	28	225	25.0	70
10009077	75	2	14	16	260	30.0	80
10009088	90	2	8	10	310	35.5	100
10009099	110	1	5	6	355	41.0	115



KABLİN ANAHTARI

FITTING SPANNER

соединительный ключ

مفتاح مواد ربط

MAVİ SERİ KABLİN ANAHTAR (Blue Series Fitting Spanner)

KOD CODE	EBAT SIZE	AMBALAJ ADEDİ PACKING QUANTITY	KOLİ ADEDİ BOX QUANTITY	ÇUVAL ADEDİ SACK QUANTITY
10009511	20	5	600	700
10009522	25	5	500	550
10009533	32	5	400	400
10009544	40	5	300	300
10009555	50	5	230	250
10009566	63	5	180	200
10009577	75	5	110	110
10009588	90	5	75	75
10009599	110	5	50	50

MAVİ SERİ (125") / BLUE SERIES (125") COMPRESSION FITTINGS



TS ISO 17885



GARANTİ VERİLEN BASINÇ DEĞERİ
GUARANTEED PRESSURE VALUE
Ø 125 mm: PN 10

سلسلة الزرقاء / МАВІ СЕРІЯ

KOD CODE	EBAT/SIZE d x G	ÜRÜN PRODUCT	AMBALAJ ADEDİ PACKING QUANTITY	KOLİ ADEDİ BOX QUANTITY	ÇUVAL ADEDİ SACK QUANTITY
109910	125 x 5"	KABLİN ERKEK / MALE ADAPTOR	2	8	8
159910	125 x 5"	KABLİN DIŞI / FEMALE ADAPTOR	2	6	8
209999	125 x 125	KABLİN MANŞON / COUPLING	1	4	5
259999	125 x 125 x 125	KABLİN TE / TEE	1	2	2
309909	125 x 4" x 125	KABLİN ERKEK TE / MALE TEE	1	2	3
309910	125 x 5" x 125	KABLİN ERKEK TE / MALE TEE	1	2	3
359910	125 x 5" x 125	KABLİN DIŞI TE / FEMALE TEE	1	2	3
409999	125 x 125	KABLİN DİRSEK / ELBOW	1	4	4
459910	125 x 5"	KABLİN ERKEK DİRSEK / MALE ELBOW	1	5	6
509910	125 x 5"	KABLİN DIŞI DİRSEK / FEMALE ELBOW	1	4	6
559909	125 x 110 x 125	KABLİN REDÜKSİYON TE / REDUCING TEE	1	2	2
609909	125 x 110	KABLİN REDÜKSİYON MANŞON / REDUCING COUPLING	1	5	5
659999	125	KABLİN KÖR TAPA / END CAP	2	8	8

KOD CODE	EBAT/SIZE d x G	AMBALAJ ADEDİ PACKING QUANTITY	KOLİ ADEDİ BOX QUANTITY	ÇUVAL ADEDİ SACK QUANTITY
49699	125	2	24	22



KABLİN ANAHTARI

FITTING SPANNER

соединительный ключ

مفتاح مواد ربط

ISO 17885 STANDARDI - TESTLER

ISO 17885 STANDARD - TESTS

PLASTİK MALZEMENİN UZUN VADEDE DAVRANIŞININ DOĞRULANMASI
Ekleme parçalarının gövdeleri, ISO 1167-1 test standardına göre test edilmektedir.

VERIFICATION OF LONG-TERM BEHAVIOUR OF THE PLASTIC MATERIAL
Compression fittings bodies are tested according to the ISO 1167-1 test standard.

MALZEME MATERIAL	TEST SICAKLIĞI / °C TEST TEMPERATURE	TEST SÜRESİ / SAAT TEST DURATION / HOUR	TEST BASINCI / BAR TEST PRESSURE PN 16
PP-B	20	1	40.6
	95	1.000	6.6
PP-H	20	1	53.3
	95	1.000	9.1

İÇ BASINÇ ALTINDA UZUN SÜRELİ SIZDIRMAZLIK

Montajlanmış ekleme parçaları, ISO 3458, ISO 1167-1, ISO 1167-4 test standardına göre test edilmektedir.

LONG-TERM LEAKPROOFNESS UNDER INTERNAL PRESSURE

Assembled fittings are tested according to the ISO 3458, ISO 1167-1, ISO 1167-4 test standard.

TEST SICAKLIĞI / °C TEST TEMPERATURE	TEST SÜRESİ / SAAT TEST DURATION / HOUR	TEST BASINCI / BAR TEST PRESSURE PN 16
20	1.000	19.2





23 °C SICAKLIKTA AYRILMA DİRENCİ

PE boru ile montajlanmış ekleme parçaları, ISO 3501 test standardına göre test edilmektedir.

RESISTANCE TO PULL-OUT AT 23 °C

Compression fittings, assembled with PE pipes, are tested according to the ISO 3501 test standard.

PN 16 Grubu için Çekme Kuvveti (Newton) Pull Force for PN 16 Group (Newton)

Ø20	Ø25	Ø32	Ø40	Ø50	Ø63	Ø75	Ø90	Ø110
1.119	1.686	2.704	4.175	6.492	10.313	14.416	20.086	31.086

İÇ BASINÇ ALTINDA SIZDIRMAZLIK

Montajlanmış ekleme parçaları, ISO 3458 test standardına göre test edilmektedir.

LEAKPROOFNESS UNDER INTERNAL PRESSURE

Assembled fittings are tested according to the ISO 3458 test standard.

TEST SICAKLIĞI / °C
TEST TEMPERATURE

20 ± 5

TEST SÜRESİ / SAAT
TEST DURATION / HOUR

1

TEST BASINCI / BAR
TEST PRESSURE
PN 16

24,0

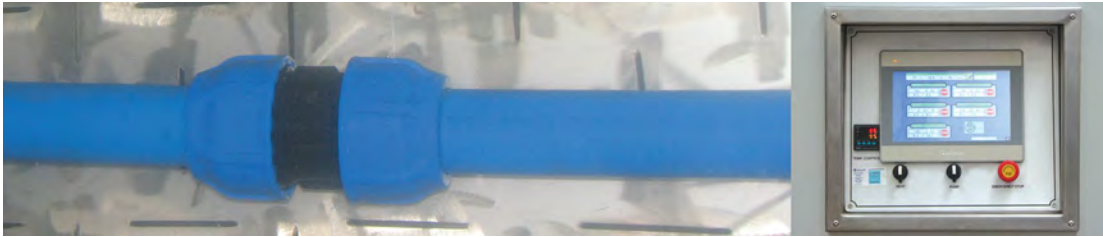

BÜKÜLÜ İKEN İÇ BASINÇ ALTINDA SIZDIRMAZLIK

Montajlanmış ekleme parçaları, ISO 3503 test standardına göre test edilmektedir.

LEAKPROOFNESS UNDER INTERNAL PRESSURE WHEN SUBJECTED TO BENDING

Assembled fittings are tested according to the ISO 3503 test standard.

TEST SICAKLIĞI / °C
TEST TEMPERATURE

23 ± 2

TEST SÜRESİ / SAAT
TEST DURATION / HOUR

1

TEST BASINCI / BAR
TEST PRESSURE
PN 16

24,0

DİŞLER Ekleme parçaları için dişler, ISO 7-1 standardına uygundur.

THREADS Threads for compression fittings are covered by ISO 7-1 standard.

SU KALİTESİ ÜZERİNDEKİ ETKİSİ Ekleme parçaları, içme suyu üzerinde mikroorganizmaların çoğalmalarına izin vermemelidir. KIWA ve TSE kuruluşlarının laboratuvarları tarafından ilgili testler yapılarak raporlandırılmıştır.

INFLUENCE ON WATER QUALITY Compression fittings must not allow increasing microorganism on drinking water. It is reported with the related tests by the laboratories of KIWA and TSE Institutions.

YEŞİL SERİ

GREEN SERIES
ЗЕЛЕНАЯ СЕРИЯ
سلسلة الخضراء

Özellikler

- + Darbelere karşı dayanıklı, yüksek kaliteli polipropilen hammaddeden üretilmiştir.
- + Borulardaki ölçü farklılıklarından veya ovalikten oluşabilecek sorunları konik sıkma özelliği sayesinde önler.
- + UV ışınlarını geçirmediği için yosunlanmaya ve bakteri üremesine izin vermez.
- + Oringi kauçuktan üretilmekte olup yüksek basınç altında sızdırmazlık sağlar.
- + İç yüzeyleri homojen ve gözeneksizdir.
- + Suyun kokusunu ve tadını değiştirebilecek zararlı bileşikler içermez.
- + Dişi ürünlerimiz, korozyona dayanıklı metal yüzük sayesinde değişken sıcaklıklarda yüksek sızdırmazlık sağlar.
- + Diş ölçüleri ISO 7-1 Standardına uygundur.
- + ISO 17885 Standardına uygundur.

Specifications

- + It has been produced from high quality polypropylene raw material and it has resistance to impact.
- + Thanks to the conical tightening feature, it prevents the problems that may occur because of the size differences or ovality in pipes.
- + They prevent alga and bacteria forming due to UV proof (ultraviolet beam) structure.
- + O-rings are made of rubber and provide leakproofness under high pressure.
- + It has a homogeneous and non-porous inner surface.
- + It does not contain any harmful compounds which can change the taste or the smell of the water.
- + Female threaded products provide high leakproofness in changeable temperature values thanks to corrosion resistant reinforcing ring.
- + Thread sizes are compatible with ISO 7-1 Standard.
- + It is compatible with ISO 17885 Standard.



TS ISO 17885

GARANTİ VERİLEN BASINÇ DEĞERİ
GUARANTEED PRESSURE VALUE
Ø 20 mm - Ø 110 mm: PN 6

KULLANIM ALANLARI

- + Peyzaj Sektörü
- + Tarımsal Sulama
- + Seralar

INSTALLATION AREAS

- + Landscaping Systems
- + Agricultural Irrigation
- + Greenhouses

KOD CODE	EBAT / SIZE d x G	AMBALAJ ADEDİ PACKING QUANTITY	KOLİ ADEDİ BOX QUANTITY	ÇUVAL ADEDİ SACK QUANTITY
YS7211	20 x 1/2"			
YS7212	20 x 3/4"			
YS7221	25 x 1/2"			
YS7222	25 x 3/4"			
YS7223	25 x 1"			
YS7232	32 x 3/4"			
YS7233	32 x 1"			
YS7234	32 x 1 1/4"			
YS7243	40 x 1"			
YS7244	40 x 1 1/4"			
YS7245	40 x 1 1/2"			
YS7254	50 x 1 1/4"			
YS7255	50 x 1 1/2"			
YS7256	50 x 2"			
YS7265	63 x 1 1/2"			
YS7266	63 x 2"			
YS7267	63 x 2 1/2"			
YS7276	75 x 2"			
YS7277	75 x 2 1/2"			
YS7278	75 x 3"			
YS7286	90 x 2"			
YS7287	90 x 2 1/2"			
YS7288	90 x 3"			
YS7289	90 x 4"			
YS7298	110 x 3"			
YS7299	110 x 4"			

KOD CODE	EBAT / SIZE d x G x d	AMBALAJ ADEDİ PACKING QUANTITY	KOLİ ADEDİ BOX QUANTITY	ÇUVAL ADEDİ SACK QUANTITY
YS7811	20 x 1/2" x 20			
YS7812	20 x 3/4" x 20			
YS7821	25 x 1/2" x 25			
YS7822	25 x 3/4" x 25			
YS7823	25 x 1" x 25			
YS7831	32 x 1/2" x 32			
YS7832	32 x 3/4" x 32			
YS7833	32 x 1" x 32			
YS7834	32 x 1 1/4" x 32			
YS7842	40 x 3/4" x 40			
YS7843	40 x 1" x 40			
YS7844	40 x 1 1/4" x 40			
YS7845	40 x 1 1/2" x 40			
YS7852	50 x 3/4" x 50			
YS7853	50 x 1" x 50			
YS7854	50 x 1 1/4" x 50			
YS7855	50 x 1 1/2" x 50			
YS7856	50 x 2" x 50			
YS7863	63 x 1" x 63			
YS7864	63 x 1 1/4" x 63			
YS7865	63 x 1 1/2" x 63			
YS7866	63 x 2" x 63			
YS7867	63 x 2 1/2" x 63			
YS7876	75 x 2" x 75			
YS7877	75 x 2 1/2" x 75			
YS7878	75 x 3" x 75			
YS7887	90 x 2 1/2" x 90			
YS7888	90 x 3" x 90			
YS7889	90 x 4" x 90			
YS7898	110 x 3" x 110			
YS7899	110 x 4" x 110			



KABLİN DİŞİ
FEMALE ADAPTOR
МУФТА С ВНУТРЕННЕЙ РЕЗЬБОЙ
أنثى المحملة

GALVANİZ METAL YÜZÜKLÜ
GALVANIZED REINFORCING RING
ОЦИНКОВАННОЕ АРМИРУЮЩЕЕ КОЛЬЦО
بداية سن داخل مع حلقة مدعمة كلفنايز

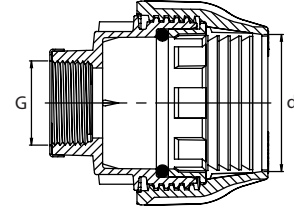

KABLİN DİŞİ TE
FEMALE TEE
ЖЕНСКИЙ ТРОЙНИК
أنثى المحملة

GALVANİZ METAL YÜZÜKLÜ
GALVANIZED REINFORCING RING
ОЦИНКОВАННОЕ АРМИРУЮЩЕЕ КОЛЬЦО
تقسيم سن داخل مع حلقة مدعمة كلفنايز

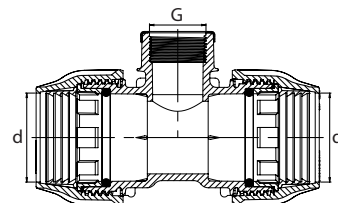



KABLİN DIŞI DİRSEK

FEMALE ELBOW

ЖЕНСКИЙ ЛОКОТЬ

عكس سن داخل

GALVANİZ METAL YÜZÜKLÜ

GALVANIZED REINFORCING RING

ОЦИНКОВАННОЕ АРМИРУЮЩЕЕ КОЛЬЦО

عكس سن داخل مع حلقة مدعمة كلفنايز

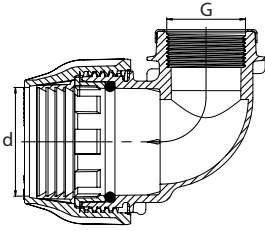

KOD CODE	EBAT / SIZE d x G	AMBALAJ ADEDİ PACKING QUANTITY	KOLİ ADEDİ BOX QUANTITY	ÇUVAL ADEDİ SACK QUANTITY
YS8311	20 x 1/2"			
YS8312	20 x 3/4"			
YS8321	25 x 1/2"			
YS8322	25 x 3/4"			
YS8323	25 x 1"			
YS8332	32 x 3/4"			
YS8333	32 x 1"			
YS8334	32 x 1 1/4"			
YS8343	40 x 1"			
YS8344	40 x 1 1/4"			
YS8345	40 x 1 1/2"			
YS8354	50 x 1 1/4"			
YS8355	50 x 1 1/2"			
YS8356	50 x 2"			
YS8365	63 x 1 1/2"			
YS8366	63 x 2"			
YS8367	63 x 2 1/2"			
YS8376	75 x 2"			
YS8377	75 x 2 1/2"			
YS8378	75 x 3"			
YS8387	90 x 2 1/2"			
YS8388	90 x 3"			
YS8389	90 x 4"			
YS8398	110 x 3"			
YS8399	110 x 4"			

+ Termin Süresi ve Ambalaj Bilgileri İçin Lütfen Bizi Arayınız.



YEŞİL SERİ / GREEN SERIES COMPRESSION FITTINGS

KOD CODE	EBAT / SIZE d x G	AMBALAJ ADEDİ PACKING QUANTITY	KOLİ ADEDİ BOX QUANTITY	ÇUVAL ADEDİ SACK QUANTITY
YS7111	20 x 1/2"			
YS7112	20 x 3/4"			
YS7121	25 x 1/2"			
YS7122	25 x 3/4"			
YS7123	25 x 1"			
YS7131	32 x 1/2"			
YS7132	32 x 3/4"			
YS7133	32 x 1"			
YS7134	32 x 1 1/4"			
YS7143	40 x 1"			
YS7144	40 x 1 1/4"			
YS7145	40 x 1 1/2"			
YS7154	50 x 1 1/4"			
YS7155	50 x 1 1/2"			
YS7156	50 x 2"			
YS7165	63 x 1 1/2"			
YS7166	63 x 2"			
YS7167	63 x 2 1/2"			
YS7176	75 x 2"			
YS7177	75 x 2 1/2"			
YS7178	75 x 3"			
YS7186	90 x 2"			
YS7187	90 x 2 1/2"			
YS7188	90 x 3"			
YS7189	90 x 4"			
YS7198	110 x 3"			
YS7199	110 x 4"			

KOD CODE	EBAT / SIZE d x d	AMBALAJ ADEDİ PACKING QUANTITY	KOLİ ADEDİ BOX QUANTITY	ÇUVAL ADEDİ SACK QUANTITY
YS7311	20 x 20			
YS7322	25 x 25			
YS7333	32 x 32			
YS7344	40 x 40			
YS7355	50 x 50			
YS7366	63 x 63			
YS7377	75 x 75			
YS7388	90 x 90			
YS7399	110 x 110			



KABLİN ERKEK
MALE ADAPTOR
МУФТА С НАРУЖНОЙ
РЕЗЬБОЙ

بداية سن خارج

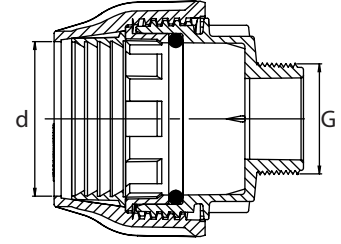

KABLİN MANŞON
COUPLING
МУФТА СОЕДИНИТЕЛЬНАЯ
رباطة

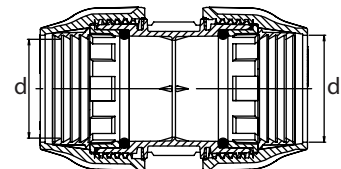

سلسلة الخضراء / ЗЕЛЕНАЯ СЕРИЯ

+ Termin Süresi ve Ambalaj Bilgileri İçin Lütfen Bizi Arayınız.

YEŞİL SERİ / GREEN SERIES COMPRESSION FITTINGS

سلسلة الخضراء / ZELENAJA SERIJA



KABLİN TE

TEE
ТРОЙНИК
تقسيم

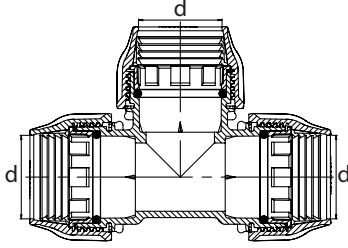

KOD CODE	EBAT / SIZE d x d x d	AMBALAJ ADEDİ PACKING QUANTITY	KOLİ ADEDİ BOX QUANTITY	ÇUVAL ADEDİ SACK QUANTITY
YS7611	20 x 20 x 20			
YS7622	25 x 25 x 25			
YS7633	32 x 32 x 32			
YS7644	40 x 40 x 40			
YS7655	50 x 50 x 50			
YS7666	63 x 63 x 63			
YS7677	75 x 75 x 75			
YS7688	90 x 90 x 90			
YS7699	110 x 110 x 110			



KABLİN ERKEK TE

MALE TEE
ТРОЙНИК С НАРУЖНОЙ
РЕЗЬБОЙ
تقسيم سن خارج

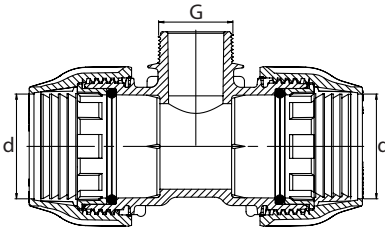

KOD CODE	EBAT / SIZE d x G x d	AMBALAJ ADEDİ PACKING QUANTITY	KOLİ ADEDİ BOX QUANTITY	ÇUVAL ADEDİ SACK QUANTITY
YS7711	20 x 1/2" x 20			
YS7712	20 x 3/4" x 20			
YS7721	25 x 1/2" x 25			
YS7722	25 x 3/4" x 25			
YS7723	25 x 1" x 25			
YS7724	25 x 1 1/4" x 25			
YS7732	32 x 3/4" x 32			
YS7733	32 x 1" x 32			
YS7734	32 x 1 1/4" x 32			
YS7743	40 x 1" x 40			
YS7744	40 x 1 1/4" x 40			
YS7745	40 x 1 1/2" x 40			
YS7753	50 x 1" x 50			
YS7754	50 x 1 1/4" x 50			
YS7755	50 x 1 1/2" x 50			
YS7756	50 x 2" x 50			
YS7764	63 x 1 1/4" x 63			
YS7765	63 x 1 1/2" x 63			
YS7766	63 x 2" x 63			
YS7767	63 x 2 1/2" x 63			
YS7776	75 x 2" x 75			
YS7777	75 x 2 1/2" x 75			
YS7778	75 x 3" x 75			
YS7787	90 x 2 1/2" x 90			
YS7788	90 x 3" x 90			
YS7789	90 x 4" x 90			
YS7798	110 x 3" x 110			
YS7799	110 x 4" x 110			

+ Termin Süresi ve Ambalaj Bilgileri İçin Lütfen Bizi Arayınız.

YEŞİL SERİ / GREEN SERIES COMPRESSION FITTINGS

KOD CODE	EBAT / SIZE d x d	AMBALAJ ADEDİ PACKING QUANTITY	KOLİ ADEDİ BOX QUANTITY	ÇUVAL ADEDİ SACK QUANTITY
YS8111	20 x 20			
YS8122	25 x 25			
YS8133	32 x 32			
YS8144	40 x 40			
YS8155	50 x 50			
YS8166	63 x 63			
YS8177	75 x 75			
YS8188	90 x 90			
YS8199	110 x 110			

KOD CODE	EBAT / SIZE d x G	AMBALAJ ADEDİ PACKING QUANTITY	KOLİ ADEDİ BOX QUANTITY	ÇUVAL ADEDİ SACK QUANTITY
YS8211	20 x 1/2"			
YS8212	20 x 3/4"			
YS8221	25 x 1/2"			
YS8222	25 x 3/4"			
YS8223	25 x 1"			
YS8232	32 x 3/4"			
YS8233	32 x 1"			
YS8234	32 x 1 1/4"			
YS8243	40 x 1"			
YS8244	40 x 1 1/4"			
YS8245	40 x 1 1/2"			
YS8254	50 x 1 1/4"			
YS8255	50 x 1 1/2"			
YS8256	50 x 2"			
YS8265	63 x 1 1/2"			
YS8266	63 x 2"			
YS8267	63 x 2 1/2"			
YS8276	75 x 2"			
YS8277	75 x 2 1/2"			
YS8278	75 x 3"			
YS8287	90 x 2 1/2"			
YS8288	90 x 3"			
YS8289	90 x 4"			
YS8298	110 x 3"			
YS8299	110 x 4"			



KABLİN DİRSEK

ELBOW

Отвод

عكس

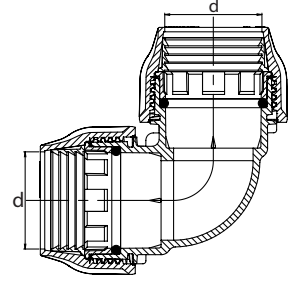

KABLİN ERKEK DİRSEK

MALE ELBOW

УГОЛ С НАРУЖНОЙ

РЕЗЬБОЙ

عكس سن خارج

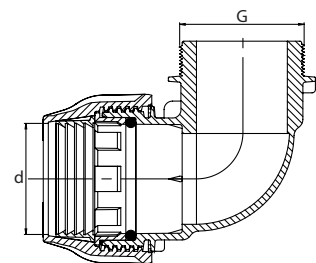

سلسلة الخضراء / ЗЕЛЕНАЯ СЕРИЯ

+ Termin Süresi ve Ambalaj Bilgileri İçin Lütfen Bizi Arayınız.

YEŞİL SERİ / GREEN SERIES COMPRESSION FITTINGS

سلسلة الخضراء / ЗЕЛЕНАЯ СЕРИЯ



KABLİN REDÜKSİYON TE

REDUCING TEE
ПЕРЕХОДНОЙ ТРОЙНИК
تقسم مصغرة

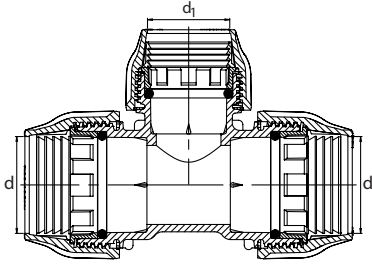

KOD CODE	EBAT / SIZE d x d ₁ x d	AMBALAJ ADEDİ PACKING QUANTITY	KOLİ ADEDİ BOX QUANTITY	ÇUVAL ADEDİ SACK QUANTITY
YS8612	20 x 25 x 20			
YS8621	25 x 20 x 25			
YS8623	25 x 32 x 25			
YS8631	32 x 20 x 32			
YS8632	32 x 25 x 32			
YS8642	40 x 25 x 40			
YS8643	40 x 32 x 40			
YS8652	50 x 25 x 50			
YS8653	50 x 32 x 50			
YS8654	50 x 40 x 50			
YS8663	63 x 32 x 63			
YS8664	63 x 40 x 63			
YS8665	63 x 50 x 63			
YS8675	75 x 50 x 75			
YS8676	75 x 63 x 75			
YS8686	90 x 63 x 90			
YS8687	90 x 75 x 90			
YS8696	110 x 63 x 110			
YS8698	110 x 90 x 110			



KABLİN REDÜKSİYON MANŞON

REDUCING COUPLING
МУФТА ПЕРЕХОДНАЯ
رباطة مصغرة

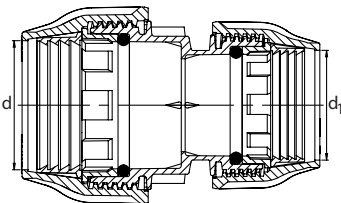

KOD CODE	EBAT / SIZE d x d ₁	AMBALAJ ADEDİ PACKING QUANTITY	KOLİ ADEDİ BOX QUANTITY	ÇUVAL ADEDİ SACK QUANTITY
YS8721	25 x 20			
YS8731	32 x 20			
YS8732	32 x 25			
YS8741	40 x 20			
YS8742	40 x 25			
YS8743	40 x 32			
YS8752	50 x 25			
YS8753	50 x 32			
YS8754	50 x 40			
YS8763	63 x 32			
YS8764	63 x 40			
YS8765	63 x 50			
YS8775	75 x 50			
YS8776	75 x 63			
YS8786	90 x 63			
YS8787	90 x 75			
YS8797	110 x 75			
YS8798	110 x 90			

+ Termin Süresi ve Ambalaj Bilgileri İçin Lütfen Bizi Arayınız.

KOD CODE	EBAT / SIZE d x d ₁	AMBALAJ ADEDİ PACKING QUANTITY	KOLİ ADEDİ BOX QUANTITY	ÇUVAL ADEDİ SACK QUANTITY
YS8921	25 x 20			
YS8932	32 x 25			
YS8943	40 x 32			
YS8954	50 x 40			
YS8965	63 x 50			
YS8976	75 x 63			
YS8987	90 x 75			
YS8998	110 x 90			



**KABLİN
REDÜKSİYON DİRSEK**
REDUCING ELBOW
УГОЛ ПЕРЕХОДНОЙ

عكس مصغرة

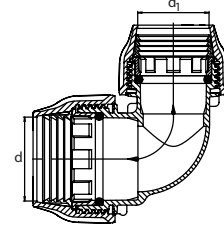

KOD CODE	EBAT / SIZE d	AMBALAJ ADEDİ PACKING QUANTITY	KOLİ ADEDİ BOX QUANTITY	ÇUVAL ADEDİ SACK QUANTITY
YS8811	20			
YS8822	25			
YS8833	32			
YS8844	40			
YS8855	50			
YS8866	63			
YS8877	75			
YS8888	90			
YS8899	110			



KABLİN KÖR TAPA

END CAP
ЗАГЛУШКА
سدادة

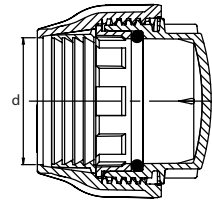

KABLİN ANAHTARI

FITTING SPANNER
соединительный ключ
مفتاح مواد ربط

KOD CODE	EBAT SIZE-mm	AMBALAJ ADEDİ PACKING QUANTITY	KOLİ ADEDİ BOX QUANTITY	ÇUVAL ADEDİ SACK QUANTITY
4936	32 - 63	5	150	150
4969	63 - 110	5	45	50

+ Termin Süresi ve Ambalaj Bilgileri İçin Lütfen Bizi Arayınız.

ISO 17885 STANDARTI - TESTLER

ISO 17885 STANDARD - TESTS

PLASTİK MALZEMENİN UZUN VADEDE DAVRANIŞININ DOĞRULANMASI

Ekleme parçalarının gövdeleri, ISO 1167-1 test standardına göre test edilmektedir.

VERIFICATION OF LONG-TERM BEHAVIOUR OF THE PLASTIC MATERIAL

Compression fittings bodies are tested according to the ISO 1167-1 test standard.

MALZEME MATERIAL	TEST SICAKLIĞI / °C TEST TEMPERATURE	TEST SÜRESİ / SAAT TEST DURATION / HOUR	TEST BASINCI / BAR TEST PRESSURE PN 6
PP-H	<u>20</u> 95	<u>1</u> 1.000	<u>20.0</u> 3.4

İÇ BASINÇ ALTINDA UZUN SÜRELİ SIZDIRMAZLIK

Montajlanmış ekleme parçaları, ISO 3458, ISO 1167-1, ISO 1167-4 test standardına göre test edilmektedir.

LONG-TERM LEAKPROOFNESS UNDER INTERNAL PRESSURE

Assembled fittings are tested according to the ISO 3458, ISO 1167-1, ISO 1167-4 test standard.

TEST SICAKLIĞI / °C TEST TEMPERATURE	TEST SÜRESİ / SAAT TEST DURATION / HOUR	TEST BASINCI / BAR TEST PRESSURE PN 6
<u>20 ± 5</u>	<u>1.000</u>	<u>7.2</u>



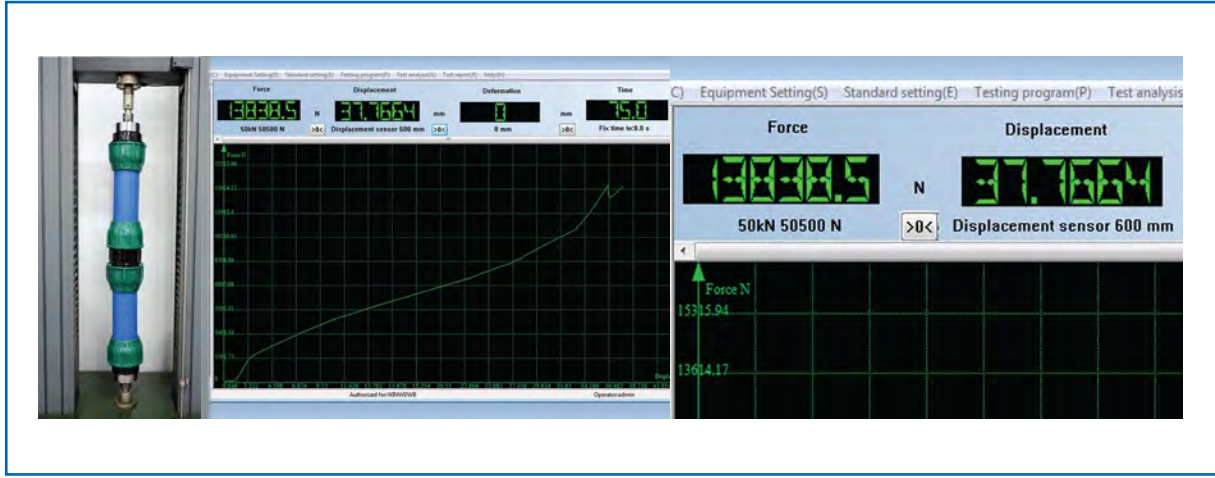

23 °C SICAKLIKTA AYRILMA DİRENCİ
PE boru ile montajlanmış ekleme parçaları, ISO 3501 test standardına göre test edilmektedir.

RESISTANCE TO PULL-OUT AT 23 °C
Compression fittings, assembled with PE pipes, are tested according to the ISO 3501 test standard.

PN 6 Grubu için 1 Saat Çekme Kuvveti (Newton) 1 Hour Pulling Force for PN 6 Group (Newton)

Ø20	Ø25	Ø32	Ø40	Ø50	Ø63	Ø75	Ø90	Ø110
1.119	1.623	2.123	2.362	2.984	4.701	6.499	9.411	13.813

İÇ BASINÇ ALTINDA SIZDIRMAZLIK
Montajlanmış ekleme parçaları, ISO 3458 test standardına göre test edilmektedir.

LEAKPROOFNESS UNDER INTERNAL PRESSURE
Assembled fittings are tested according to the ISO 3458 test standard.

TEST SICAKLIĞI / °C TEST TEMPERATURE	TEST SÜRESİ / SAAT TEST DURATION / HOUR	TEST BASINCI / BAR TEST PRESSURE PN 6
20 ± 5	1.0	9.0
20 ± 5	1.0	*24.0

*Özel Test / Special Test



BÜKÜLÜ İKEN İÇ BASINÇ ALTINDA SIZDIRMAZLIK
Ø 20-63 mm Montajlanmış ekleme parçaları, ISO 3503 test standardına göre test edilmektedir.

LEAKPROOFNESS UNDER INTERNAL PRESSURE WHEN SUBJECTED TO BENDING
Ø 20-63 mm Assembled fittings are tested according to the ISO 3503 test standard.

TEST SICAKLIĞI / °C TEST TEMPERATURE	TEST SÜRESİ / SAAT TEST DURATION / HOUR	TEST BASINCI / BAR TEST PRESSURE PN 6
23 ± 2	1.0	9.0

DİŞLER Ekleme parçaları için dişler, ISO 7-1 standardına uygundur.

THREADS Threads for compression fittings are covered by ISO 7-1 standard.

SU KALİTESİ ÜZERİNDEKİ ETKİSİ Ekleme parçaları, içme suyu üzerinde mikroorganizmaların çoğalmalarına izin vermemelidir. KIWA ve TSE kuruluşlarının laboratuvarları tarafından ilgili testler yapılarak raporlandırılmıştır.

INFLUENCE ON WATER QUALITY Compression fittings must not allow increasing microorganism on drinking water. It is reported with the related tests by the laboratories of KIWA and TSE Institutions.

MAVİ SERİ / YEŞİL SERİ

BLUE, GREEN SERIES COMPRESSION FITTINGS

СИНЯЯ СЕРИЯ / ЗЕЛЕНАЯ СЕРИЯ

سلسلة الخضراء / سلسلة الخضراء

DİKKAT EDİLMESİ GEREKEN HUSUSLAR

- + Poelsan boru bağlantı adaptörleri depolama ve montaj esnasında sert ve keskin cisimlerden uzak tutulmalıdır. Tesisat toprak altına döşenecekse, sert ve keskin cisimlerden korumak amacıyla kum ile kapatılmalıdır. Kesinlikle hasar görmüş adaptörler kullanılmamalıdır.
- + Poelsan boru bağlantı adaptörlerinden maksimum verim alabilmek için, te ve dirsekler 90°, diğer adaptörler 180° açı yapacak şekilde boruya monte edilmelidir. Değişik açılar oluşturan bağlantılar adaptör üzerinde gerilmelere neden olacağından tesisatın ömrü azalacaktır.
- + Dişli bağlantılarda teflon bant kullanılmalıdır. Teflon bant adaptöre su sızıntısını önleyecek kadar ve sıkma yönünde sarılmalıdır.
- + Montaj esnasında somunun fazla sıkılması adaptör üzerinde ek bir gerilmeye neden olur. Bu şekilde ek bir gerilmeye maruz kalmış olan ürünün garanti verilen basınç değerlerini karşılaması beklenemez. Bu nedenle ürünün plastik olduğu ve sadece sızdırmazlığı sağlayacak kuvvette sıkılması gerektiği unutulmamalıdır.

POINTS TO TAKE INTO CONSIDERATION

- + Poelsan compression fittings should be kept away from hard or sharp objects during storage or installation phases. If the installation will be under the ground, it should be covered with sand in order to keep away from contact with hard and sharp objects. Damaged fittings shouldn't be used strictly.
- + To be able to get the best efficiency from Poelsan compression fittings, tee and elbow pieces should be joined with 90°, other fittings should be joined with 180° to the system. The installation with different angles will make extra tensile on the fittings and will decrease the lifetime of the system.
- + Teflon band should be used with the threaded pieces. The band should be used enough to prevent water leakage and wrapped on the threaded part in the twisting direction.
- + Over twisting of the nut will cause extra tension on the adaptor. A nut, which is exposed to such an extra tension cannot provide the guaranteed pressure value. Therefore the user should remember that the material is plastic and the nut should be twisted with a force only enough to prevent leakage.

MAVİ SERİ / YEŞİL SERİ

BLUE, GREEN SERIES COMPRESSION FITTINGS

СИНЯЯ СЕРИЯ / ЗЕЛЕНАЯ СЕРИЯ

سلسلة الخضراء / سلسلة الخضراء

Tesisatın Son Kontrolü

GÖZLE KONTROL

Tesisatın döşenmesi sırasında hasar görmüş adaptörlerin tespiti için adaptörler mutlaka gözle kontrol edilmelidir.

SIZDIRMAZLIK KONTROLÜ

Tesisatın montajı sonrasında tesisata mutlaka test basıncında su verilmeli ve sızdırmazlık durumu tespit edilmelidir.

SIZINTIYA NEDEN OLABİLECEK UYGULAMALAR

Poelsan boru bağlantı adaptörlerinin dış ölçüleri standartlara uygun olarak üretilmiştir.

- Kullanılan diğer metal ya da plastik malzemenin uygun olmaması,
- Teflon bandın yeterli miktarda kullanılmaması,
- Ürünün aşırı miktarda sıkılması ya da montaj esnasında düzgün monte edilmemesi sonucu ürünün dışlarının bozulması,
- Montaj esnasında oringin zarar görmesi ya da oringin yerinden çıkması,
- Borulardaki ovalliğin verilen tolerans değerlerinden daha fazla olması,
- Somunun yanlış monte edilmesi, yeterli miktarda sıkılmaması ya da çok fazla sıkılarak ürünün çatlaması,
- Boru tutucunun oring tutucu ile birleştirilmeden somunun sıkılarak adaptörün montajının yapılması,

tesisatınızda sızıntıya neden olabilir.

Final Check of the Installation

VISUAL CHECK

During installation, the system should be checked visually in order to determine the damaged adaptors.

LEAKPROOFNESS CHECK

After the installation, the system should be checked with water in testing pressure to determine the water leak.

CONDITIONS THAT MAY CAUSE LEAKAGE

The measurements of the threads of Poelsan compression fittings are produced according to the standards.

- Unfitness of the measurements of the threads of other metal or plastic material,
- Unefficient use of the teflon band,
- Spoiling of the threads because of the improper installation or over twisting of the nut,
- Not chamfering the pipe during assembly causes the oring to be damaged, or dislocated,
- The ovality of pipes is more than the tolerance values,
- Wrong installation, inefficient twisting or cracking the nut by over twisting,
- Twisting the nut and installing the adaptor without joining the locking ring and the o-ring holder,

may cause leakage in the system.

YEŞİL SERİ ADAPTÖRLERİN MONTAJ YÖNTEMLERİ

GREEN SERIES INSTALLATION METHODS

1. MONTAJ YÖNTEMİ / INSTALLATION METHOD

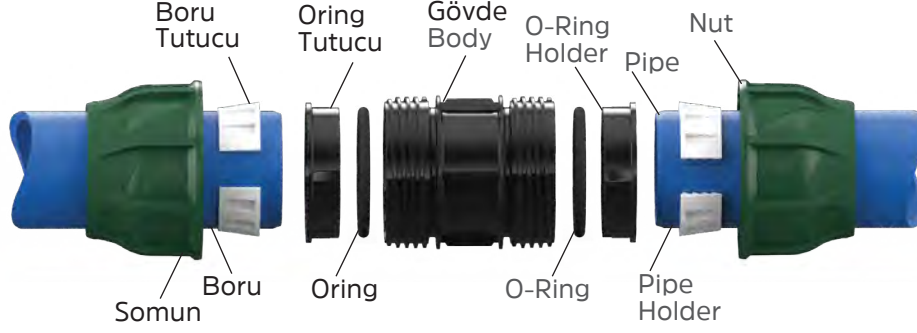

- 1 **Boru uçlarına yaklaşık 15° pah açınız.**
Make chamfer on the pipe ends. (Approximately 15°)



- 2 **Boru üzerini, borunun adaptöre geçiş mesafesine göre işaretleyiniz.**
Mark the pipe, according to the pipe end point inside the fitting.

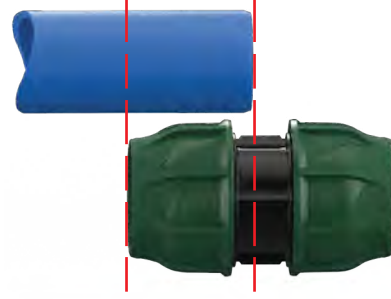

- 3 **Adaptörünüzün somununu yaklaşık 2 tam tur döndürüp gevşetiniz.**
Untwist 2 full rounds and loosen the nut of the fitting.



- 4 **Boruyu, adaptörünüzün iç kısmındaki * boru dayanma noktasına kadar iyice itiniz.**
Push the pipe to * the pipe end point inside the fitting.

- 5 **Somunu Poelsan Kablo Anahtarı ile sıkınız.**
Twist the nut with Poelsan Fitting Spanner.

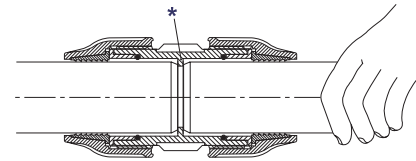

YEŞİL SERİ ADAPTÖRLERİN MONTAJ YÖNTEMLERİ

GREEN SERIES INSTALLATION METHODS

(Ø63, Ø75, Ø90, Ø110 mm adaptörler / adaptors)

(Standart dışı borularda ve montaj zorluğu yaşanan alanlarda tavsiye edilen yöntemdir.)

(It is the recommended method for non-standard pipes and areas where installation is difficult.)

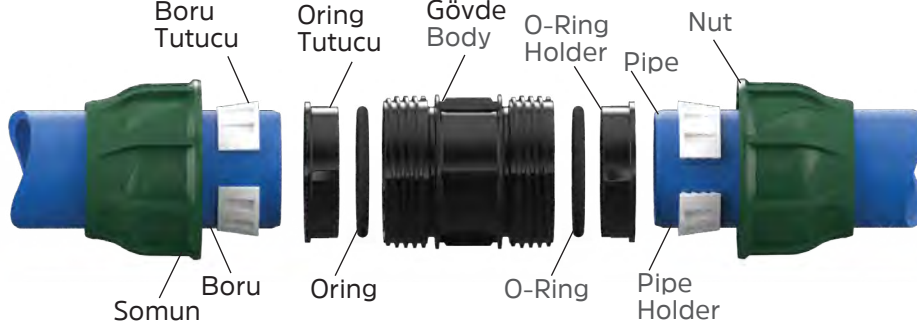

2. MONTAJ YÖNTEMİ / INSTALLATION METHOD

- 1** Pah açmaya gerek yoktur.
There is no need to make chamfer on the pipe end.

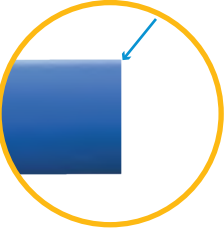

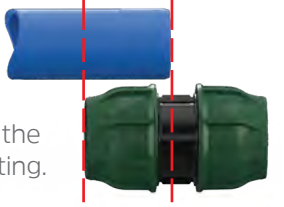
- 2** Boru üzerini, borunun adaptöre geçiş mesafesine göre işaretleyiniz.
Mark the pipe, according to the pipe end point inside the fitting.

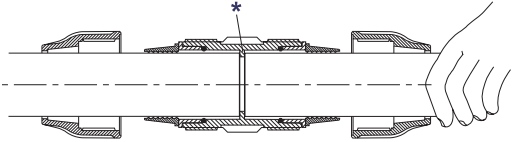

- 3** Boruya sırasıyla; önce somunu, sonra oring tutucu ve oringi takınız.
Place the nut, o-ring holder and the o-ring on the pipe respectively.



- 4** Boruyu, adaptörünüzün iç kısmındaki * boru dayanma noktasına kadar iyice itiniz.
Push the pipe to * the pipe end point inside the fitting.

- 5** Somunu sıkarak adaptörünüzle birleştiriniz. Bu işlem oring ve oring tutucunun kolayca takılmasını sağlayacaktır.
Twist the nut till it is attached to the fitting. This will help the o-ring and the o-ring holder to be placed easily.

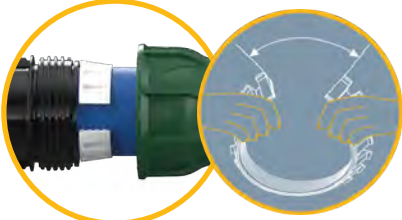
- 6** Somunu gevşeterek açınız.
Untwist and loosen the nut from the fitting.

- 7** Boru tutucuyu borunun çapı kadar esneterek boruya takınız. Boru üzerinde kaydırarak oring tutucu ile birleştiriniz.
Stretch the locking ring to the diameter of the pipe. Place it on the pipe by sliding it to the o-ring holder.

- 8** Somunu Poelsan Kablo Anahtarı ile sıkınız.
Twist the nut with Poelsan Fitting Spanner.



MAVİ SERİ ADAPTÖRLERİN MONTAJ YÖNTEMLERİ

BLUE SERIES INSTALLATION METHODS

(Ø20, Ø25, Ø32, Ø40, Ø50, mm adaptörler / adaptors)

I MONTAJ YÖNTEMİ / INSTALLATION METHOD

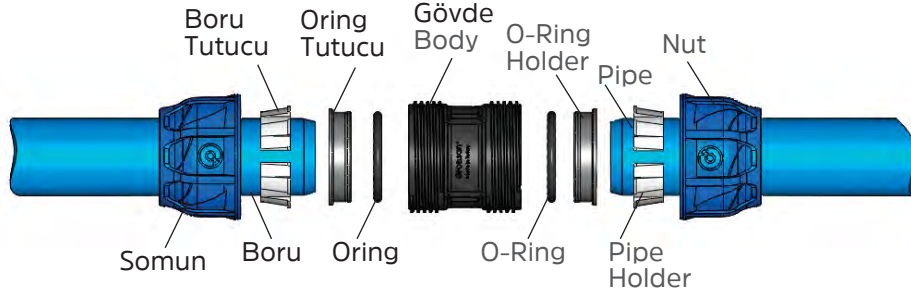

- 1** Boru uçlarına yaklaşık 15° pah açınız.
Make chamfer on the pipe ends. (Approximately 15°)



- 2** Boru üzerini, borunun adaptöre geçiş mesafesine göre işaretleyiniz.
Mark the pipe, according to the pipe end point inside the fitting.



- 3** Adaptörünüzün somununu yaklaşık 3 tam tur döndürüp gevşetiniz.
Untwist 3 full rounds and loosen the nut of the fitting.



- 4** Boruyu, adaptörünüzün iç kısmındaki * boru dayanma noktasına kadar iyice itiniz.
Push the pipe to * the pipe end point inside the fitting.

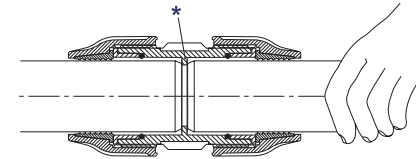

- 5** Somunu Poelsan Kablo Anahtarı ile sıkınız.
Twist the nut with Poelsan Fitting Spanner.



MAVİ SERİ ADAPTÖRLERİN MONTAJ YÖNTEMLERİ

BLUE SERIES INSTALLATION METHODS

(Ø63, Ø75, Ø90, Ø110, Ø125 mm adaptörler / adaptors)

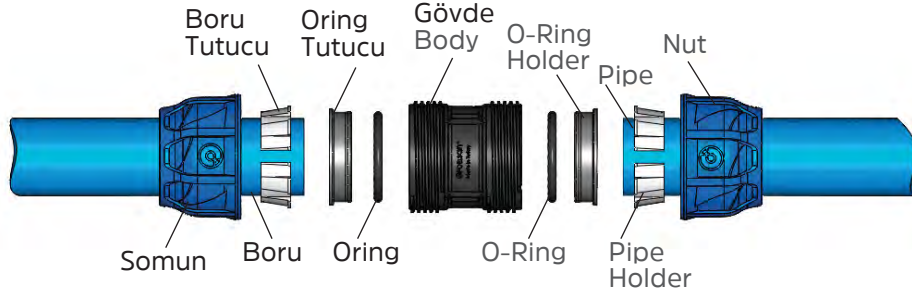

I MONTAJ YÖNTEMİ / INSTALLATION METHOD

1 Pah açmaya gerek yoktur.

There is no need to make chamfer on the pipe end.

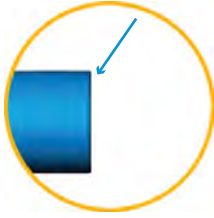

2

Boru üzerini, borunun adaptöre geçiş mesafesine göre işaretleyiniz.

Mark the pipe, according to the pipe end point inside the fitting.



3 Boruya sırasıyla; önce somunu, sonra oring tutucu ve oringi takınız.

Place the nut, o-ring holder and the o-ring on the pipe respectively.



4

Boruyu, adaptörünüzün iç kısmındaki * boru dayanma noktasına kadar iyice itiniz.

Push the pipe to * the pipe end point inside the fitting.

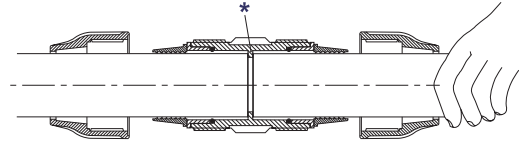

5

Somunu sıkarak adaptörünüzle birleştiriniz. Bu işlem oring ve oring tutucunun kolayca takılmasını sağlayacaktır.

Twist the nut till it is attached to the fitting. This will help the o-ring and the o-ring holder to be placed easily.



6

Somunu gevşeterek açınız.

Untwist and loosen the nut from the fitting.



7

Boru tutucuyu borunun çapı kadar esneterek boruya takınız. Boru üzerinde kaydırarak oring tutucu ile birleştiriniz.

Stretch the locking ring to the diameter of the pipe. Place it on the pipe by sliding it to the o-ring holder.

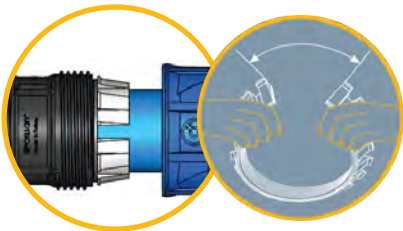

8

Somunu Poelsan Kablo Anahtarı ile sıkınız.

Twist the nut with Poelsan Fitting Spanner.



YEŞİL SERİ

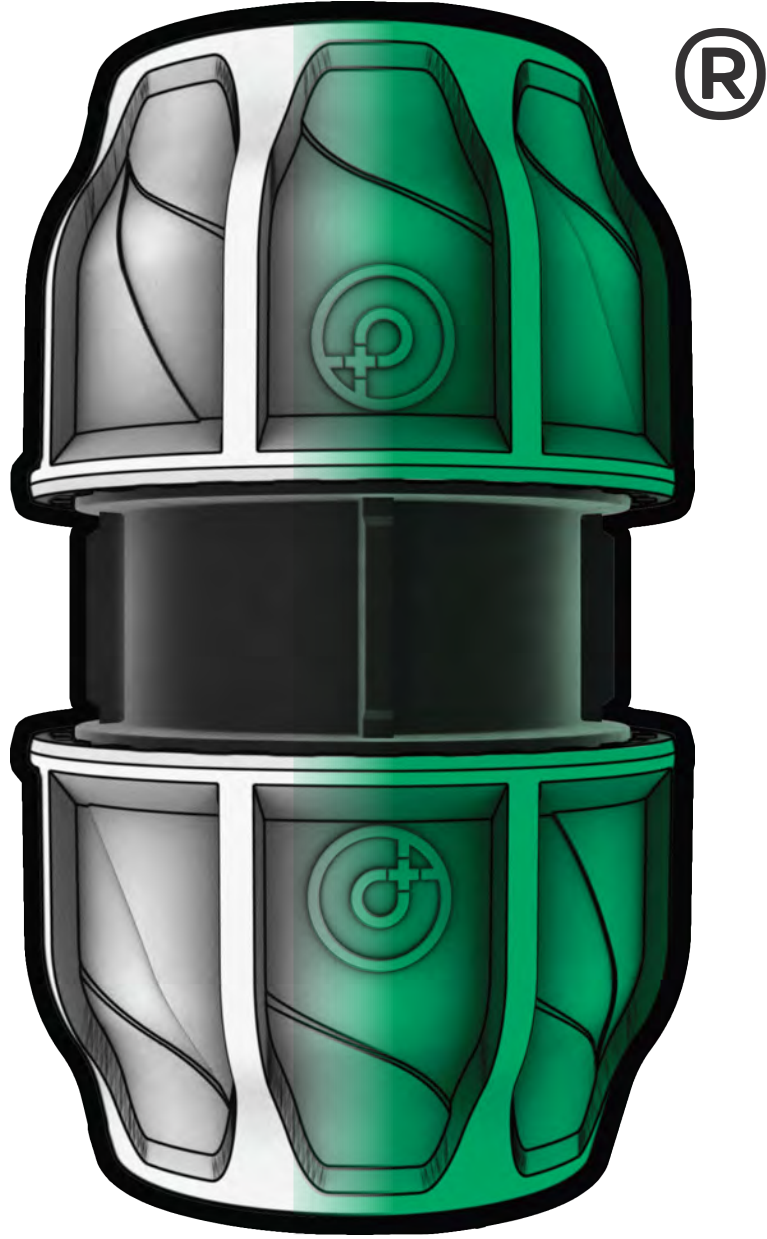

POELSAN®

GREEN SERIES

PRİZ KOLYE
CLAMP SADDLES
СЕДЛОВЫЕ ВРЕЗКИ
ربط السرجي

Özellikler

- + Darbelere karşı dayanıklı, yüksek kaliteli polipropilen hammaddeden üretilmiştir.
- + Borulardaki ölçü farklılıklarından doğabilecek sızıntıları önleyebilecek şekilde tasarlanmıştır.
- + Oringi kauçuktan üretilmekte olup yüksek basınç altında sızdırmazlık sağlar.
- + Ürünlerimizde kullanılan korozyona dayanıklı metal yüzük sayesinde 50 °C'yi aşmayan sistemlerde güvenle kullanılabilir.
- + Suyun kokusunu ve tadını değiştirebilecek zararlı bileşikler içermez.
- + İçme suyunda kullanıma uygundur.
- + Metal yüzük, cıvata, somun ve pullar paslanmaz çelik ve galvaniz olarak çeşitlendirilmiştir.
- + Somunlar, alt kapaktaki yuvalarına yerleştirildiği için hızlı ve kolay montaj yapılmasını sağlar.
- + Diş ölçüleri ISO 7-1 Standardına uygundur.
- + ISO 13460-1 Standardına uygundur.

KULLANIM ALANLARI

- + Şehir Şebekesi İçme Suyu
- + Peyzaj Sektörü
- + Tarımsal Sulama
- + Seralar

INSTALLATION AREAS

- + Urban Potable Water Networks
- + Landscaping Systems
- + Agricultural Irrigation
- + Greenhouses

GARANTİ VERİLEN BASINÇ DEĞERLERİ

GUARANTEED PRESSURE VALUES

Ø 25 mm – Ø 110 mm	: PN 16
2"	: PN 10
Ø 125 mm – Ø 225 mm	: PN 10
3" – 4"	: PN 6

Specifications

- + It has been produced from high quality polypropylene raw material and it has resistance to impact.
- + It is designed to prevent leakage caused by the size differences of the pipes.
- + O-rings are made of rubber and provide leakproofness under high pressure.
- + Thanks to the corrosion resistant metal ring used in our products, it can be used safely in systems not exceeding 50 °C.
- + It does not contain any harmful compounds which can change the taste or the smell of the water.
- + It is suitable to be used for drinking water.
- + Reinforcing ring, bolt, nut and washers are varied as stainless steel and galvanized.
- + Because the nuts are inserted in their housing on the lower part, it provides quick and easy installation.
- + Thread sizes are compatible with ISO 7-1 Standard.
- + It is compatible with ISO 13460-1 Standard.



TS ISO 13460-1



PRİZ KOLYE /CLAMP SADDLES

ربط السرجي / СЕДЛОВЫЕ ВРЕЗКИ



PRİZ KOLYE GALVANİZ CIVATALI & METAL YÜZÜKLÜ

CLAMP SADDLE
WITH GALVANIZED
BOLT & REINFORCING RING

СЕДЛОВАЯ ВРЕЗКА
С УСИЛИВАЮЩИМ
КОЛЬЦОМ

ربط السرجي مع البراغي
الكلفنايز و الحلقة المدعمة

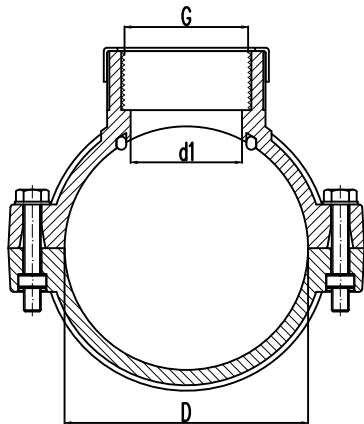

KOD CODE	EBAT / SIZE D x G	CIVATA ADEDİ BOLT QUANTITY	AMBALAJ ADEDİ PACKING QUANTITY	KOLİ ADEDİ BOX QUANTITY	ÇUVAL ADEDİ SACK QUANTITY
100120201	25 x 1/2"	2	25	300	350
100120301	32 x 1/2"	2	25	250	300
100120302	32 x 3/4"	2	25	250	275
100120401	40 x 1/2"	2	25	200	200
100120402	40 x 3/4"	2	25	175	200
100120501	50 x 1/2"	2	10	160	180
100120502	50 x 3/4"	2	10	150	180
100120503	50 x 1"	2	10	130	150
100120601	63 x 1/2"	4	10	110	120
100120602	63 x 3/4"	4	10	110	120
100120603	63 x 1"	4	10	100	110
100120604	63 x 1 1/4"	4	10	80	90
100120605	63 x 1 1/2"	4	10	80	90
100120701	75 x 1/2"	4	5	90	110
100120702	75 x 3/4"	4	5	90	110
100120703	75 x 1"	4	5	80	90
100120704	75 x 1 1/4"	4	5	55	60
100120705	75 x 1 1/2"	4	5	55	70
100120706	75 x 2"	4	5	50	60
100120801	90 x 1/2"	4	5	75	85
100120802	90 x 3/4"	4	5	70	80
100120803	90 x 1"	4	5	60	70
100120804	90 x 1 1/4"	4	5	40	50
100120805	90 x 1 1/2"	4	5	40	50
100120806	90 x 2"	4	5	40	50
100120901	110 x 1/2"	4	5	55	65
100120902	110 x 3/4"	4	5	55	65
100120903	110 x 1"	4	5	50	60
100120904	110 x 1 1/4"	4	5	35	40
100120905	110 x 1 1/2"	4	5	35	45
100120906	110 x 2"	4	5	30	35
100121001	125 x 1/2"	4	2	44	40
100121002	125 x 3/4"	4	2	44	40
100121003	125 x 1"	4	2	40	40
100121004	125 x 1 1/4"	4	2	40	40
100121005	125 x 1 1/2"	4	2	42	40
100121006	125 x 2"	4	2	42	40
100121101	140 x 1/2"	6	2	36	36

Lütfen ürünlerin ambalaj bilgisi için bkz: Sayfa 158

KOD CODE	EBAT / SIZE D x G	CIVATA ADEDİ BOLT QUANTITY	AMBALAJ ADEDİ PACKING QUANTITY	KOLİ ADEDİ BOX QUANTITY	ÇUVAL ADEDİ SACK QUANTITY
100121102	140 x ¾"	6	2	36	36
100121103	140 x 1"	6	2	36	36
100121104	140 x 1¼"	6	2	36	36
100121105	140 x 1½"	6	2	40	32
100121106	140 x 2"	6	2	40	32
100121201	160 x ½"	6	2	26	24
100121202	160 x ¾"	6	2	26	24
100121203	160 x 1"	6	2	26	24
100121204	160 x 1¼"	6	2	24	24
100121205	160 x 1½"	6	2	24	24
100121206	160 x 2"	6	2	22	24
100121207	160 x 2½"	6	2	16	14
100121208	160 x 3"	6	2	12	12
100121209	160 x 4"	6	2	12	12
100121302	180 x ¾"	6	2	10	14
100121303	180 x 1"	6	2	10	14
100121304	180 x 1¼"	6	2	10	14
100121305	180 x 1½"	6	2	10	14
100121306	180 x 2"	6	2	10	14
100121307	180 x 2½"	6	2	10	12
100121308	180 x 3"	6	2	10	12
100121309	180 x 4"	6	2	8	10
100121402	200 x ¾"	6	2	10	12
100121403	200 x 1"	6	2	10	12
100121404	200 x 1¼"	6	2	10	12
100121405	200 x 1½"	6	2	10	12
100121406	200 x 2"	6	2	8	8
100121407	200 x 2½"	6	2	8	8
100121408	200 x 3"	6	2	8	8
100121409	200 x 4"	6	2	8	8
100121503	225 x 1"	6	2	8	8
100121504	225 x 1¼"	6	2	8	8
100121505	225 x 1½"	6	2	8	8
100121506	225 x 2"	6	2	8	8
100121507	225 x 2½"	6	2	8	8
100121508	225 x 3"	6	2	8	8
100121509	225 x 4"	6	2	8	8



PRİZ KOLYE GALVANİZ CIVATALI & METAL YÜZÜKLÜ

CLAMP SADDLE
WITH GALVANIZED
BOLT & REINFORCING RING

СЕДЛОВАЯ ВРЕЗКА
С УСИЛИВАЮЩИМ
КОЛЬЦОМ

ربط السرجي مع البراغي
الكفنايز و الحلقة المدعمة

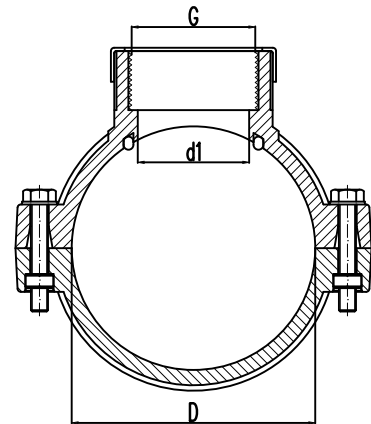

ربط السرجي / СЕДЛОВАЯ ВРЕЗКА

PRİZ KOLYE / CLAMP SADDLES

ربط السرجي / СЕДЛОВЫЕ ВРЕЗКИ



PRİZ KOLYE ÇİFT ÇIKIŞLI GALVANİZ CIVATALI & METAL YÜZÜKLÜ

DOUBLE ENDED CLAMP SADDLE
WITH GALVANIZED
BOLT & REINFORCING RING

ДВУХСТОРОННЯЯ
СЕДЛОВАЯ ВРЕЗКА С
УСИЛИВАЮЩИМ КОЛЬЦОМ

ربط السرجي مع البراغي

الكلفنايز و الحلقة المدعمة المزدوجة

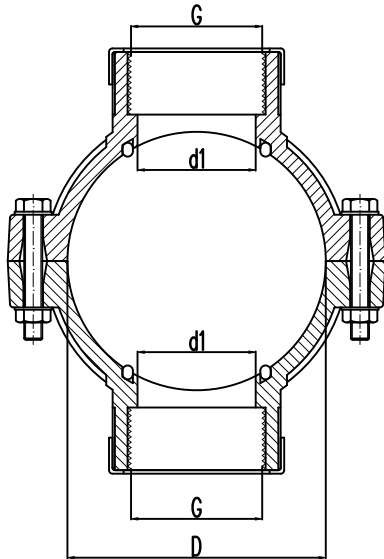

KOD CODE	EBAT / SIZE D x G	CIVATA ADEDİ BOLT QUANTITY	AMBALAJ ADEDİ PACKING QUANTITY	KOLİ ADEDİ BOX QUANTITY	ÇUVAL ADEDİ SACK QUANTITY
100140201	25 x 1/2" x 1/2"	2	25	250	275
100140301	32 x 1/2" x 1/2"	2	25	200	250
100140302	32 x 3/4" x 3/4"	2	25	200	250
100140401	40 x 1/2" x 1/2"	2	25	150	180
100140402	40 x 3/4" x 3/4"	2	25	150	180
100140501	50 x 1/2" x 1/2"	2	10	140	170
100140502	50 x 3/4" x 3/4"	2	10	120	160
100140503	50 x 1" x 1"	2	10	120	130
100140601	63 x 1/2" x 1/2"	4	10	90	110
100140602	63 x 3/4" x 3/4"	4	10	90	100
100140603	63 x 1" x 1"	4	10	80	90
100140604	63 x 1 1/4" x 1 1/4"	4	10	50	60
100140605	63 x 1 1/2" x 1 1/2"	4	10	50	60
100140701	75 x 1/2" x 1/2"	4	5	80	90
100140702	75 x 3/4" x 3/4"	4	5	80	90
100140703	75 x 1" x 1"	4	5	70	80
100140704	75 x 1 1/4" x 1 1/4"	4	5	40	45
100140705	75 x 1 1/2" x 1 1/2"	4	5	40	45
100140706	75 x 2" x 2"	4	5	40	45
100140801	90 x 1/2" x 1/2"	4	5	60	80
100140802	90 x 3/4" x 3/4"	4	5	60	80
100140803	90 x 1" x 1"	4	5	50	60
100140804	90 x 1 1/4" x 1 1/4"	4	5	35	40
100140805	90 x 1 1/2" x 1 1/2"	4	5	35	40
100140806	90 x 2" x 2"	4	5	30	40
100140901	110 x 1/2" x 1/2"	4	5	50	65
100140902	110 x 3/4" x 3/4"	4	5	50	65
100140903	110 x 1" x 1"	4	5	40	50
100140904	110 x 1 1/4" x 1 1/4"	4	5	30	35
100140905	110 x 1 1/2" x 1 1/2"	4	5	30	35
100140906	110 x 2" x 2"	4	5	30	35
100141001	125 x 1/2" x 1/2"	4	2	50	48
100141002	125 x 3/4" x 3/4"	4	2	48	48
100141003	125 x 1" x 1"	4	2	42	40
100141004	125 x 1 1/4" x 1 1/4"	4	2	42	40
100141005	125 x 1 1/2" x 1 1/2"	4	2	36	40
100141006	125 x 2" x 2"	4	2	34	34
100141101	140 x 1/2" x 1/2"	6	2	36	36

Lütfen ürünlerin ambalaj bilgisi için bkz: Sayfa 158



POELSAN

42

ÜRÜN KATALOĞU | PRODUCTION CATALOGUE

KOD CODE	EBAT / SIZE D x G	CIVATA ADEDİ BOLT QUANTITY	AMBALAJ ADEDİ PACKING QUANTITY	KOLİ ADEDİ BOX QUANTITY	ÇUVAL ADEDİ SACK QUANTITY
100141102	140 x ¾" x ¾"	6	2	34	36
100141103	140 x 1" x 1"	6	2	28	34
100141104	140 x 1¼" x 1¼"	6	2	26	28
100141105	140 x 1½" x 1½"	6	2	22	28
100141106	140 x 2" x 2"	6	2	22	28
100141201	160 x ½" x ½"	6	2	26	28
100141202	160 x ¾" x ¾"	6	2	26	28
100141203	160 x 1" x 1"	6	2	24	28
100141204	160 x 1¼" x 1¼"	6	2	22	24
100141205	160 x 1½" x 1½"	6	2	20	24
100141206	160 x 2" x 2"	6	2	20	24
100141207	160 x 2½" x 2½"	6	2	12	14
100141208	160 x 3" x 3"	6	2	12	12
100141209	160 x 4" x 4"	6	2	10	10
100141302	180 x ¾" x ¾"	6	2	10	14
100141303	180 x 1" x 1"	6	2	10	14
100141304	180 x 1¼" x 1¼"	6	2	10	14
100141305	180 x 1½" x 1½"	6	2	10	14
100141306	180 x 2" x 2"	6	2	10	14
100141307	180 x 2½" x 2½"	6	2	8	10
100141308	180 x 3" x 3"	6	2	8	10
100141309	180 x 4" x 4"	6	2	6	8
100141402	200 x ¾" x ¾"	6	2	10	12
100141403	200 x 1" x 1"	6	2	10	12
100141404	200 x 1¼" x 1¼"	6	2	10	10
100141405	200 x 1½" x 1½"	6	2	8	10
100141406	200 x 2" x 2"	6	2	8	10
100141407	200 x 2½" x 2½"	6	2	8	10
100141408	200 x 3" x 3"	6	2	8	8
100141409	200 x 4" x 4"	6	2	6	8
100141503	225 x 1" x 1"	6	2	8	8
100141504	225 x 1¼" x 1¼"	6	2	8	8
100141505	225 x 1½" x 1½"	6	2	8	8
100141506	225 x 2" x 2"	6	2	8	8
100141507	225 x 2½" x 2½"	6	2	8	8
100141508	225 x 3" x 3"	6	2	8	8
100141509	225 x 4" x 4"	6	2	4	8



ربط السرجي /
СЕДЛОВЫЕ ВРЕЗКИ

PRİZ KOLYE ÇİFT ÇIKIŞLI GALVANİZ CIVATALI & METAL YÜZÜKLÜ

DOUBLE ENDED CLAMP SADDLE
WITH GALVANIZED
BOLT & REINFORCING RING

ДВУХСТОРОННЯЯ
СЕДЛОВАЯ ВРЕЗКА С
УСИЛИВАЮЩИМ КОЛЬЦОМ

ربط السرجي مع البراغي
الكفنايز و الحلقة المدعمة المزدوجة

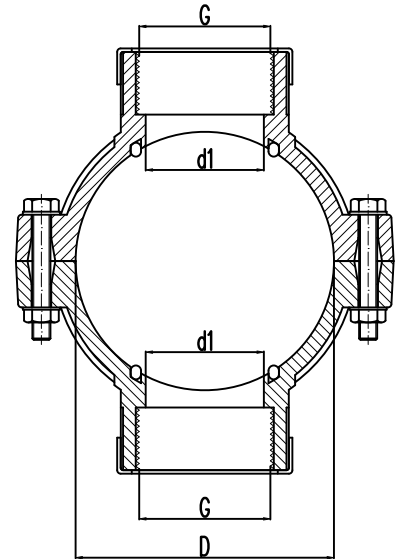

Lütfen ürünlerin ambalaj bilgisi için bkz: Sayfa 158



**PRİZ KOLYE
PASLANMAZ CIVATALI
(AISI304)
PASLANMAZ METAL YÜZÜKLÜ
(AISI430)**

CLAMP SADDLE
WITH STAINLESS STEEL BOLT
(AISI304)
STAINLESS STEEL REINFORCING RING
(AISI430)

СЕДЛОВАЯ ВРЕЗКА
С УСИЛИВАЮЩИМ
КОЛЬЦОМ ИЗ
НЕРЖАВЕЮЩЕЙ СТАЛИ
ربط السرجي مع البراغي
الفولاذ و الحلقة المدعمة

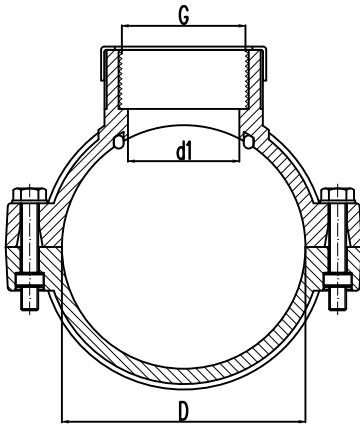

KOD CODE	EBAT / SIZE D x G	CIVATA ADEDİ BOLT QUANTITY	AMBALAJ ADEDİ PACKING QUANTITY	KOLİ ADEDİ BOX QUANTITY	ÇUVAL ADEDİ SACK QUANTITY
100160201	25 x ½"	2	25	300	350
100160301	32 x ½"	2	25	250	300
100160302	32 x ¾"	2	25	250	275
100160401	40 x ½"	2	25	200	200
100160402	40 x ¾"	2	25	175	200
100160501	50 x ½"	2	10	160	180
100160502	50 x ¾"	2	10	150	180
100160503	50 x 1"	2	10	130	150
100160601	63 x ½"	4	10	110	120
100160602	63 x ¾"	4	10	110	120
100160603	63 x 1"	4	10	100	110
100160604	63 x 1¼"	4	10	80	90
100160605	63 x 1½"	4	10	80	90
100160701	75 x ½"	4	5	90	110
100160702	75 x ¾"	4	5	90	110
100160703	75 x 1"	4	5	80	90
100160704	75 x 1¼"	4	5	55	60
100160705	75 x 1½"	4	5	50	60
100160706	75 x 2"	4	5	50	60
100160801	90 x ½"	4	5	75	85
100160802	90 x ¾"	4	5	70	80
100160803	90 x 1"	4	5	60	70
100160804	90 x 1¼"	4	5	40	50
100160805	90 x 1½"	4	5	40	50
100160806	90 x 2"	4	5	40	50
100160901	110 x ½"	4	5	55	65
100160902	110 x ¾"	4	5	55	65
100160903	110 x 1"	4	5	50	60
100160904	110 x 1¼"	4	5	35	40
100160905	110 x 1½"	4	5	35	45
100160906	110 x 2"	4	5	30	35
100161001	125 x ½"	4	2	44	40
100161002	125 x ¾"	4	2	44	40
100161003	125 x 1"	4	2	40	40
100161004	125 x 1¼"	4	2	40	40
100161005	125 x 1½"	4	2	40	40
100161006	125 x 2"	4	2	40	40
100161101	140 x ½"	6	2	36	36

Lütfen ürünlerin ambalaj bilgisi için bkz: Sayfa 158



**PRİZ KOLYE ÇİFT ÇIKIŞLI
PASLANMAZ CIVATALI
(AISI304)
PASLANMAZ METAL YÜZÜKLÜ
(AISI430)**

DOUBLE ENDED CLAMP SADDLE
WITH STAINLESS STEEL BOLT
(AISI304)
STAINLESS STEEL
REINFORCING RING
(AISI430)

ДВУХСТОРОННЯЯ СЕДЛОВАЯ
ВРЕЗКА С УСИЛИВАЮЩИМ КОЛЬЦОМ
ИЗ НЕРЖАВЕЮЩЕЙ СТАЛИ
ربط السرجي مع البراغي الفولاذ و
الحلقة المدعمة المزودة

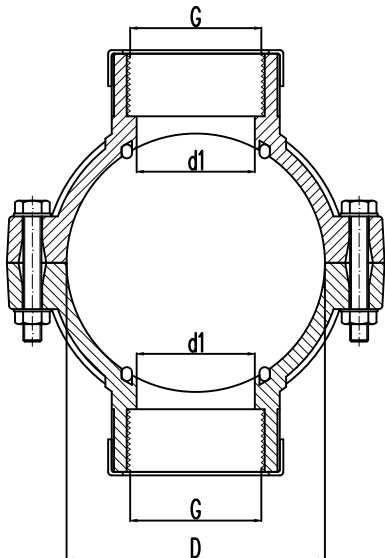

KOD CODE	EBAT / SIZE D x G	CIVATA ADEDİ BOLT QUANTITY	AMBALAJ ADEDİ PACKING QUANTITY	KOLİ ADEDİ BOX QUANTITY	ÇİVAL ADEDİ SACK QUANTITY
100180201	25 x 1/2" x 1/2"	2	25	250	275
100180301	32 x 1/2" x 1/2"	2	25	200	250
100180302	32 x 3/4" x 3/4"	2	25	200	250
100180401	40 x 1/2" x 1/2"	2	25	150	180
100180402	40 x 3/4" x 3/4"	2	25	150	180
100180501	50 x 1/2" x 1/2"	2	10	140	170
100180502	50 x 3/4" x 3/4"	2	10	120	160
100180503	50 x 1" x 1"	2	10	120	130
100180601	63 x 1/2" x 1/2"	4	10	90	110
100180602	63 x 3/4" x 3/4"	4	10	90	100
100180603	63 x 1" x 1"	4	10	80	90
100180604	63 x 1 1/4" x 1 1/4"	4	10	50	60
100180605	63 x 1 1/2" x 1 1/2"	4	10	50	60
100180701	75 x 1/2" x 1/2"	4	5	80	90
100180702	75 x 3/4" x 3/4"	4	5	80	90
100180703	75 x 1" x 1"	4	5	70	80
100180704	75 x 1 1/4" x 1 1/4"	4	5	40	45
100180705	75 x 1 1/2" x 1 1/2"	4	5	40	45
100180706	75 x 2" x 2"	4	5	40	45
100180801	90 x 1/2" x 1/2"	4	5	60	80
100180802	90 x 3/4" x 3/4"	4	5	60	80
100180803	90 x 1" x 1"	4	5	50	60
100180804	90 x 1 1/4" x 1 1/4"	4	5	35	40
100180805	90 x 1 1/2" x 1 1/2"	4	5	35	40
100180806	90 x 2" x 2"	4	5	50	65
100180901	110 x 1/2" x 1/2"	4	5	50	65
100180902	110 x 3/4" x 3/4"	4	5	40	50
100180903	110 x 1" x 1"	4	5	30	35
100180904	110 x 1 1/4" x 1 1/4"	4	5	35	40
100180905	110 x 1 1/2" x 1 1/2"	4	5	30	35
100180906	110 x 2" x 2"	4	5	30	35
100181001	125 x 1/2" x 1/2"	4	2	50	48
100181002	125 x 3/4" x 3/4"	4	2	48	48
100181003	125 x 1" x 1"	4	2	42	40
100181004	125 x 1 1/4" x 1 1/4"	4	2	42	40
100181005	125 x 1 1/2" x 1 1/2"	4	2	36	40
100181006	125 x 2" x 2"	4	2	34	34
100181101	140 x 1/2" x 1/2"	6	2	36	36

Lütfen ürünlerin ambalaj bilgisi için bkz: Sayfa 158

KOD CODE	EBAT / SIZE D x G	CIVATA ADEDİ BOLT QUANTITY	AMBALAJ ADEDİ PACKING QUANTITY	KOLİ ADEDİ BOX QUANTITY	ÇUVAL ADEDİ SACK QUANTITY
100181102	140 x ¾" x ¾"	6	2	34	36
100181103	140 x 1" x 1"	6	2	28	34
100181104	140 x 1¼" x 1¼"	6	2	26	28
100181105	140 x 1½" x 1½"	6	2	22	28
100181106	140 x 2" x 2"	6	2	22	28
100181201	160 x ½" x ½"	6	2	26	26
100181202	160 x ¾" x ¾"	6	2	26	28
100181203	160 x 1" x 1"	6	2	24	28
100181204	160 x 1¼" x 1¼"	6	2	22	24
100181205	160 x 1½" x 1½"	6	2	20	24
100181206	160 x 2" x 2"	6	2	20	24
100181207	160 x 2½" x 2½"	6	2	12	14
100181208	160 x 3" x 3"	6	2	12	12
100181209	160 x 4" x 4"	6	2	10	10
100181302	180 x ¾" x ¾"	6	2	10	14
100181303	180 x 1" x 1"	6	2	10	14
100181304	180 x 1¼" x 1¼"	6	2	10	14
100181305	180 x 1½" x 1½"	6	2	10	14
100181306	180 x 2" x 2"	6	2	10	14
100181307	180 x 2½" x 2½"	6	2	8	10
100181308	180 x 3" x 3"	6	2	8	10
100181309	180 x 4" x 4"	6	2	6	8
100181402	200 x ¾" x ¾"	6	2	10	12
100181403	200 x 1" x 1"	6	2	10	12
100181404	200 x 1¼" x 1¼"	6	2	10	10
100181405	200 x 1½" x 1½"	6	2	8	10
100181406	200 x 2" x 2"	6	2	8	10
100181407	200 x 2½" x 2½"	6	2	8	10
100181408	200 x 3" x 3"	6	2	8	8
100181409	200 x 4" x 4"	6	2	6	8
100181503	225 x 1" x 1"	6	2	8	8
100181504	225 x 1¼" x 1¼"	6	2	8	8
100181505	225 x 1½" x 1½"	6	2	8	8
100181506	225 x 2" x 2"	6	2	8	8
100181507	225 x 2½" x 2½"	6	2	8	8
100181508	225 x 3" x 3"	6	2	8	8
100181509	225 x 4" x 4"	6	2	4	8

KOD CODE	EBAT / SIZE	AMBALAJ ADEDİ PACKING QUANTITY
16080	10 mm	5
16083	13 mm	5



**PRİZ KOLYE ÇİFT ÇIKIŞLI
PASLANMAZ CIVATALI
(AISI304)
PASLANMAZ METAL YÜZÜKLÜ
(AISI430)**

DOUBLE ENDED CLAMP SADDLE
WITH STAINLESS STEEL BOLT
(AISI304)

STAINLESS STEEL
REINFORCING RING
(AISI430)

ДВУХСТОРОННЯЯ СЕДЛОВАЯ
ВРЕЗКА С УСИЛИВАЮЩИМ КОЛЬЦОМ
ИЗ НЕРЖАВЕЮЩЕЙ СТАЛИ

ربط السرجي مع البراغي الفولاذ و
الحلقة المدعمة المزدوجة

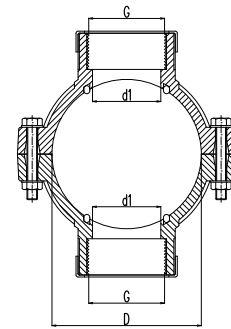

MANYETİK LOKMA UÇ

MAGNETIC SOCKET WRENCH
МАГНИТНЫЙ ТОРЦЕВОЙ КЛЮЧ

مفتاح البراغي المغناطيسية

Lütfen ürünlerin ambalaj bilgisi için bkz: Sayfa 158

PRİZ KOLYELERİN MONTAJ TALİMATI

INSTALLATION INSTRUCTIONS FOR CLAMP SADDLES

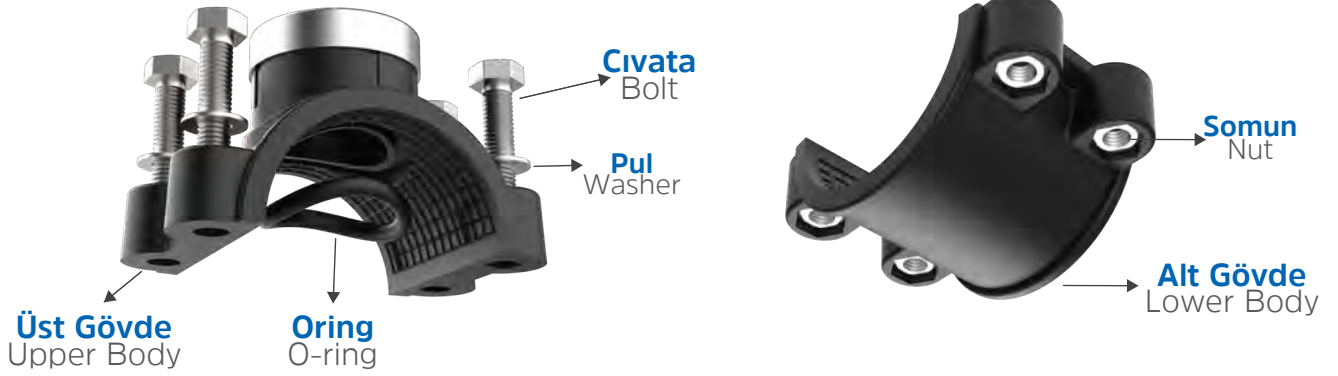

- 1** Borunun çıkış alacağınız noktayı işaretleyiniz.

Mark the point from where you will take off the pipe.



- 2** Priz kolye oringini, üst kapak üzerinde bulunan oring yuvasına düzgün şekilde yerleştiriniz.

Place the O-ring properly into the socket on the upper body.



- 3** Boru üzerinde önce somunları monte edilmiş alt kapağı, sonra üst kapağını boru üzerinde işaretlediğiniz noktaya göre boruya takınız.

First, mount the lower part to the pipe which nuts are inserted on it, then mount the upper part according to the point you marked before on the pipe.



PRİZ KOLYELERİN MONTAJ TALİMATI

INSTALLATION INSTRUCTIONS FOR CLAMP SADDLES

- 4 Cıvata ve pulu, manyetik lokma ucuna takınız. Priz kolyelerin çapına uygun tork değerlerine göre matkabınızı ayarlayınız.

Mount the bolt and the washer into the tip of magnetic socket wrench. Adjust the drill according to the appropriate torque values for clamp saddles dimension.

EBAT / SIZE mm	TORK DEĞERLERİ TORQUE VALUES (nm)
Ø25 - Ø32 - Ø40 - Ø50	4,5 Nm
Ø63 - Ø75 - Ø90 - Ø110	6,3 Nm
Ø125 - Ø140	12 Nm
Ø160 - Ø180	13 Nm
Ø200 - Ø225	14 Nm

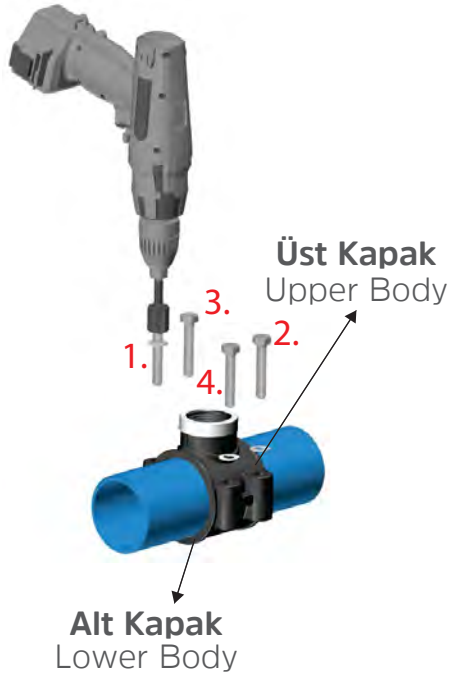
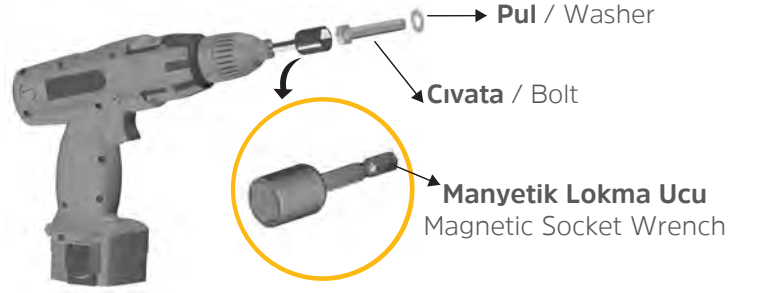

- 5 1. Cıvata ve pulu üst kapak üzerindeki yuvalarına yerleştirerek yarım sıkınız. Sırasıyla, 2. 3. ve 4. cıvataları ve pulları tam sıkınız. Son olarak yarım sıkılan 1. cıvata ve pulu tam sıkınız.

Place the 1st bolt and washer in their housing on the upper part and screw it halfway. Screw completely the 2nd, 3rd and 4th bolts and washers in sequence. Finally completely screw the 1st bolt and washer which are half screwed at the beginning.



- 6 Diş ölçüsüne uygun bir matkap ucu ile ek parçaya değmeyecek şekilde boru delme işlemini gerçekleştiriniz.

Carry out the pipe drilling without touching the saddles with an appropriate drill bit for the thread dimension.

PRİZ KOLYE

CLAMP SADDLES

СЕДЛОВЫЕ ВРЕЗКИ

ربط السرجي

DİKKAT EDİLMESİ GEREKEN HUSUSLAR

- + Priz Kolyeler depolama ve montaj esnasında sert ve keskin cisimlerden uzak tutulmalıdır. Tesisat toprak altına döşenecekse, sert ve keskin cisimlerden korumak amacıyla kum ile kapatılmalıdır. Hasar görmüş ürünler kesinlikle kullanılmamalıdır.
- + Priz kolyelerde oring, yuvasına düzgünce yerleştirilmeli ve montaj esnasında yerinden çıkmasına özen gösterilmelidir.
- + Priz kolye ile kullanılacak erkek adaptörlere teflon bant sızdırmazlığı sağlayacak kadar ve sıkma yönüyle aynı yönde sarılmalıdır.
- + Priz kolyelerin montajından sonra yapılan boru delme işlemi, uygun bir matkap ucu ile dişlere değmeyecek şekilde gerçekleştirilmelidir.
- + Boruda standart değerinden daha büyük bir ölçüde ise priz kolye montajında alt ve üst kapaklar birbirine değmeyecektir. Bu durumda; cıvatalı priz kolyelerin cıvatalarının alt ve üst kapaklar birbirine değene kadar sıkılmasına gerek yoktur.
- + Priz kolyelerin montajı sırasında cıvata ve somunlar karşılıklı olarak dengeli sıkılmalıdır.

POINTS TO TAKE INTO CONSIDERATION

- + Clamp saddles should be kept away from hard and sharp objects during the storage and installation. If the installation is laid under the ground, it should be covered with sand to protect it from hard and sharp objects. Any damaged adaptor should not be used absolutely.
- + The o-ring should be placed in its socket properly in order not to be unsettled during the installation.
- + Male adaptors to be used with Clamp Saddles, should be wrapped up with the teflon band with the tightening direction and should be wrapped enough to prevent leakage.
- + Drilling the pipe after the installation of Clamp Saddles can cause the damage of the threads. Thus, drilling must be carried out in a way that it does not touch the threads with a suitable drill bit.
- + If the dimension of the installed pipes is bigger than the standard values upper and lower parts will not contact each other. Under these circumstances, there is no need to tighten the bolts till the upper and lower body parts contact or hammer the slides to the end point.
- + Bolts and nuts must be tightened mutually balanced during installation of the Clamp Saddles.

PRİZ KOLYE

CLAMP SADDLES
СЕДЛОВЫЕ ВРЕЗКИ
ربط السرجي

Tesisatın Son Kontrolü

GÖZLE KONTROL

Tesisatın kurulumu sırasında kullanılan ürünlerin hasar tespiti için mutlaka gözle kontrol yapılmalıdır.

SIZDIRMAZLIK KONTROLÜ

Tesisatın kurulumu sonrasında sisteme mutlaka test basıncında su verilmeli ve sızdırmazlık durumu tespit edilmelidir.

SIZINTIYA NEDEN OLABİLECEK UYGULAMALAR

- Boru ölçülerinin uluslararası standartlara uygun olmaması,
- Kullanılan diğer metal ya da plastik malzemenin uluslararası standartlara uygun olmaması,
- Teflon bandın yeterli miktarda ve uygun şekilde kullanılmaması,
- Montaj sırasında Priz Kolyenin talimatlara uygun monte edilmemesi,
- Matkap ile boru delme esnasında Priz kolyenin dişlerine zarar verilmesi,
- Montaj esnasında oringin zarar görmesi ya da oringin yerinden çıkması,

tesisatınızda sızıntıya neden olabilir.

Final Check of the Installation

VISUAL CHECK

During installation, the system should be checked visually in order to determine the damaged clamp saddles.

LEAKPROOFNESS CHECK

After the installation, the system should be checked with water in testing pressure to determine the water leak.

CONDITIONS THAT MAY CAUSE LEAKAGE

- Pipe sizes do not comply with international standards,
- Other metal or plastic materials used do not comply with international standards,
- Not to use the teflon band sufficiently and suitably,
- Incorrect installation of the Clamp Saddles during installation,
- Damage of the threads of the Clamp Saddles during pipe drilling with the drill,
- Damage or displacing of the oring during the installation,

can cause leaking in your installation.

ISO 13460-1 STANDARDI - TESTLER

ISO 13460-1 STANDARD - TESTS



UZUN SÜRELİ İÇ HİDROSTATİK BASINCA DAYANIM TESTİ

Priz Kolyeler, ISO 1167-1 test standardına göre test edilmektedir.

RESISTANCE TO LONG-TERM INTERNAL HYDROSTATIC PRESSURE

Clamp Saddles are tested according to the ISO 1167-1 test standard.

MALZEME MATERIAL	PN PN	TEST SICAKLIĞI / (°C) TEST TEMPERATURE / (°C)	TEST SÜRESİ / (SAAT) TEST DURATION / (HOUR)	TEST BASINCI / (BAR) TEST PRESSURE / (BAR)
PP-H	16 BAR	20 95	1 1.000	42.0 7.0
PP-H	10 BAR	20 95	1 1.000	26.8 4.5
PP-H	6 BAR	20 95	1 1.000	12.8 2.8

* Test Basıncı değerleri, her çap için değişmekte olup, yaklaşık değerlerdir.

* Test pressure values are variable for each dimensions and are approximate values.



İÇ HİDROSTATİK BASINCA DAYANIM TESTİ

RESISTANCE TO SHORT-TERM INTERNAL HYDROSTATIC PRESSURE

PN PN	TEST SICAKLIĞI / (°C) TEST TEMPERATURE / (°C)	TEST SÜRESİ / (SAAT) TEST DURATION / (HOUR)	TEST BASINCI / (BAR) TEST PRESSURE / (BAR)
16 BAR	20	1	24.0
10 BAR	20	1	15.0
6 BAR	20	1	9.0



DAİRESEL KAYMA DİRENCİ TESTİ CIRCULAR SLIP RESISTANCE TEST

RESISTANCE TO PRESSURE DURING APPLICATION OF A BENDING MOMENT (M= 0,4D) TO THE BRANCH OUTLET

TEST SICAKLIĞI / (°C) TEST TEMPERATURE / (°C)	TEST MOMENTİ / (N.m) TEST MOMENT / (N.m)	TEST SÜRESİ / (DAKİKA) TEST DURATION / (MINUTE)
20 ± 3	0.4 x D	1

DİŞLER Priz Kolyeler için dişler, ISO 7-1 standardına uygundur.

THREADS Threads for Clamp Saddles are compatible with ISO 7-1 standard.

SU KALİTESİ ÜZERİNDEKİ ETKİSİ Ekleme parçaları, içme suyu üzerinde mikroorganizmaların çoğalmalarına izin vermemelidir. KIWA ve TSE kuruluşlarının laboratuvarları tarafından ilgili testler yapılarak raporlandırılmıştır.

INFLUENCE ON WATER QUALITY Compression Fittings must not allow increasing microorganism on drinking water. It is reported with the related tests by the laboratories of KIWA and TSE Institutions.

Because the nuts are inserted in their housing on the lower part, it provides quick and easy installation.



Somunlar, alt kapaktaki yuvalarına yerleştirildiği için hızlı ve kolay montaj yapılmasını sağlar.

PRİZ KOLYE GEÇMELİ

CLAMP SADDLES WITH SLIDE

СЕДЛОВЫЕ ВРЕЗКИ С ЗАЖИМОМ

ربط السرجي مع دبوس

Özellikler

- + Darbelere karşı dayanıklı, yüksek kaliteli polipropilen hammaddeden üretilmiştir.
- + Borulardaki ölçü farklılıklarından doğabilecek sızıntıları önleyebilecek şekilde tasarlanmıştır.
- + Oringi kauçuktan üretilmekte olup yüksek basınç altında sızdırmazlık sağlar.
- + Suyun kokusunu ve tadını değiştirebilecek zararlı bileşikler içermez.
- + ISO 13460-1 Standardına uygundur.

KULLANIM ALANLARI

- + Tarımsal Sulama
- + Seralar

GARANTİ VERİLEN BASINÇ DEĞERİ

Ø 25 mm – Ø 110 mm : PN 6

Specifications

- + It has been produced from high quality polypropylene raw material and it has resistance to impact.
- + It is designed to prevent leakage caused by the size differences of the pipes.
- + O-rings are made of rubber and provide leakproofness under high pressure.
- + It does not contain any harmful compounds which can change the taste or the smell of the water.
- + It is compatible with ISO 13460-1 Standard.

INSTALLATION AREAS

- + Agricultural Irrigation
- + Greenhouses

GUARANTEED PRESSURE VALUE

Ø 25 mm – Ø 110 mm : PN 6



TS ISO 13460-1



PRİZ KOLYE GEÇMELİ / CLAMP SADDLES WITH SLIDE

ربط السرجي مع دبوس/СЕДЛОВЫЕ ВРЕЗКИ С ЗАЖИМОМ

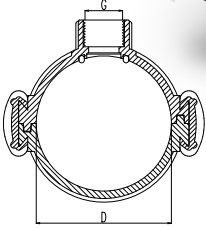

PRİZ KOLYE GEÇMELİ

CLAMP SADDLE WITH SLIDE
СЕДЛОВЫЕ ВРЕЗКИ С ЗАЖИМОМ
ربط السرجي مع دبوس

KOD CODE	EBAT / SIZE D x G	AMBALAJ ADEDİ PACKING QUANTITY	KOLİ ADEDİ BOX QUANTITY	ÇUVAL ADEDİ SACK QUANTITY
9311	25 x 1/2"	25	300	375
9321	32 x 1/2"	25	200	225
9322	32 x 3/4"	25	200	225
9331	40 x 1/2"	25	200	225
9332	40 x 3/4"	25	200	225
9341	50 x 1/2"	10	90	110
9342	50 x 3/4"	10	90	110
9343	50 x 1"	10	90	110
9351	63 x 1/2"	10	80	90
9352	63 x 3/4"	10	80	90
9353	63 x 1"	10	80	90
9361	75 x 1/2"	5	60	70
9362	75 x 3/4"	5	60	70
9363	75 x 1"	5	60	65
9371	90 x 1/2"	5	45	55
9372	90 x 3/4"	5	45	55
9373	90 x 1"	5	45	55
9381	110 x 1/2"	5	40	40
9382	110 x 3/4"	5	40	40
9383	110 x 1"	5	40	40

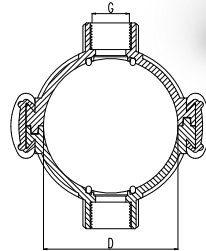

PRİZ KOLYE ÇİFT ÇIKIŞLI GEÇMELİ

DOUBLE ENDED CLAMP SADDLE WITH SLIDE
ДВУХСТОРОННИЕ СЕДЛОВЫЕ
ВРЕЗКИ С ЗАЖИМОМ
ربط السرجي مع دبوس مزدوجة

KOD CODE	EBAT / SIZE D x G	AMBALAJ ADEDİ PACKING QUANTITY	KOLİ ADEDİ BOX QUANTITY	ÇUVAL ADEDİ SACK QUANTITY
9411	25 x 1/2" x 1/2"	25	250	300
9421	32 x 1/2" x 1/2"	25	150	200
9422	32 x 3/4" x 3/4"	25	150	200
9431	40 x 1/2" x 1/2"	25	150	175
9432	40 x 3/4" x 3/4"	25	150	175
9441	50 x 1/2" x 1/2"	10	80	100
9442	50 x 3/4" x 3/4"	10	80	100
9443	50 x 1" x 1"	10	70	80
9451	63 x 1/2" x 1/2"	10	70	80
9452	63 x 3/4" x 3/4"	10	70	70
9453	63 x 1" x 1"	10	60	70
9461	75 x 1/2" x 1/2"	5	60	65
9462	75 x 3/4" x 3/4"	5	50	65
9463	75 x 1" x 1"	5	50	60
9471	90 x 1/2" x 1/2"	5	45	55
9472	90 x 3/4" x 3/4"	5	45	55
9473	90 x 1" x 1"	5	40	45
9481	110 x 1/2" x 1/2"	5	40	40
9482	110 x 3/4" x 3/4"	5	40	40
9483	110 x 1" x 1"	5	40	40

PRİZ KOLYE GEÇMELİ

CLAMP SADDLE WITH SLIDE

СЕДЛОВЫЕ ВРЕЗКИ С ЗАЖИМОМ

ربط السرجي مع دبوس

DİKKAT EDİLMESİ GEREKEN HUSUSLAR

- + Priz Kolyeler depolama ve montaj esnasında sert ve keskin cisimlerden uzak tutulmalıdır. Tesisat toprak altına döşenecekse, sert ve keskin cisimlerden korumak maksadıyla kum ile kapatılmalıdır. Hasar görmüş ürünler kesinlikle kullanılmamalıdır.
- + Priz kolyelerde oring, yuvasına düzgünce yerleştirilmeli ve montaj esnasında yerinden çıkmamasına özen gösterilmelidir.
- + Priz kolye ile kullanılacak erkek adaptörlere teflon bant sızdırmazlığı sağlayacak kadar ve sıkma yönüyle aynı yönde sarılmalıdır.
- + Priz kolyelerin montajından sonra yapılan boru delme işlemi, uygun bir matkap ucu ile dişlere değmeyecek şekilde gerçekleştirilmelidir.
- + Boruda standart değerinden daha büyük bir ölçü farklılığı var ise (> 0.5 mm) priz kolye montajında alt ve üst kapaklar birbirine değmeyecektir. Bu durumda priz kolyenin kamalarının sonuna kadar çakılmasına gerek yoktur.
- + Priz kolyelerin montajı sırasında kamalar karşılıklı monte edilmelidir.

POINTS TO TAKE INTO CONSIDERATION

- + Clamp saddles should be kept away from hard and sharp objects during the storage and installation. If the installation is laid under the ground, it should be covered with sand to protect it from hard and sharp objects. Any damaged adaptor should not be used absolutely.
- + The o-ring should be placed in its socket properly in order not to be unsettled during the installation.
- + Male adaptors which are going to be used with clamp saddles should be wrapped tight enough to prevent leakage towards fastening direction with a teflon band.
- + Drilling the pipe after the installation of Clamp Saddles can cause the damage of the threads. Thus, drilling must be carried out in a way that it does not touch the threads with a suitable drill bit.
- + If there is a size difference, larger than the standart dimensions (> 0.5 mm) in the pipe, upper and lower body parts will not contact each other during the clamp saddle installation. In this case, there is no need to drive in the wedges of the clamp saddle up to the end.
- + During the installation of the clamp saddles, wedges or bolts should be installed reciprocally.

YEŞİL SERİ KÜRESEL VANA

GREEN SERIES BALL VALVES

КРАНЫ ШАРОВЫЕ ЗЕЛЕНАЯ СЕРИЯ

اقفالة الخضراء

Özellikler

- + Darbelere karşı dayanıklı, yüksek kaliteli polipropilen hammaddeden üretilmiştir
- + Vananın her iki yönünden de akış sağlamak mümkündür.
- + Akışkan geçişinde basınç ve debi kaybına sebep olmaz.
- + Sisteminizde kolay montaj imkânı sağlar.
- + O-ring kauçuktan üretilmekte olup yüksek basınç altında sızdırmazlık sağlar.
- + Suyun kokusunu ve tadını değiştirebilecek zararlı bileşikler içermez.

Specifications

- + It has been produced from high quality polypropylene raw material and it has resistance to impact.
- + It is possible to provide bidirectional flow in the valve.
- + They do not cause any pressure or flow loss during fluid pass.
- + They supply simple installation in your system.
- + O-rings are made of rubber and provide leakproofness under high pressure.
- + It does not contain any harmful compounds which can change the taste or the smell of the water.

GARANTİ VERİLEN BASINÇ DEĞERİ : PN 10
GUARANTEED PRESSURE VALUE : PN 10



TS ISO 9911

KULLANIM ALANLARI

- + Peyzaj Sektörü
- + Tarımsal Sulama

INSTALLATION AREAS

- + Landscaping Systems
- + Agricultural Irrigation



YEŞİL SERİ KÜRESEL VANA / GREEN SERIES BALL VALVES

KOD CODE	EBAT / SIZE G x D	AMBALAJ ADEDİ PACKING QUANTITY	KOLİ ADEDİ BOX QUANTITY
99122	¾" x ¾"	4	140
99123	¾" x 1"	4	128
99132	1" x ¾"	4	140
99133	1" x 1"	4	128
99134	1" x 1 ¼"	4	64
99143	1 ¼" x 1"	4	64
99144	1 ¼" x 1 ¼"	4	64
99145	1 ¼" x 1 ½"	2	40
99154	1 ½" x 1 ¼"	2	40
99155	1 ½" x 1 ½"	2	40
99156	1 ½" x 2"	2	32
99165	2" x 1 ½"	2	30
99166	2" x 2"	2	30

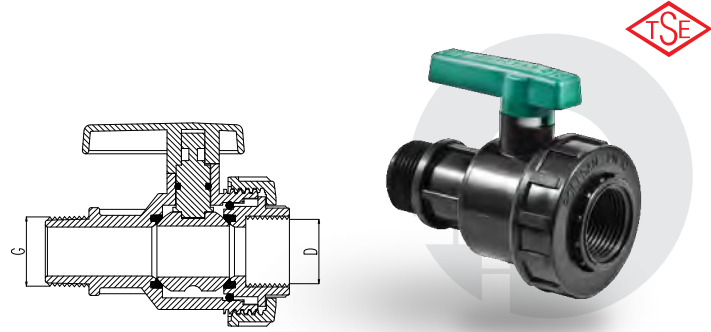

KÜRESEL VANA ERKEK - Dişi

BALL VALVE MALE - FEMALE
КРАН ШАРОВОЙ НАРУЖНАЯ РЕЗЬБА - ВНУТРЕННЯЯ РЕЗЬБА
اقفالة سن خارج- سن داخل

KOD CODE	EBAT / SIZE G x d	AMBALAJ ADEDİ PACKING QUANTITY	KOLİ ADEDİ BOX QUANTITY
99234	1" x 40	4	48
99244	1 ¼" x 40	4	44
99245	1 ¼" x 50	2	30
99255	1 ½" x 50	2	28
99256	1 ½" x 63	2	18
99266	2" x 63	2	18

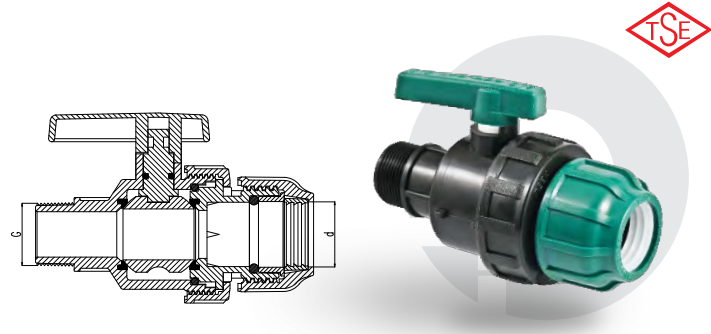

KÜRESEL VANA ERKEK - KABLİN

BALL VALVE MALE - COUPLING
КРАН ШАРОВОЙ НАРУЖНАЯ РЕЗЬБА - МУФТА
اقفالة سن خارج- رباطة

KOD CODE	EBAT / SIZE G x D	AMBALAJ ADEDİ PACKING QUANTITY	KOLİ ADEDİ BOX QUANTITY
99322	¾" x ¾"	4	140
99332	1" x ¾"	4	140
99333	1" x 1"	4	140
99343	1 ¼" x 1"	4	60
99344	1 ¼" x 1 ¼"	4	64
99354	1 ½" x 1 ¼"	2	48
99355	1 ½" x 1 ½"	2	48
99365	2" x 1 ½"	2	30
99366	2" x 2"	2	30

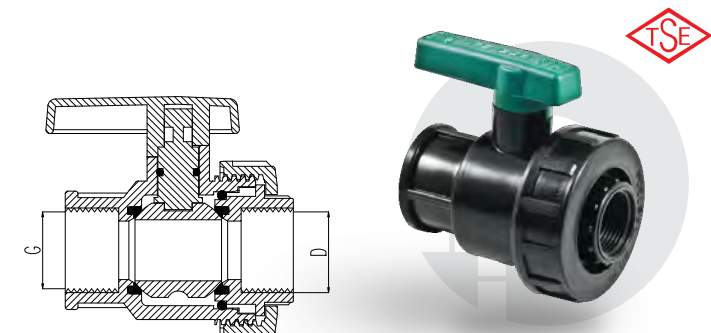

KÜRESEL VANA Dişi - Dişi

BALL VALVE FEMALE - FEMALE
КРАН ШАРОВОЙ ВНУТРЕННЯЯ РЕЗЬБА - ВНУТРЕННЯЯ РЕЗЬБА
اقفالة سن داخل- سن داخل

اقفالة الخضراء / КРАНЫ ШАРОВЫЕ ЗЕЛЕНАЯ СЕРИЯ

Lütfen ürünlerin ambalaj bilgisi için bkz: Sayfa 158

YEŞİL SERİ KÜRESEL VANA / GREEN SERIES BALL VALVES

اقفالة الخضراء / КРАНЫ ШАРОВЫЕ ЗЕЛЕНАЯ СЕРИЯ

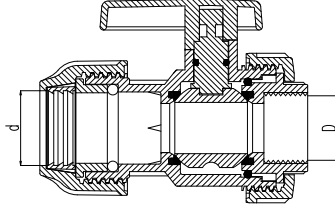

KÜRESEL VANA KABLİN - DiŞİ

BALL VALVE COUPLING - FEMALE
КРАН ШАРОВОЙ МУФТА - ВНУТРЕННЯЯ РЕЗЬБА
اقفالة رباطة- سن داخل

KOD CODE	EBAT / SIZE d x D	AMBALAJ ADEDİ PACKING QUANTITY	KOLİ ADEDİ BOX QUANTITY
99432	32 x 3/4"	4	100
99433	32 x 1"	4	100
99443	40 x 1"	4	48
99444	40 x 1 1/4"	4	48
99454	50 x 1 1/4"	2	40
99455	50 x 1 1/2"	2	36
99465	63 x 1 1/2"	2	20
99466	63 x 2"	2	20

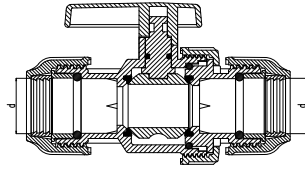

KÜRESEL VANA KABLİN - KABLİN

BALL VALVE COUPLING - COUPLING
КРАН ШАРОВОЙ МУФТА - МУФТА
اقفالة رباطة-رباطة

KOD CODE	EBAT / SIZE d x d	AMBALAJ ADEDİ PACKING QUANTITY	KOLİ ADEDİ BOX QUANTITY
99544	40 x 40	4	36
99555	50 x 50	2	24
99566	63 x 63	2	16

Lütfen ürünlerin ambalaj bilgisi için bkz: Sayfa 158

MAVİ SERİ KÜRESEL VANA

BLUE SERIES BALL VALVES
КРАНЫ ШАРОВЫЕ СИНЯЯ СЕРИЯ

اقفالة الزرقاء

Özellikler

- + Darbelere karşı dayanıklı, yüksek kaliteli polipropilen hammaddeden üretilmiştir
- + Vananın her iki yönünden de akış sağlamak mümkündür.
- + Akışkan geçişinde **basınç ve debi** kaybına sebep olmaz.
- + Sisteminizde **kolay montaj** imkânı sağlar.
- + Oring kauçuktan üretilmekte olup **yüksek basınç altında sızdırmazlık** sağlar.
- + Suyun kokusunu ve tadını değiştirebilecek **zararlı bileşikler içermez**.

Specifications

- + It has been produced from high quality polypropylene raw material and **it has resistance to impact**.
- + **It is possible to provide bidirectional flow** in the valve.
- + They do not cause any **pressure or flow** loss during fluid transition.
- + They supply **simple installation** in your system.
- + O-rings are made of rubber and **provide leakproofness under high pressure**.
- + It does not contain any **harmful compounds** which can change the taste or the smell of the water.

GARANTİ VERİLEN BASINÇ DEĞERLERİ

1/2" - 3/4" - 1" - 1 1/4" - 1 1/2" - 2" Küresel Vanalar : PN 10

2 1/2" - 3" - 4" Küresel Vanalar : PN 6

GUARANTEED PRESSURE VALUES

1/2" - 3/4" - 1" - 1 1/4" - 1 1/2" - 2" Ball Valves : PN 10

2 1/2" - 3" - 4" Ball Valves : PN 6



TS ISO 9911

KULLANIM ALANLARI

- + Peyzaj Sektörü
- + Tarımsal Sulama

INSTALLATION AREAS

- + Landscaping Systems
- + Agricultural Irrigation



MAVİ SERİ KÜRESEL VANA / BLUE SERIES BALL VALVES

اقفالة الزرقاء/السرية/سرية

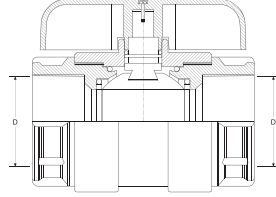

KÜRESEL VANA DIŞI - DIŞI

BALL VALVE FEMALE - FEMALE

КРАН ШАРОВОЙ ВНУТРЕННЯЯ РЕЗЬБА - ВНУТРЕННЯЯ РЕЗЬБА

اقفالة سن داخل- سن داخل

KOD CODE	EBAT / SIZE D x D	AMBALAJ ADEDİ PACKING QUANTITY	KOLİ ADEDİ BOX QUANTITY
993711	1/2" x 1/2"	10	200
993722	3/4" x 3/4"	6	132
993733	1" x 1"	5	100
993744	1 1/4" x 1 1/4"	4	72
993755	1 1/2" x 1 1/2"	4	56
993766	2" x 2"	2	28
993777	2 1/2" x 2 1/2"	2	16
993788	3" x 3"	1	8
993799	4" x 4"	1	8

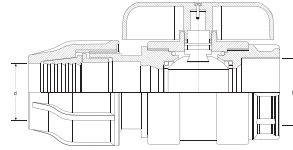

KÜRESEL VANA KABLİN - DIŞI

BALL VALVE COUPLING - FEMALE

КРАН ШАРОВОЙ МУФТА - ВНУТРЕННЯЯ РЕЗЬБА

اقفالة رباطة- سن داخل

KOD CODE	EBAT / SIZE d x D	AMBALAJ ADEDİ PACKING QUANTITY	KOLİ ADEDİ BOX QUANTITY
994711	20 x 1/2"	10	180
994722	25 x 3/4"	6	120
994733	32 x 1"	5	75
994744	40 x 1 1/4"	4	52
994755	50 x 1 1/2"	4	40
994766	63 x 2"	2	18

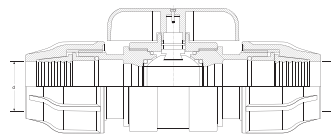

KÜRESEL VANA KABLİN - KABLİN

BALL VALVE COUPLING - COUPLING

КРАН ШАРОВОЙ МУФТА - МУФТА

اقفالة رباطة-رباطة

KOD CODE	EBAT / SIZE d x d	AMBALAJ ADEDİ PACKING QUANTITY	KOLİ ADEDİ BOX QUANTITY
995711	20 x 20	10	150
995722	25 x 25	6	90
995733	32 x 32	5	60
995744	40 x 40	4	44
995755	50 x 50	4	32
995766	63 x 63	2	16

Lütfen ürünlerin ambalaj bilgisi için bkz: Sayfa 158

YEŞİL/MAVİ SERİ KÜRESEL VANA

GREEN / BLUE SERIES BALL VALVES

КРАНЫ ШАРОВЫЕ /ЗЕЛЕНАЯ СИННЯЯ СЕРИЯ

اقفالة الزرقاء اقفالة الخضراء

DİKKAT EDİLMESİ GEREKEN HUSUSLAR

- + Kullanılacak sistemde Filtre kullanılmalıdır.
- + Filtre kullanılmayan durumlarda vana içerisindeki parçalar zarar görebilir, çalışma ömrü kısalmır.
- + Vanalar sökülüp takılabilen parçalardan meydana gelmektedir. Sökülen parçaların tekrar yerine doğru montajı yapılmalıdır.
- + Dişli kısımların montajında teflon vb. sızdırmazlık elemanı kullanılmalıdır.
- + Küresel vanalar su dışındaki akışkanlar için kullanıma uygun değildir.

POINTS TO TAKE INTO CONSIDERATION

- + The filter should be used in the system.
- + When the filter is not used, the parts inside the valve may be damaged, and the working life will be shortened.
- + Valves consist of parts that can be disassembled, and assembled. The dismantled parts must be assembled correctly.
- + Sealing elements such as Teflon etc. should be used in the assembly of the threaded parts.
- + Ball valves are not suitable for fluids other than water.

VANA KUTULARI

VALVE BOXES

КЛАПАННАЯ КОРОБКА

صناديق

Özellikler

- + **Yüksek kaliteli** polipropilen hammaddeden üretilmiştir.
- + Toprak altına döşenmiş sistem ekipmanlarına **kolay ulaşım** sağlar.
- + Kapak içerisinde **özel tasarım plastik kilit sistemi** mevcuttur.
- + Boru geçişleri için boru çaplarına göre **özel kesimli** delikler bulunmaktadır.

Specifications

- + It has been produced from **high quality** polypropylene raw material.
- + It enables **easy access** to the system equipment which is laid underground.
- + **Specially designed plastic lock system** is available in the lid.
- + There are **specially cut** holes according to pipe diameters for the passages of pipe.

KULLANIM ALANLARI

- + Peyzaj Sektörü
- + Tarımsal Sulama
- + İnşaat Sektörü

INSTALLATION AREAS

- + Landscaping Systems
- + Agricultural Irrigation
- + Construction



TS 13716



VANA KUTUSU / VALVE BOX

КЛАПАННАЯ КОРОБКА

صندوق

KOD CODE	EBAT SIZE	AMBALAJ ADEDİ PACKING QUANTITY	PALET ADEDİ PALLET QUANTITY		
73006	6"	1	360		
YÜKSEKLİK / HEIGHT		UZUNLUK / LENGTH		GENİŞLİK / WIDTH	
H (mm)	L ₁ (mm)	L ₂ (mm)	W ₁ (mm)	W ₂ (mm)	
235	163	260	163	260	

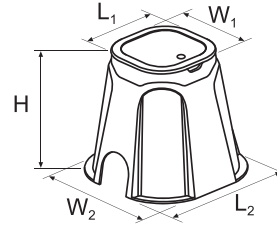

VANA KUTUSU / VALVE BOX

КЛАПАННАЯ КОРОБКА

صندوق

KOD CODE	EBAT SIZE	AMBALAJ ADEDİ PACKING QUANTITY	PALET ADEDİ PALLET QUANTITY		
73010	10"	1	240		
YÜKSEKLİK / HEIGHT		UZUNLUK / LENGTH		GENİŞLİK / WIDTH	
H (mm)	L ₁ (mm)	L ₂ (mm)	W ₁ (mm)	W ₂ (mm)	
275	240	375	240	375	

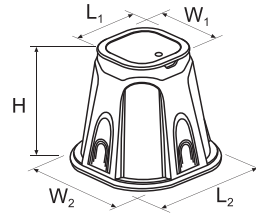

VANA KUTUSU / VALVE BOX

КЛАПАННАЯ КОРОБКА

صندوق

KOD CODE	EBAT SIZE	AMBALAJ ADEDİ PACKING QUANTITY	PALET ADEDİ PALLET QUANTITY		
73012	12"	1	120		
YÜKSEKLİK / HEIGHT		UZUNLUK / LENGTH		GENİŞLİK / WIDTH	
H (mm)	L ₁ (mm)	L ₂ (mm)	W ₁ (mm)	W ₂ (mm)	
310	385	553	255	420	

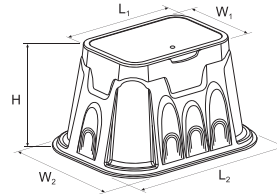

VANA KUTUSU / VALVE BOX

КЛАПАННАЯ КОРОБКА

صندوق

KOD CODE	EBAT SIZE	AMBALAJ ADEDİ PACKING QUANTITY	PALET ADEDİ PALLET QUANTITY		
73014	14" (jumbo)	1	50		
YÜKSEKLİK / HEIGHT		UZUNLUK / LENGTH		GENİŞLİK / WIDTH	
H (mm)	L ₁ (mm)	L ₂ (mm)	W ₁ (mm)	W ₂ (mm)	
310	505	673	355	520	

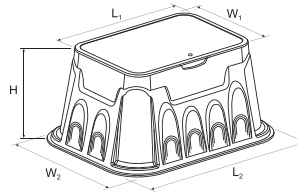

VANA KUTUSU ANAHTARI

VALVE BOX WRENCH

КЛЮЧ К КЛАПАННОЙ КОРОБКЕ

مفتاح صندوق

KOD CODE	EBAT SIZE-mm	AMBALAJ ADEDİ PACKING QUANTITY
73001	8	10

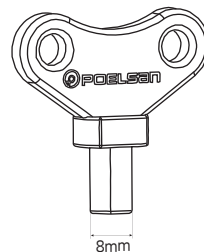

صندوق كلاباننا كوربكا / КЛАПАННАЯ КОРОБКА

VANA KUTULARI

VALVE BOXES

КЛАПАННАЯ КОРОБКА

صناديق

DİKKAT EDİLMESİ GEREKEN HUSUSLAR

- + Keskin köşeli darbelere karşı koruyunuz.
- + Boru çaplarına göre özel kesimli delikler testere yardımı ile ihtiyaca göre kesilmelidir.
- + Kilit sistemini açmak için 8 mm alyan anahtar kullanılmalıdır.

POINTS TO TAKE INTO CONSIDERATION

- + Protect against sharp-edged impacts.
- + Special cut holes according to pipe diameters should be cut by means of a saw according to need.
- + 8 mm allen key must be used to unlock the locking system.

LAYFLAT EK PARÇALARI & ÇIKIŞ NİPELLERİ

LAYFLAT FITTINGS & OFFTAKE NIPPLES

ФИТИНГИ ЛАЙФЛЕТ И ВЫХОДНЫЕ НИППЕЛИ

مواد ربط المرنة و زبانة

Özellikler

- + Darbelere karşı dayanıklı, yüksek kaliteli polipropilen hammaddeden üretilmiştir.
- + Oringi kauçuktan üretilmekte olup yüksek basınç altında sızdırmazlık sağlar.
- + İç yüzeyleri homojen ve gözeneksizdir.
- + Suyun kokusunu ve tadını değiştirebilecek zararlı bileşikler içermez.

Specifications

- + It has been produced from high quality polypropylene raw material and it has resistance to impact.
- + O-rings are made of rubber and provide leakproofness under high pressure.
- + It has a homogeneous and non-porous inner surface.
- + It does not contain any harmful compounds which can change the taste or the smell of the water.

GARANTİ VERİLEN BASINÇ DEĞERLERİ GUARANTEED PRESSURE VALUES

2" - 2 ½" : PN 10
3" - 4" - 5" : PN 6
6" : PN 4

ÖLÇÜ SIZE	LAYFLAT BORU İÇ ÇAP LAYFLAT PIPE INTERNAL DIAMETER
2"	52 mm
2 ½"	65 mm
3"	77 mm
4"	103 mm
5"	128 mm
6"	153 mm

KULLANIM ALANLARI

- + Tarımsal Sulama Sistemleri
- + Damla Sulama Sistemleri
- + Yağmurlama Sulama Sistemleri
- + Drenaj Sistemleri
- + Açık Alan Sulama Sistemleri
- + Madencilik Sektörü
- + İnşaat Sektörü

INSTALLATION AREAS

- + Agricultural Irrigation Systems
- + Drip Irrigation Systems
- + Sprinkler Irrigation Systems
- + Drainage Systems
- + Open Field Irrigation Systems
- + Mining Sector
- + Construction Sector



LAYFLAT EK PARÇALARI / LAYFLAT FITTINGS

مواد ربط المرنة و زبانة / LAYFLAT ФИТИНГИ

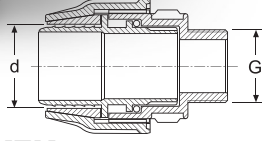

LAYFLAT ERKEK

LAYFLAT MALE ADAPTOR

ЛАЙФЛЕТ С НАРУЖНОЙ РЕЗЬБОЙ

بداية سن خارج خرطوم الري

KOD CODE	EBAT / SIZE d x G	AMBALAJ ADEDİ PACKING QUANTITY	KOLİ ADEDİ BOX QUANTITY	ÇUVAL ADEDİ SACK QUANTITY
71155	2" x 2"	10	70	80
71165	2 1/2" x 2"	6	48	48
71166	2 1/2" x 2 1/2"	6	48	48
71177	3" x 3"	4	28	28
71187	4" x 3"	4	16	20
71188	4" x 4"	4	12	16
71198	5" x 4"	2	10	12
71199	5" x 5"	2	10	10
7119908	6" x 4"	2	4	6
7119909	6" x 5"	2	4	6

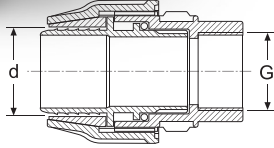

LAYFLAT DIŞİ

LAYFLAT FEMALE ADAPTOR

ЛАЙФЛЕТ С ВНУТРЕННЕЙ РЕЗЬБОЙ

بداية سن داخل خرطوم الري

KOD CODE	EBAT / SIZE d x G	AMBALAJ ADEDİ PACKING QUANTITY	KOLİ ADEDİ BOX QUANTITY	ÇUVAL ADEDİ SACK QUANTITY
71255	2" x 2"	10	70	70
71266	2 1/2" x 2 1/2"	6	42	42
71277	3" x 3"	4	28	28
71288	4" x 4"	4	12	16
71298	5" x 4"	2	12	10
71299	5" x 5"	2	8	10
7129909	6" x 5"	2	4	6

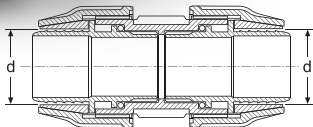

LAYFLAT MANŞON

LAYFLAT COUPLING

ЛАЙФЛЕТ МУФТА

رباطة خرطوم الري

KOD CODE	EBAT / SIZE d x d	AMBALAJ ADEDİ PACKING QUANTITY	KOLİ ADEDİ BOX QUANTITY	ÇUVAL ADEDİ SACK QUANTITY
71355	2" x 2"	6	42	48
71366	2 1/2" x 2 1/2"	5	25	30
71377	3" x 3"	2	16	18
71388	4" x 4"	2	8	10
71399	5" x 5"	1	6	7
7139910	6" x 6"	1	2	4

LAYFLAT EK PARÇALARI / LAYFLAT FITTINGS

مواد ربط المرنة و زبانة / LAYFLAT ФИТИНГИ

KOD CODE	EBAT / SIZE d x d x d	AMBALAJ ADEDİ PACKING QUANTITY	KOLİ ADEDİ BOX QUANTITY	ÇUVAL ADEDİ SACK QUANTITY
71455	2" x 2" x 2"	4	28	28
71466	2 1/2" x 2 1/2" x 2 1/2"	3	15	15
71477	3" x 3" x 3"	1	10	9
71488	4" x 4" x 4"	1	4	5
71499	5" x 5" x 5"	1	2	3
7149910	6" x 6" x 6"	1	1	2

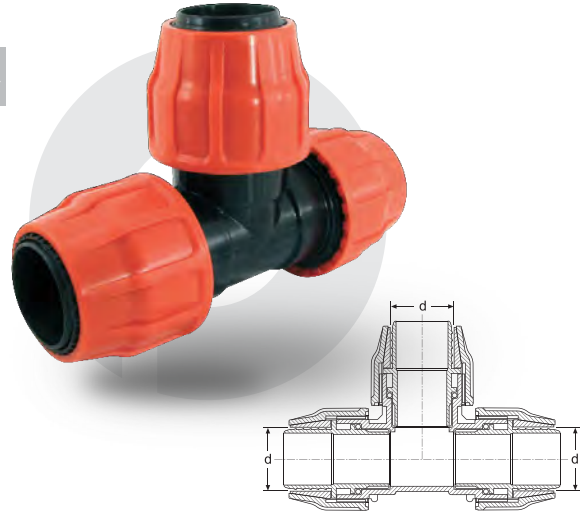

LAYFLAT TE

LAYFLAT TEE

ЛАЙФЛЕТ ТРОЙНИК

تقسم سن خارج خرطوم الري

KOD CODE	EBAT / SIZE d x G x d	AMBALAJ ADEDİ PACKING QUANTITY	KOLİ ADEDİ BOX QUANTITY	ÇUVAL ADEDİ SACK QUANTITY
71555	2" x 2" x 2"	4	32	32
71566	2 1/2" x 2 1/2" x 2 1/2"	3	15	18
71577	3" x 3" x 3"	1	12	12
71588	4" x 4" x 4"	1	6	6
71598	5" x 4" x 5"	1	4	5
71599	5" x 5" x 5"	1	4	4
7159908	6" x 4" x 6"	1	2	2
7159909	6" x 5" x 6"	1	2	2

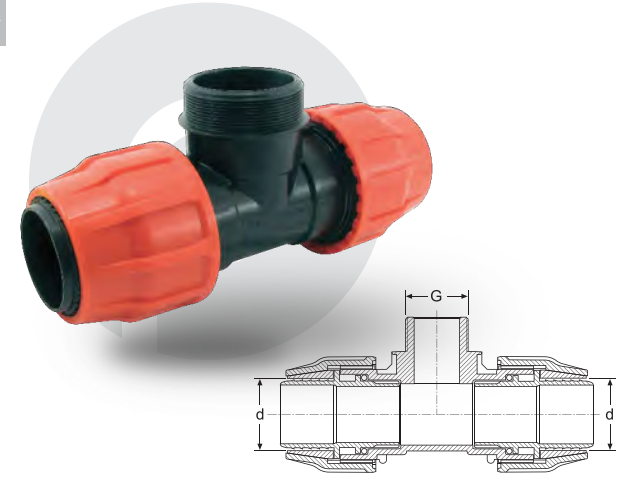

LAYFLAT ERKEK TE

LAYFLAT MALE TEE

ЛАЙФЛЕТ ТРОЙНИК С НАРУЖНОЙ РЕЗЬБОЙ

تقسم سن داخل خرطوم الري

KOD CODE	EBAT / SIZE d x G x d	AMBALAJ ADEDİ PACKING QUANTITY	KOLİ ADEDİ BOX QUANTITY	ÇUVAL ADEDİ SACK QUANTITY
71655	2" x 2" x 2"	4	24	28
71666	2 1/2" x 2 1/2" x 2 1/2"	3	15	15
71677	3" x 3" x 3"	1	12	11
71688	4" x 4" x 4"	1	5	7
71698	5" x 4" x 5"	1	4	4
71699	5" x 5" x 5"	1	3	4
7169909	6" x 5" x 6"	1	2	2

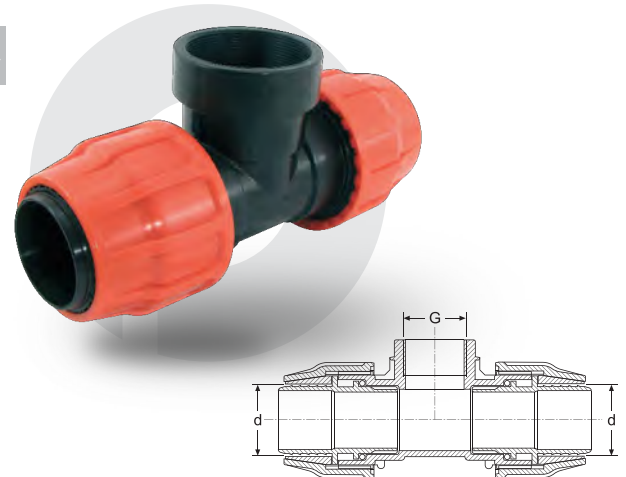

LAYFLAT DIŞİ TE

LAYFLAT FEMALE TEE

ЛАЙФЛЕТ ТРОЙНИК С ВНУТРЕННЕЙ РЕЗЬБОЙ

تقسيم خرطوم الري

LAYFLAT EK PARÇALARI / LAYFLAT FITTINGS

مواد ربط المرنة و زبانة / LAYFLAT ФИТИНГИ

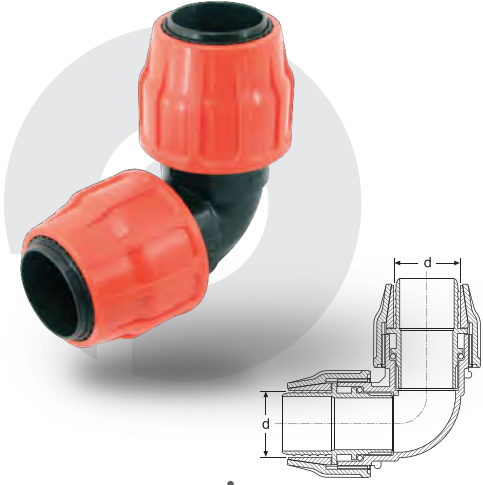

LAYFLAT DİRSEK

LAYFLAT ELBOW
ЛАЙФЛЕТ УГОЛ
عكس خرطوم الري

KOD CODE	EBAT / SIZE d x d	AMBALAJ ADEDİ PACKING QUANTITY	KOLİ ADEDİ BOX QUANTITY	ÇUVAL ADEDİ SACK QUANTITY
71755	2" x 2"	4	40	44
71766	2 1/2" x 2 1/2"	4	20	28
71777	3" x 3"	2	14	16
71788	4" x 4"	1	7	9
71799	5" x 5"	1	4	5
7179910	6" x 6"	1	2	3

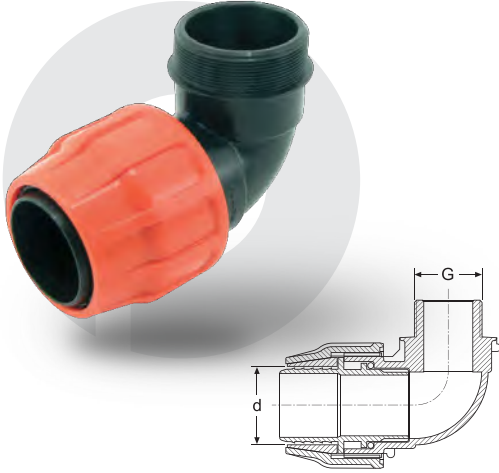

LAYFLAT ERKEK DİRSEK

LAYFLAT MALE ELBOW
ЛАЙФЛЕТ УГОЛ С НАРУЖНОЙ РЕЗЬБОЙ
عكس سن خارج خرطوم الري

KOD CODE	EBAT / SIZE d x G	AMBALAJ ADEDİ PACKING QUANTITY	KOLİ ADEDİ BOX QUANTITY	ÇUVAL ADEDİ SACK QUANTITY
71855	2" x 2"	4	56	60
71866	2 1/2" x 2 1/2"	4	36	32
71877	3" x 3"	2	18	22
71888	4" x 4"	1	11	12
71898	5" x 4"	1	8	9
71899	5" x 5"	1	6	8
7189909	6" x 5"	1	4	4

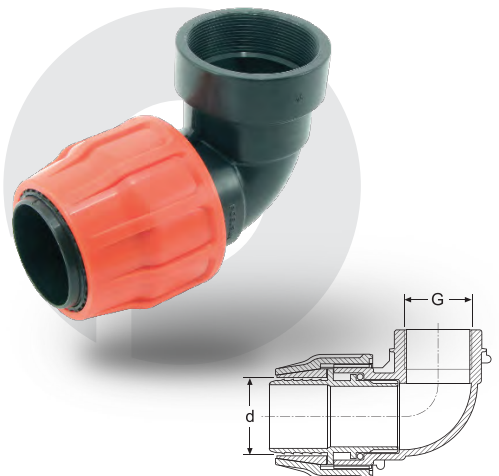

LAYFLAT DIŞİ DİRSEK

LAYFLAT FEMALE ELBOW
ЛАЙФЛЕТ УГОЛ С ВНУТРЕННЕЙ РЕЗЬБОЙ
عكس سن داخل خرطوم الري

KOD CODE	EBAT / SIZE d x G	AMBALAJ ADEDİ PACKING QUANTITY	KOLİ ADEDİ BOX QUANTITY	ÇUVAL ADEDİ SACK QUANTITY
71955	2" x 2"	4	48	56
71966	2 1/2" x 2 1/2"	4	32	32
71977	3" x 3"	2	20	22
71988	4" x 4"	1	11	13
71998	5" x 4"	1	6	8
71999	5" x 5"	1	6	8
7199909	6" x 5"	1	4	4

LAYFLAT EK PARÇALARI / LAYFLAT FITTINGS

مواد ربط المرنة و زبانه / LAYFLAT ФИТИНГИ

KOD CODE	EBAT / SIZE d x d ₁ x d	AMBALAJ ADEDİ PACKING QUANTITY	KOLİ ADEDİ BOX QUANTITY	ÇUVAL ADEDİ SACK QUANTITY
72065	2 1/2" x 2" x 2 1/2"	3	15	18
72076	3" x 2 1/2" x 3"	1	11	11
72087	4" x 3" x 4"	1	6	6
72098	5" x 4" x 5"	1	2	4
7209908	6" x 4" x 6"	1	2	2
7209909	6" x 5" x 6"	1	2	2

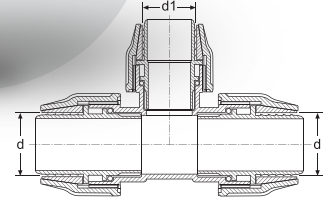

LAYFLAT REDÜKSİYON TE

LAYFLAT REDUCING TEE

ЛАЙФЛЕТ ТРОЙНИК ПЕРЕХОДНОЙ

تقسيم مصغرة خرطوم الري

KOD CODE	EBAT / SIZE d x d ₁	AMBALAJ ADEDİ PACKING QUANTITY	KOLİ ADEDİ BOX QUANTITY	ÇUVAL ADEDİ SACK QUANTITY
72165	2 1/2" x 2"	6	30	36
72176	3" x 2 1/2"	2	18	22
72187	4" x 3"	2	10	12
72198	5" x 4"	1	6	8
7219908	6" x 4"	1	6	5
7219909	6" x 5"	1	4	5

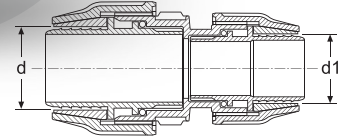

LAYFLAT REDÜKSİYON MANŞON

LAYFLAT REDUCING COUPLING

ЛАЙФЛЕТ МУФТА ПЕРЕХОДНАЯ

رباطة مصغرة خرطوم الري

KOD CODE	EBAT / SIZE d	AMBALAJ ADEDİ PACKING QUANTITY	KOLİ ADEDİ BOX QUANTITY	ÇUVAL ADEDİ SACK QUANTITY
72255	2"	12	84	96
72266	2 1/2"	6	54	54
72277	3"	4	32	32
72288	4"	4	16	20
72299	5"	2	12	12
7229910	6"	2	4	6

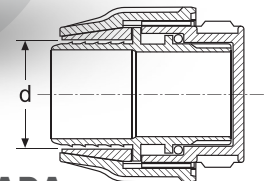

LAYFLAT KÖR TAPA

LAYFLAT END CAP

ЛАЙФЛЕТ ЗАГЛУШКА

سدادة خرطوم الري

LAYFLAT ÇIKIŞ NİPELLERİ / LAYFLAT OFFTAKE NIPPLES

زبانه قابلہ للتشتيت مسننة خرطوم الري / لایفلت خروجی رزبوی نپل / لایفلت خروجی زائرنی نپل



KOD CODE	G SIZE-mm	AMBALAJ ADEDİ PACKING QUANTITY	KOLİ ADEDİ BOX QUANTITY	ÇUVAL ADEDİ SACK QUANTITY
72500	1/2"	50	900	1000

LAYFLAT DIŞLİ ÇIKIŞ NİPELİ

LAYFLAT THREADED OFFTAKE NIPPLE
 ЛАЙФЛЕТ ВЫХОДНОЙ РЕЗЬБОВОЙ НИППЕЛЬ
 زبانه قابلہ للتشتيت مسننة خرطوم الري

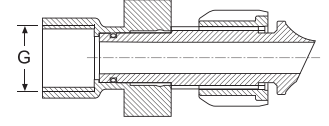

KOD CODE	G SIZE-mm	AMBALAJ ADEDİ PACKING QUANTITY	KOLİ ADEDİ BOX QUANTITY	ÇUVAL ADEDİ SACK QUANTITY
72511	16	50	1000	1000
72512	20	50	900	900

LAYFLAT KURTAĞZI ÇIKIŞ NİPELİ

LAYFLAT BARBED OFFTAKE NIPPLE
 ЛАЙФЛЕТ ВЫХОДНОЙ ЗАЕРШЕННЫЙ НИППЕЛЬ
 زبانه قابلہ للتشتيت شائكة خرطوم الري

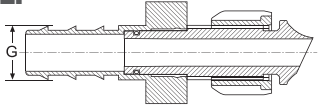

KOD CODE	G SIZE-mm	AMBALAJ ADEDİ PACKING QUANTITY	KOLİ ADEDİ BOX QUANTITY	ÇUVAL ADEDİ SACK QUANTITY
72531	17	50	900	900
72532	22	50	600	700

LAYFLAT YASSI DAMLAMA ÇIKIŞ NİPELİ

LAYFLAT TAPE OFFTAKE NIPPLE
 ЛАЙФЛЕТ ВЫХОДНОЙ НИППЕЛЬ
 ДЛЯ КАПЕЛЬНОЙ ЛЕНТЫ
 زبانه قابلہ للتشتيت شريطية خرطوم الري

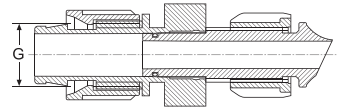

KOD CODE	G SIZE-mm	AMBALAJ ADEDİ PACKING QUANTITY	KOLİ ADEDİ BOX QUANTITY	ÇUVAL ADEDİ SACK QUANTITY
72541	17	50	1000	1100

LAYFLAT YÜZÜKLÜ YASSI DAMLAMA ÇIKIŞ NİPELİ

LAYFLAT TAPE (WITH RING) OFFTAKE NIPPLE
 ЛАЙФЛЕТ ВЫХОДНОЙ НИППЕЛЬ
 С ПОДЖИМОМ ДЛЯ КАПЕЛЬНОЙ ЛЕНТЫ
 زبانه قابلہ للتشتيت شريطية (مع الحلقة) خرطوم الري

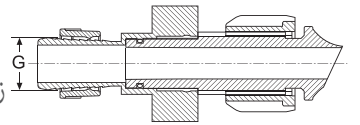

KABLİN ANAHTARI

FITTING SPANNER
 соединительный ключ
 مفتاح مواد ربط

KOD CODE	EBAT SIZE-mm	GÖVDE EBADİ BODY SIZE	AMBALAJ AD. PACKING QTY.	KOLİ AD. BOX QTY.	ÇUVAL AD. SACK QTY.
4936	32 - 63	2" - 2 1/2"	5	150	150
4969	63 - 110	3" - 4" - 5"	5	45	50
49699	125	6"	2	24	22

LAYFLAT EK PARÇALARI & ÇIKIŞ NİPELLERİ

LAYFLAT FITTINGS & OFFTAKE NIPPLES
ФИТИНГИ ЛАЙФЛЕТ И ВЫХОДНЫЕ НИППЕЛИ
مواد ربط المرنة و زبانه

DİKKAT EDİLMESİ GEREKEN HUSUSLAR

- + Layflat Çıkış Nipelleri ile çıkış almak için delik çapı 13 mm olacak şekilde boru delinmelidir.
- + Layflat Ek Parçalarının boruya montajı sırasında Layflat Boru katlama noktasının dış boru tutucu üzerindeki açık kanallara denk gelmemesine dikkat edilmelidir.

POINTS TO TAKE INTO CONSIDERATION

- + To get offtake with Layflat Offtake Nipple, the pipe should be drilled according to the hole diameter to be 13 mm.
- + During the assembling of Layflat Fittings, it should be avoided to Layflat Pipe folding point to come up to the opened channels on the outer pipe holder.

DİŐLİ BAĐLANTI ELEMANLARI

THREADED FITTINGS
РЕЗЬБОВЫЕ ФИТИНГИ
مواد الربط المسننة

Özellikler

- + Darbelere karşı dayanıklı, yüksek kaliteli polipropilen hammaddeden üretilmiştir.
- + UV ışınlarını geçirmediđi için yosunlanmaya ve bakteri üremesine izin vermez.
- + İç yüzeyleri homojen ve gözeneksizdir.
- + Suyun kokusunu ve tadını deđiştirebilecek zararlı bileşikler içermez.

MTT-100 Kollektör Te

- + BSP diő vanalar ve vana manifoldu kurmak için kullanılır.
- + Kurulum için araç gerektirmez.
- + Kendinden o-ringlidir, kollektörler arasında sızdırmazlık sağlar.

GARANTİ VERİLEN BASINÇ DEĐERİ : PN 10
GUARANTEED PRESSURE VALUE : PN 10

KULLANIM ALANLARI

- + Peyzaj Sektörü
- + Tarımsal Sulama

INSTALLATION AREAS

- + Landscaping Systems
- + Agricultural Irrigation

Specifications

- + It has been produced from high quality polypropylene raw material and it has resistance to impact.
- + They prevent alga and bacteria forming due to UV proof (ultraviolet beam) structure.
- + It has a homogeneous and non-porous inner surface.
- + It does not contain any harmful compounds which can change the taste or the smell of the water.

MTT-100 Collector Tee

- + BSP Thread is used to install female valves, and valve manifold.
- + It does not require tools for installation.
- + It has self a o-ring providing leakproofness between collectors.



DIŞLİ BAĞLANTI ELEMANLARI / THREADED FITTINGS

مواد الربط المسننة / РЕЗЬБОВЫЕ ФИТИНГИ

KOD CODE	EBAT / SIZE G x G x G	AMBALAJ ADEDİ PACKING QUANTITY	KOLİ ADEDİ BOX QUANTITY	ÇUVAL ADEDİ SACK QUANTITY
13111	1/2" x 1/2" x 1/2"	25	750	800
13112	1/2" x 3/4" x 1/2"	25	600	650
13121	3/4" x 1/2" x 3/4"	25	600	650
13122	3/4" x 3/4" x 3/4"	25	600	650
13123	3/4" x 1" x 3/4"	25	550	550
13131	1" x 1/2" x 1"	25	400	450
13132	1" x 3/4" x 1"	25	400	450
13133	1" x 1" x 1"	25	400	450
13141	1 1/4" x 1/2" x 1 1/4"	15	210	270
13142	1 1/4" x 3/4" x 1 1/4"	15	210	255
13143	1 1/4" x 1" x 1 1/4"	15	210	225
13144	1 1/4" x 1 1/4" x 1 1/4"	15	180	210
13155	1 1/2" x 1 1/2" x 1 1/2"	10	100	110
13165	2" x 1 1/2" x 2"	6	66	72
13166	2" x 2" x 2"	6	60	72
13177	2 1/2" x 2 1/2" x 2 1/2"	3	36	39
13188	3" x 3" x 3"	2	22	26
13199	4" x 4" x 4"	1	15	15

KOD CODE	EBAT / SIZE G x G, x G	AMBALAJ ADEDİ PACKING QUANTITY	KOLİ ADEDİ BOX QUANTITY	ÇUVAL ADEDİ SACK QUANTITY
13211	1/2" x 1/2" x 1/2"	25	550	600
13212	1/2" x 3/4" x 1/2"	25	500	550
13221	3/4" x 1/2" x 3/4"	25	500	550
13222	3/4" x 3/4" x 3/4"	25	450	450
13223	3/4" x 1" x 3/4"	25	375	400
13231	1" x 1/2" x 1"	25	400	400
13232	1" x 3/4" x 1"	25	350	400
13233	1" x 1" x 1"	25	300	350
13242	1 1/4" x 3/4" x 1 1/4"	15	195	225
13243	1 1/4" x 1" x 1 1/4"	15	180	210
13254	1 1/2" x 1 1/4" x 1 1/2"	10	110	120
13255	1 1/2" x 1 1/2" x 1 1/2"	10	80	100
13264	2" x 1 1/4" x 2"	6	60	72
13265	2" x 1 1/2" x 2"	6	60	72
13266	2" x 2" x 2"	6	48	60
13267	2 1/2" x 2 1/2" x 2 1/2"	3	30	36
13268	3" x 3" x 3"	2	18	24
13269	4" x 4" x 4"	1	14	13

KOD CODE	EBAT / SIZE G x G x G	AMBALAJ ADEDİ PACKING QUANTITY	KOLİ ADEDİ BOX QUANTITY	ÇUVAL ADEDİ SACK QUANTITY
13271	1/2" x 1/2" x 1/2"	25	450	450
13272	3/4" x 3/4" x 3/4"	25	275	300
13273	1" x 1" x 1"	25	200	225
13274	1 1/4" x 1 1/4" x 1 1/4"	15	105	120
13275	1 1/2" x 1 1/2" x 1 1/2"	10	60	80
13276	2" x 2" x 2"	6	42	48
13277	2 1/2" x 2 1/2" x 2 1/2"	3	27	27
13278	3" x 3" x 3"	2	18	20
13279	4" x 4" x 4"	1	12	12

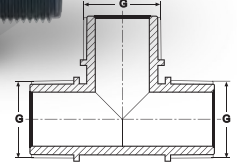

DIŞLİ TE ERKEK - ERKEK - ERKEK

THREADED TEE MALE - MALE - MALE
ТРОЙНИК НАРУЖНАЯ РЕЗЬБА
НАРУЖНАЯ РЕЗЬБА - НАРУЖНАЯ РЕЗЬБА
تقسيم مسنن سن خارج-خارج-خارج

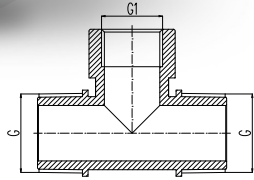

DIŞLİ TE ERKEK - DIŞİ - ERKEK

THREADED TEE MALE - FEMALE - MALE
ТРОЙНИК НАРУЖНАЯ РЕЗЬБА
ВНУТРЕННЯЯ РЕЗЬБА - НАРУЖНАЯ РЕЗЬБА
تقسيم مسنن سن خارج-داخل-خارج

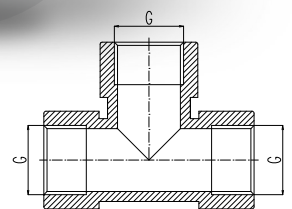
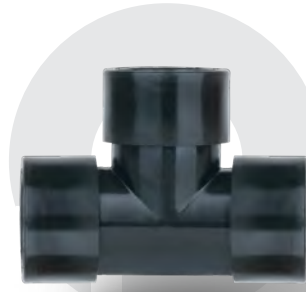

DIŞLİ TE DIŞİ - DIŞİ - DIŞİ

THREADED TEE FEMALE - FEMALE - FEMALE
ТРОЙНИК ВНУТРЕННЯЯ РЕЗЬБА
ВНУТРЕННЯЯ РЕЗЬБА - ВНУТРЕННЯЯ РЕЗЬБА
تقسيم مسنن سن داخل-داخل-داخل

DIŞLİ BAĞLANTI ELEMANLARI / THREADED FITTINGS

مواد الربط المسننة / РЕЗЬБОВЫЕ ФИТИНГИ

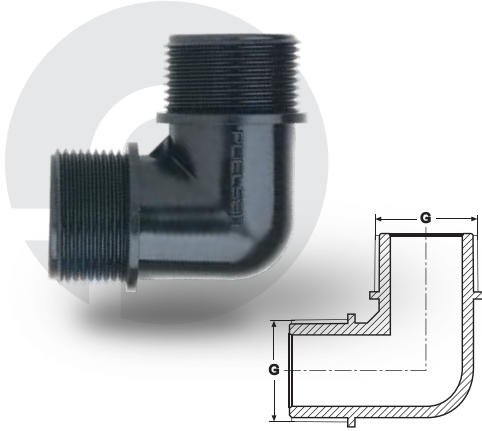

DIŞLİ DİRSEK ERKEK - ERKEK

THREADED ELBOW MALE - MALE

УГОЛ НАРУЖНАЯ РЕЗЬБА - НАРУЖНАЯ РЕЗЬБА

عكس مسنن سن خارج-خارج

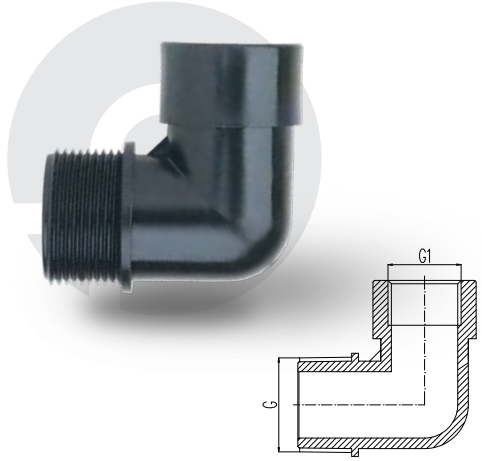

DIŞLİ DİRSEK ERKEK - DIŞI

THREADED ELBOW MALE - FEMALE

УГОЛ НАРУЖНАЯ РЕЗЬБА - ВНУТРЕННЯЯ РЕЗЬБА

عكس مسنن سن خارج-داخل

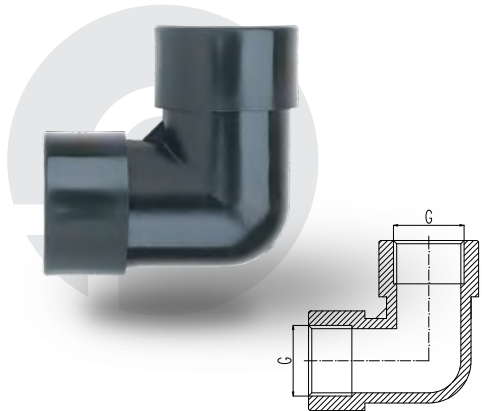

DIŞLİ DİRSEK DIŞI - DIŞI

THREADED ELBOW FEMALE - FEMALE

УГОЛ ВНУТРЕННЯЯ РЕЗЬБА - ВНУТРЕННЯЯ РЕЗЬБА

عكس مسنن سن داخل-داخل

KOD CODE	EBAT / SIZE G x G	AMBALAJ ADEDİ PACKING QUANTITY	KOLİ ADEDİ BOX QUANTITY	ÇUVAL ADEDİ SACK QUANTITY
13311	1/2" x 1/2"	25	900	950
13321	3/4" x 1/2"	25	900	950
13322	3/4" x 3/4"	25	800	900
13331	1" x 1/2"	25	600	625
13332	1" x 3/4"	25	600	650
13333	1" x 1"	25	550	550
13341	1 1/4" x 1/2"	15	300	345
13342	1 1/4" x 3/4"	15	300	360
13343	1 1/4" x 1"	15	300	330
13344	1 1/4" x 1 1/4"	15	240	270
13355	1 1/2" x 1 1/2"	10	150	180
13364	2" x 1 1/4"	6	108	120
13365	2" x 1 1/2"	6	108	126
13366	2" x 2"	6	90	102
13377	2 1/2" x 2 1/2"	4	56	60
13388	3" x 3"	2	36	40
13399	4" x 4"	1	23	24

KOD CODE	EBAT / SIZE G x G _i	AMBALAJ ADEDİ PACKING QUANTITY	KOLİ ADEDİ BOX QUANTITY	ÇUVAL ADEDİ SACK QUANTITY
13411	1/2" x 1/2"	25	800	750
13412	1/2" x 3/4"	25	600	600
13421	3/4" x 1/2"	25	700	625
13422	3/4" x 3/4"	25	600	600
13423	3/4" x 1"	25	500	550
13431	1" x 1/2"	25	550	550
13432	1" x 3/4"	25	500	500
13433	1" x 1"	25	400	450
13442	1 1/4" x 3/4"	15	270	300
13443	1 1/4" x 1"	15	240	270
13444	1 1/4" x 1 1/4"	15	210	210
13454	1 1/2" x 1 1/4"	10	140	170
13455	1 1/2" x 1 1/2"	10	120	140
13464	2" x 1 1/4"	6	108	120
13465	2" x 1 1/2"	6	84	108
13466	2" x 2"	6	72	84
13467	2 1/2" x 2 1/2"	4	48	48
13468	3" x 3"	2	32	30
13469	4" x 4"	1	18	20

KOD CODE	EBAT / SIZE G x G	AMBALAJ ADEDİ PACKING QUANTITY	KOLİ ADEDİ BOX QUANTITY	ÇUVAL ADEDİ SACK QUANTITY
13471	1/2" x 1/2"	25	800	800
13472	3/4" x 3/4"	25	450	500
13473	1" x 1"	25	300	350
13474	1 1/4" x 1 1/4"	15	180	195
13475	1 1/2" x 1 1/2"	10	110	120
13476	2" x 2"	6	66	72
13477	2 1/2" x 2 1/2"	4	36	48
13478	3" x 3"	2	26	28
13479	4" x 4"	1	16	18
13480	1 1/2" x 1 1/4"	10	120	150

DIŞLİ BAĞLANTI ELEMANLARI / THREADED FITTINGS

مواد الربط المسننة / РЕЗЬБОВЫЕ ФИТИНГИ

KOD CODE	EBAT / SIZE G x G	AMBALAJ ADEDİ PACKING QUANTITY	KOLİ ADEDİ BOX QUANTITY	ÇUVAL ADEDİ SACK QUANTITY
13511	½" x ½"	50	1500	1600
13522	¾" x ¾"	50	1400	1400
13533	1" x 1"	50	900	900
13544	1 ¼" x 1 ¼"	25	375	400
13555	1 ½" x 1 ½"	25	250	300
13566	2" x 2"	25	150	175
13577	2 ½" x 2 ½"	12	96	108
13588	3" x 3"	12	60	72
13599	4" x 4"	6	36	48

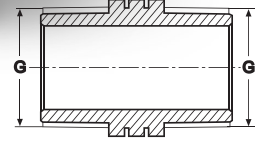
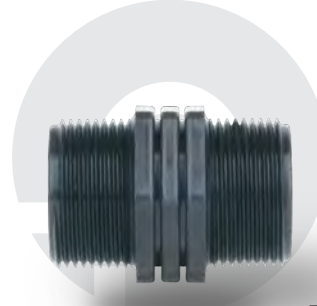

DIŞLİ NİPEL
THREADED NIPPLE
НИППЕЛЬ РЕЗЬБОВОЙ
زبانه مسننه

KOD CODE	EBAT / SIZE G ₁ x G	AMBALAJ ADEDİ PACKING QUANTITY	KOLİ ADEDİ BOX QUANTITY	ÇUVAL ADEDİ SACK QUANTITY
13621	¾" x ½"	50	1500	1500
13631	1" x ½"	50	1000	1050
13632	1" x ¾"	50	900	1000
13641	1 ¼" x ½"	25	450	500
13642	1 ¼" x ¾"	25	450	500
13643	1 ¼" x 1"	25	450	500
13652	1 ½" x ¾"	25	300	300
13653	1 ½" x 1"	25	300	350
13654	1 ½" x 1 ¼"	25	275	300
13663	2" x 1"	25	200	225
13664	2" x 1 ¼"	25	175	225
13665	2" x 1 ½"	25	175	200
13674	2 ½" x 1 ¼"	12	120	132
13675	2 ½" x 1 ½"	12	108	120
13676	2 ½" x 2"	12	108	120
13685	3" x 1 ½"	12	96	120
13686	3" x 2"	12	96	120
13687	3" x 2 ½"	12	72	84
13696	4" x 2"	6	60	60
13697	4" x 2 ½"	6	60	60
13698	4" x 3"	6	60	60

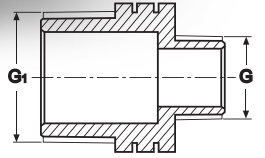

DIŞLİ REDÜKSİYON NİPEL
THREADED REDUCING NIPPLE
НИППЕЛЬ РЕЗЬБОВОЙ ПЕРЕХОДНЫЙ
زبانه مسننه مصغرة

KOD CODE	EBAT / SIZE G x G	AMBALAJ ADEDİ PACKING QUANTITY	KOLİ ADEDİ BOX QUANTITY	ÇUVAL ADEDİ SACK QUANTITY
13711	½" x ½"	50	1200	1250
13722	¾" x ¾"	50	750	900
13733	1" x 1"	50	400	450
13744	1 ¼" x 1 ¼"	25	250	300
13755	1 ½" x 1 ½"	15	225	240
13766	2" x 2"	12	144	156
13777	2 ½" x 2 ½"	12	120	108
13788	3" x 3"	6	60	78
13799	4" x 4"	4	40	40

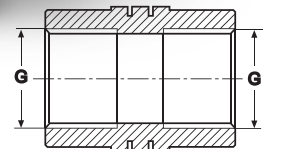

DIŞLİ MANŞON
THREADED COUPLING
МУФТА РЕЗЬБОВАЯ
صمونه مسننه

DIŞLİ BAĞLANTI ELEMANLARI / THREADED FITTINGS

مواد الربط المسننة / РЕЗЬБОВЫЕ ФИТИНГИ

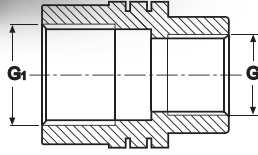

DIŞLİ REDÜKSİYON MANŞON

THREADED REDUCING COUPLING
МУФТА РЕЗЬБОВАЯ ПЕРЕХОДНАЯ
صمونة مسننة مصغرة

KOD CODE	EBAT / SIZE G ₁ x G	AMBALAJ ADEDİ PACKING QUANTITY	KOLİ ADEDİ BOX QUANTITY	ÇUVAL ADEDİ SACK QUANTITY
13821	¾" x ½"	50	800	850
13831	1" x ½"	50	450	550
13832	1" x ¾"	50	400	550
13842	1 ¼" x ¾"	25	300	300
13843	1 ¼" x 1"	25	275	325
13853	1 ½" x 1"	15	270	270
13854	1 ½" x 1 ¼"	15	240	270
13864	2" x 1 ¼"	12	192	204
13865	2" x 1 ½"	12	168	180
13874	2 ½" x 1 ¼"	12	168	156
13875	2 ½" x 1 ½"	12	168	144
13876	2 ½" x 2"	12	120	120
13886	3" x 2"	6	84	90
13887	3" x 2 ½"	6	72	84
13896	4" x 2"	6	56	48
13897	4" x 2 ½"	4	48	48
13898	4" x 3"	4	48	44

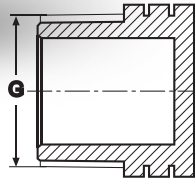
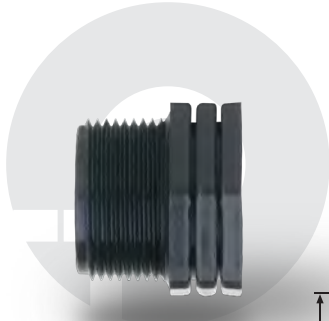

DIŞLİ KÖR TAPA ERKEK

THREADED END CAP MALE
ЗАГЛУШКА С НАРУЖНОЙ РЕЗЬБОЙ
سدادة سن خارج مسننة

KOD CODE	EBAT / SIZE G	AMBALAJ ADEDİ PACKING QUANTITY	KOLİ ADEDİ BOX QUANTITY	ÇUVAL ADEDİ SACK QUANTITY
14111	½"	50	2000	2000
14122	¾"	50	1800	1800
14133	1"	50	1200	1300
14144	1 ¼"	25	550	600
14155	1 ½"	15	360	390
14166	2"	12	240	264
14177	2 ½"	12	144	168
14188	3"	6	120	108
14199	4"	4	56	64

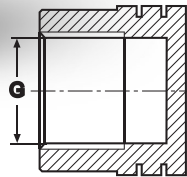

DIŞLİ KÖR TAPA DIŞİ

THREADED END CAP FEMALE
ЗАГЛУШКА С ВНУТРЕННЕЙ РЕЗЬБОЙ
سدادة سن داخل مسننة

KOD CODE	EBAT / SIZE G	AMBALAJ ADEDİ PACKING QUANTITY	KOLİ ADEDİ BOX QUANTITY	ÇUVAL ADEDİ SACK QUANTITY
14211	½"	50	1600	1500
14222	¾"	50	1100	1150
14233	1"	50	600	650

DIŞLİ BAĞLANTI ELEMANLARI / THREADED FITTINGS

مواد الربط المسننة / РЕЗЬБОВЫЕ ФИТИНГИ

KOD CODE	EBAT / SIZE G x G ₁	AMBALAJ ADEDİ PACKING QUANTITY	KOLİ ADEDİ BOX QUANTITY	ÇUVAL ADEDİ SACK QUANTITY
13911	½" x ½"	50	1300	1300
13912	½" x ¾"	50	900	1050
13913	½" x 1"	50	500	550
13922	¾" x ¾"	50	800	900
13923	¾" x 1"	50	500	550
13933	1" x 1"	50	450	500
13944	1 ¼" x 1 ¼"	15	210	255
13945	1 ¼" x 1 ½"	15	270	285
13954	1 ½" x 1 ¼"	15	300	300
13955	1 ½" x 1 ½"	15	210	255
13956	1 ½" x 2"	15	180	210
13957	1 ½" x 2 ½"	15	120	135
13966	2" x 2"	15	150	180
13967	2" x 2 ½"	12	108	132
13968	2" x 3"	6	84	84
13969	2" x 4"	4	56	48
13977	2 ½" x 2 ½"	12	84	108
13978	2 ½" x 3"	6	72	84
13979	2 ½" x 4"	4	48	48
13988	3" x 3"	6	66	72
13989	3" x 4"	4	48	44
13999	4" x 4"	4	40	36



DIŞLİ REDÜKSİYON ERKEK - DIŞI
THREADED REDUCING MALE - FEMALE
ПЕРЕХОДНАЯ МУФТА НАРУЖНАЯ РЕЗЬБА - ВНУТРЕННЯЯ РЕЗЬБА
مصغرة سن خارج - سن داخل مسننة

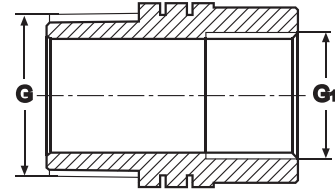

KOD CODE	EBAT / SIZE G x G ₁	AMBALAJ ADEDİ PACKING QUANTITY	KOLİ ADEDİ BOX QUANTITY	ÇUVAL ADEDİ SACK QUANTITY
13921	¾" x ½"	50	1900	2000
13931	1" x ½"	50	1200	1250
13932	1" x ¾"	50	1200	1300
13941	1 ¼" x ½"	25	550	600
13942	1 ¼" x ¾"	25	550	600
13943	1 ¼" x 1"	25	550	600
13951	1 ½" x ½"	15	390	390
13952	1 ½" x ¾"	15	360	390
13953	1 ½" x 1"	15	360	390
13961	2" x ½"	15	270	270
13962	2" x ¾"	15	255	270
13963	2" x 1"	15	240	270
13964	2" x 1 ¼"	15	255	270
13965	2" x 1 ½"	15	255	270
13973	2 ½" x 1"	12	144	144
13974	2 ½" x 1 ¼"	12	144	168
13975	2 ½" x 1 ½"	12	144	168
13976	2 ½" x 2"	12	144	168
13984	3" x 1 ¼"	12	96	108
13985	3" x 1 ½"	12	96	108
13986	3" x 2"	12	96	108
13987	3" x 2 ½"	12	96	120
13996	4" x 2"	6	60	60
13997	4" x 2 ½"	6	60	72
13998	4" x 3"	6	60	72

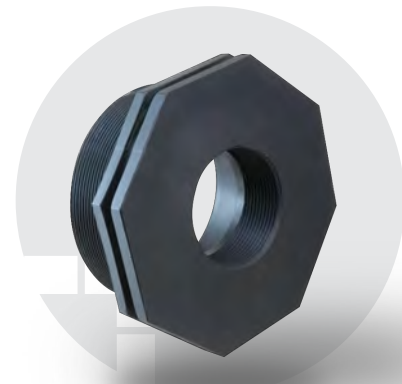

DIŞLİ REDÜKSİYON ERKEK - DIŞI
THREADED REDUCING MALE - FEMALE
BUSHING
ПЕРЕХОДНИК РЕЗЬБОВОЙ «МУФТА»
بوش مصغرة مسننة سن خارج - سن داخل

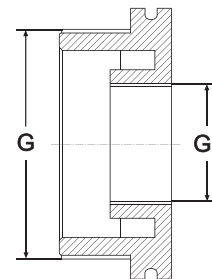

DIŞLİ BAĞLANTI ELEMANLARI / THREADED FITTINGS

مواد الربط المسننة / РЕЗЬБОВЫЕ ФИТИНГИ



MTT-100 KOLLEKTÖR TE

MTT-100 MANIFOLD TEE
Коллекторный тройник мтт-100
قسام تجميع 1 بوصة

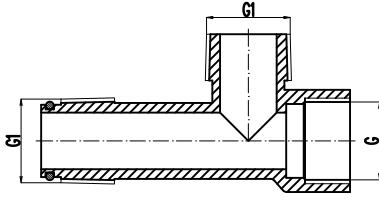

KOD CODE	EBAT / SIZE G, x G, x G	AMBALAJ ADEDİ PACKING QUANTITY	KOLİ ADEDİ BOX QUANTITY	ÇUVAL ADEDİ SACK QUANTITY
14333	1" x 1" x 1"	6	270	300

DIŞLİ BAĞLANTI ELEMANLARI

THREADED FITTINGS
РЕЗЬБОВЫЕ ФИТИНГИ
مواد الربط المسننة

DİKKAT EDİLMESİ GEREKEN HUSUSLAR

- + Ürünlerde dış kısımlarına sızdırmazlık için teflon vb. sızdırmazlık elemanı kullanılmalıdır.
- + Ürünler dış bitiminden sonra aşırı zorlanmamalıdır.

POINTS TO TAKE INTO CONSIDERATION

- + Sealing elements such as Teflon should be used to seal the threads of the products.
- + Products should not be forced after thread end.

KİLİTLİ BAĞLANTI ELEMANLARI

LOCK TYPE FITTINGS
ЗАЖИМНЫЕ ФИТИНГИ
مواد الري نوعية اقفال

Özellikler

- + Darbelere karşı dayanıklı, yüksek kaliteli polipropilèn hammaddeden üretilmiştir.
- + UV ışınlarını geçirmediği için yosunlanmaya ve bakteri üremesine izin vermez.
- + İç yüzeyleri homojen ve gözeneksizdir.
- + Suyun kokusunu ve tadını değiştirebilecek zararlı bileşikler içermez.

Specifications

- + It has been produced from high quality polypropylene raw material and it has resistance to impact.
- + They prevent alga and bacteria forming due to UV proof (ultraviolet beam) structure.
- + It has a homogeneous and non-porous inner surface.
- + It does not contain any harmful compounds which can change the taste or the smell of the water.

GARANTİ VERİLEN BASINÇ DEĞERİ : PN 6
GUARANTEED PRESSURE VALUE : PN 6



TS EN ISO 9261

KULLANIM ALANLARI

- + Peyzaj Sektörü
- + Tarımsal Sulama
- + Seralar

INSTALLATION AREAS

- + Landscaping Systems
- + Agricultural Irrigation
- + Greenhouses



KİLİTLİ BAĞLANTI ELEMANLARI / LOCK TYPE FITTINGS

مواد الري نوعية اقفال / ЗАЖИМНЫЕ ФИТИНГИ



KİLİTLİ BAĞLANTI ERKEK

LOCK TYPE MALE

ЗАЖИМНОЙ ФИТИНГ С НАРУЖНОЙ РЕЗЬБОЙ
نوعية اقفال سن خارج

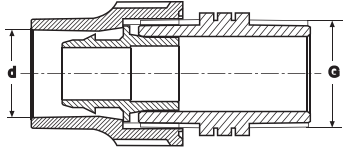

KOD CODE	EBAT / SIZE d x G	AMBALAJ ADEDİ PACKING QUANTITY	KOLİ ADEDİ BOX QUANTITY	ÇUVAL ADEDİ SACK QUANTITY
12121	16 x ½"	50	900	900
12122	16 x ¾"	50	800	900
12123	16 x 1"	50	650	700
12124	16 x 1 ¼"	50	350	500
12141	20 x ½"	50	700	900
12142	20 x ¾"	50	700	800
12143	20 x 1"	50	600	700
12144	20 x 1 ¼"	50	350	400
12151	25 x ½"	25	450	500
12152	25 x ¾"	25	450	525
12153	25 x 1"	25	450	450
12154	25 x 1 ¼"	25	300	300
12161	32 x ½"	25	275	250
12162	32 x ¾"	25	275	300
12163	32 x 1"	25	250	300
12164	32 x 1 ¼"	25	225	250



KİLİTLİ BAĞLANTI DIŞI

LOCK TYPE FEMALE

ЗАЖИМНОЙ ФИТИНГ С ВНУТРЕННЕЙ РЕЗЬБОЙ
نوعية اقفال سن داخل

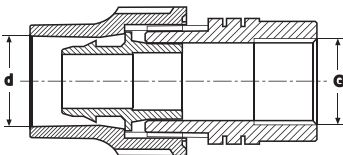

KOD CODE	EBAT / SIZE d x G	AMBALAJ ADEDİ PACKING QUANTITY	KOLİ ADEDİ BOX QUANTITY	ÇUVAL ADEDİ SACK QUANTITY
12221	16 x ½"	50	900	1000
12222	16 x ¾"	50	650	650
12223	16 x 1"	50	400	450
12241	20 x ½"	50	900	1000
12242	20 x ¾"	50	550	600
12243	20 x 1"	50	400	400
12251	25 x ½"	25	450	400
12252	25 x ¾"	25	400	550
12253	25 x 1"	25	300	375
12261	32 x ½"	25	275	275
12262	32 x ¾"	25	250	250
12263	32 x 1"	25	225	275

KİLİTLİ BAĞLANTI ELEMANLARI / LOCK TYPE FITTINGS

KOD CODE	EBAT / SIZE d x d	AMBALAJ ADEDİ PACKING QUANTITY	KOLİ ADEDİ BOX QUANTITY	ÇUVAL ADEDİ SACK QUANTITY
12322	16 x 16	50	550	600
12342	20 x 16	50	500	600
12344	20 x 20	50	500	550
12352	25 x 16	25	350	400
12354	25 x 20	25	350	400
12355	25 x 25	25	300	350
12362	32 x 16	15	210	240
12364	32 x 20	15	210	255
12365	32 x 25	15	210	225
12366	32 x 32	15	165	195



KİLİTLİ BAĞLANTI MANŞON

LOCK TYPE COUPLING
ЗАЖИМНОЙ ФИТИНГ МУФТА
نوعية اقفال رباطة

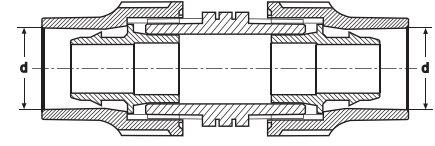

مواد الري نوعية اقفال/ ЗАЖИМНЫЕ ФИТИНГИ

KOD CODE	EBAT / SIZE d x d x d	AMBALAJ ADEDİ PACKING QUANTITY	KOLİ ADEDİ BOX QUANTITY	ÇUVAL ADEDİ SACK QUANTITY
12422	16 x 16 x 16	25	300	300
12424	16 x 20 x 16	25	275	300
12425	16 x 25 x 16	25	200	250
12442	20 x 16 x 20	25	275	300
12444	20 x 20 x 20	25	275	300
12445	20 x 25 x 20	25	225	250
12452	25 x 16 x 25	15	180	180
12454	25 x 20 x 25	15	165	210
12455	25 x 25 x 25	15	150	180
12462	32 x 16 x 32	10	100	100
12464	32 x 20 x 32	10	100	120
12465	32 x 25 x 32	10	100	110
12466	32 x 32 x 32	10	90	100



KİLİTLİ BAĞLANTI TE

LOCK TYPE TEE
ЗАЖИМНОЙ ФИТИНГ ТРОЙНИК
نوعية اقفال تقسيم

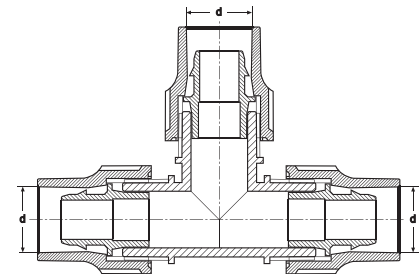

KİLİTLİ BAĞLANTI ELEMANLARI / LOCK TYPE FITTINGS

مواد الري نوعية اقفال/ЗАЖИМНЫЕ ФИТИНГИ



KİLİTLİ BAĞLANTI ERKEK TE

LOCK TYPE MALE TEE

ЗАЖИМНОЙ ФИТИНГ ТРОЙНИК С НАРУЖНОЙ РЕЗЬБОЙ
نوعية اقفال تقسيم سن خارج

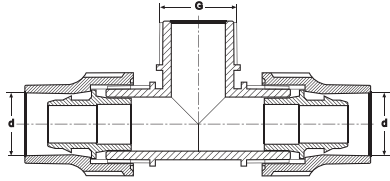

KOD CODE	EBAT / SIZE d x G x d	AMBALAJ ADEDİ PACKING QUANTITY	KOLİ ADEDİ BOX QUANTITY	ÇUVAL ADEDİ SACK QUANTITY
12521	16 x 1/2" x 16	25	350	425
12522	16 x 3/4" x 16	25	350	400
12523	16 x 1" x 16	25	300	350
12541	20 x 1/2" x 20	25	350	375
12542	20 x 3/4" x 20	25	300	300
12543	20 x 1" x 20	25	300	350
12551	25 x 1/2" x 25	15	210	240
12552	25 x 3/4" x 25	15	210	225
12553	25 x 1" x 25	15	210	240
12561	32 x 1/2" x 32	10	120	140
12562	32 x 3/4" x 32	10	110	130
12563	32 x 1" x 32	10	110	120
12564	32 x 1 1/4" x 32	10	100	120

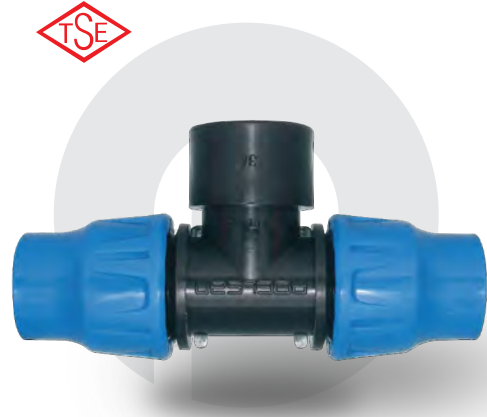

KİLİTLİ BAĞLANTI DIŞI TE

LOCK TYPE FEMALE TEE

ЗАЖИМНОЙ ФИТИНГ ТРОЙНИК С ВНУТРЕННЕЙ РЕЗЬБОЙ
نوعية اقفال تقسيم سن داخل

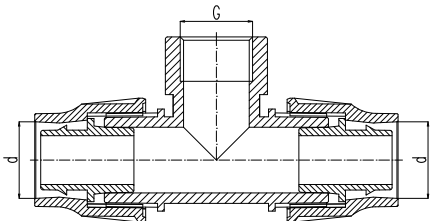

KOD CODE	EBAT / SIZE d x G x d	AMBALAJ ADEDİ PACKING QUANTITY	KOLİ ADEDİ BOX QUANTITY	ÇUVAL ADEDİ SACK QUANTITY
12621	16 x 1/2" x 16	25	300	350
12622	16 x 3/4" x 16	25	300	325
12623	16 x 1" x 16	25	275	275
12641	20 x 1/2" x 20	25	300	325
12642	20 x 3/4" x 20	25	275	300
12643	20 x 1" x 20	25	250	250
12651	25 x 1/2" x 25	15	210	225
12652	25 x 3/4" x 25	15	180	195
12653	25 x 1" x 25	15	165	180
12662	32 x 3/4" x 32	10	120	120
12663	32 x 1" x 32	10	100	120

KİLİTLİ BAĞLANTI ELEMANLARI / LOCK TYPE FITTINGS

KOD CODE	EBAT / SIZE d x d	AMBALAJ ADEDİ PACKING QUANTITY	KOLİ ADEDİ BOX QUANTITY	ÇUVAL ADEDİ SACK QUANTITY
12722	16 x 16	50	450	500
12742	20 x 16	50	450	450
12744	20 x 20	50	400	450
12752	25 x 16	25	300	300
12754	25 x 20	25	300	375
12755	25 x 25	25	225	250
12762	32 x 16	15	180	225
12764	32 x 20	15	180	210
12765	32 x 25	15	165	180
12766	32 x 32	15	135	150



KİLİTLİ BAĞLANTI DİRSEK

LOCK TYPE ELBOW
ЗАЖИМНОЙ ФИТИНГ УГОЛ
نوعية اقفال عكس

مواد الري نوعية اقفال / ЗАЖИМНЫЕ ФИТИНГИ

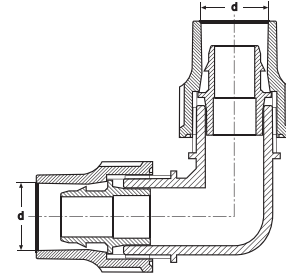

KOD CODE	EBAT / SIZE d x G	AMBALAJ ADEDİ PACKING QUANTITY	KOLİ ADEDİ BOX QUANTITY	ÇUVAL ADEDİ SACK QUANTITY
12821	16 x 1/2"	50	600	700
12822	16 x 3/4"	50	600	700
12823	16 x 1"	50	500	500
12824	16 x 1 1/4"	50	300	400
12841	20 x 1/2"	50	600	700
12842	20 x 3/4"	50	600	600
12843	20 x 1"	50	500	550
12844	20 x 1 1/4"	50	300	250
12851	25 x 1/2"	25	375	400
12852	25 x 3/4"	25	400	450
12853	25 x 1"	25	325	350
12854	25 x 1 1/4"	25	225	275
12861	32 x 1/2"	15	210	210
12862	32 x 3/4"	15	180	225
12863	32 x 1"	15	210	240
12864	32 x 1 1/4"	15	180	210



KİLİTLİ BAĞLANTI ERKEK DİRSEK

LOCK TYPE MALE ELBOW
ЗАЖИМНОЙ ФИТИНГ УГОЛ С НАРУЖНОЙ РЕЗЬБОЙ
نوعية اقفال عكس سن خارج

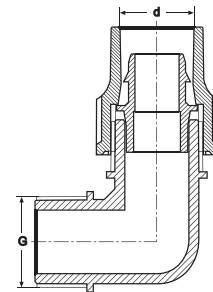

KİLİTLİ BAĞLANTI ELEMANLARI / LOCK TYPE FITTINGS

مواد الري نوعية اففال / ЗАЖИМНЫЕ ФИТИНГИ



KİLİTLİ BAĞLANTI DIŞI DİRSEK

LOCK TYPE FEMALE ELBOW

ЗАЖИМНОЙ ФИТИНГ УГОЛ С ВНУТРЕННЕЙ РЕЗЬБОЙ

نوعية اففال عكس سن داخل

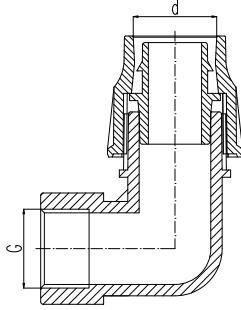

KOD CODE	EBAT / SIZE d x G	AMBALAJ ADEDİ PACKING QUANTITY	KOLİ ADEDİ BOX QUANTITY	ÇUVAL ADEDİ SACK QUANTITY
12921	16 x 1/2"	50	500	600
12922	16 x 3/4"	50	450	500
12923	16 x 1"	50	400	500
12941	20 x 1/2"	50	500	600
12942	20 x 3/4"	50	450	500
12943	20 x 1"	50	400	450
12951	25 x 1/2"	25	300	350
12952	25 x 3/4"	25	300	300
12953	25 x 1"	25	275	300
12962	32 x 3/4"	15	180	180
12963	32 x 1"	15	180	210
12964	32 x 1 1/4"	15	150	180



KİLİTLİ BAĞLANTI KÖR TAPA

LOCK TYPE END CAP

ЗАЖИМНОЙ ФИТИНГ ЗАГЛУШКА

نوعية اففال سدادة

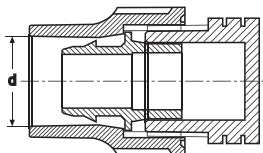

KOD CODE	EBAT / SIZE d	AMBALAJ ADEDİ PACKING QUANTITY	KOLİ ADEDİ BOX QUANTITY	ÇUVAL ADEDİ SACK QUANTITY
13022	16	50	900	1000
13044	20	50	900	1000
13055	25	25	550	600
13066	32	25	300	350

KİLİTLİ BAĞLANTI ELEMANLARI / LOCK TYPE FITTINGS

KOD CODE	EBAT / SIZE d x d ₁	AMBALAJ ADEDİ PACKING QUANTITY	KOLİ ADEDİ BOX QUANTITY	ÇUVAL ADEDİ SACK QUANTITY
130922	16 x 16	50	900	1000
130942	20 x 16	50	800	1000
130944	20 x 20	50	700	700



KİLİTLİ BAĞLANTI KURTAĞZI

LOCK TYPE BARBED
ЗАЖИМНОЙ ФИТИНГ ЁРШ
نوعية اففال شائكة

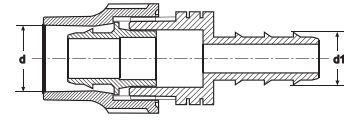

مواد الري نوعية اففال / ЗАЖИМНЫЕ ФИТИНГИ

KOD CODE	EBAT / SIZE d	GÖVDE EBADI BODY SIZE	AMBALAJ ADEDİ PACKING QUANTITY	KOLİ ADEDİ BOX QUANTITY	ÇUVAL ADEDİ SACK QUANTITY
13072	16	¾"	100	1800	1500
13074	20	¾"	100	1500	1600
13075	25	1"	50	800	1250
13076	32	1¼"	50	450	400



KİLİTLİ BAĞLANTI SOMONU

LOCK TYPE NUT
ЗАЖИМНАЯ НАКИДНАЯ ГАЙКА
نوعية اففال صمونة

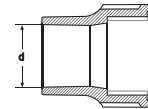

KOD CODE	EBAT / SIZE d	GÖVDE EBADI BODY SIZE	AMBALAJ ADEDİ PACKING QUANTITY	KOLİ ADEDİ BOX QUANTITY	ÇUVAL ADEDİ SACK QUANTITY
13082	16	¾"	200	5200	6000
13084	20	¾"	200	4800	4400
13085	25	1"	100	2400	3000
13086	32	1¼"	100	1200	1300



KİLİTLİ BAĞLANTI UCU

LOCK TYPE INSERT
ЗАЖИМНОЙ СОЕДИНИТЕЛЬНЫЙ ФИТИНГ
نوعية اففال ادخال

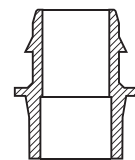

KİLİTLİ BAĞLANTI ELEMANLARI

LOCK TYPE FITTINGS
ЗАЖИМНЫЕ ФИТИНГИ
مواد الري نوعية اقفال

DİKKAT EDİLMESİ GEREKEN HUSUSLAR

- + Ø16 mm, Ø20 mm, Ø25 mm, Ø32 mm Alçak Yoğunluklu Polietilen (AYPE) Borularda (Deliksiz kör boru) kullanılır.
- + Ø16 mm için et kalınlığı minimum 0.8 mm'ye kadar ve Ø20 mm için et kalınlığı minimum 1.0 mm'ye kadar olan Yuvarlak Damla Sulama Borularında da kullanılabilir.
- + Ø16 mm, Ø20 mm, Ø25 mm, Ø 32 mm olan PVC Bahçe Sulama Hortumlarının Ekleme Parçaları olarak da kullanılabilir.

POINTS TO TAKE INTO CONSIDERATION

- + Used in Ø16 mm, Ø20 mm, Ø25 mm, Ø32 mm Low Density Polyethylene (LDPE) Pipes (Flat Drip Irrigation Pipe).
- + Also might be used with Round Drip Irrigation Pipe with Ø16 mm diameter up to 0.8 mm of wall thickness and Ø20 mm diameter with 1.0 mm of wall thickness.
- + Also might be used as Fittings for Ø16 mm, Ø20 mm, Ø25 mm, Ø32 mm Garden Hoses made of PVC.

MINİ VANALAR (DN 8)

MINI VALVES
МИНИ КРАНЫ
اقفال الصغيرة

Özellikler

- + Su geçiş çapı 8 mm.
- + Darbelere karşı dayanıklı, yüksek kaliteli polipropilen hammaddeden üretilmiştir.
- + Sulama sisteminizi kolayca açıp kapayarak kontrol etmenizi sağlar.
- + UV ışınlarını geçirmediği için yosunlanmaya ve bakteri üremesine izin vermez.
- + Oringi kauçuktan üretilmekte olup yüksek basınç altında sızdırmazlık sağlar.
- + İç yüzeyleri homojen ve gözeneksizdir.
- + Suyun kokusunu ve tadını değiştirebilecek zararlı bileşikler içermez.

Specifications

- + Water pass diameter 8 mm.
- + It has been produced from high quality polypropylene raw material and it has resistance to impact.
- + It supplies an easy on-off control on the irrigation system.
- + They prevent alga and bacteria forming due to UV proof (ultraviolet beam) structure.
- + O-rings are made of rubber and provide leakproofness under high pressure.
- + It has a homogeneous and non-porous inner surface.
- + It does not contain any harmful compounds which can change the taste or the smell of the water.



TS EN ISO 9261

GARANTİ VERİLEN BASINÇ DEĞERİ : PN 4
GUARANTEED PRESSURE VALUE : PN 4



KULLANIM ALANLARI

- + Tarımsal Sulama
- + Peyzaj Sektörü
- + Seralar

INSTALLATION AREAS

- + Agricultural Irrigation
- + Landscaping Systems
- + Greenhouses

DAMLA SULAMA MİNİ VANALAR (DN 8) / DRIPLINE MINI VALVES (DN 8)

صمام صغير لخط التنقيط / МИНИ-КРАНЫ ДЛЯ КАПЕЛЬНОГО ОРОШЕНИЯ



MİNİ VANA KİLİTLİ BAĞLANTI

MINI VALVE LOCK TYPE
МИНИ КРАН С ЗАМКОМ
اقفال الصغيرة نوعية اقفال

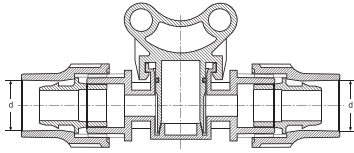

KOD CODE	EBAT / SIZE d x d	AMBALAJ ADEDİ PACKING QUANTITY	KOLİ ADEDİ BOX QUANTITY	ÇUVAL ADEDİ SACK QUANTITY
11122	16 x 16	50	350	400
11142	20 x 16	50	300	400
11144	20 x 20	50	300	350



MİNİ VANA KİLİTLİ BAĞLANTI - ERKEK

MINI VALVE LOCK TYPE - MALE
МИНИ КРАН С ЗАМКОМ - НАРУЖНАЯ РЕЗЬБА
اقفال الصغيرة نوعية اقفال- سن خارج

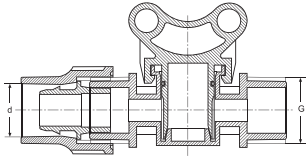

KOD CODE	EBAT / SIZE d x G	AMBALAJ ADEDİ PACKING QUANTITY	KOLİ ADEDİ BOX QUANTITY	ÇUVAL ADEDİ SACK QUANTITY
11221	16 x 1/2"	50	500	500
11222	16 x 3/4"	50	450	500
11241	20 x 1/2"	50	450	500
11242	20 x 3/4"	50	400	450



MİNİ VANA ERKEK

MINI VALVE MALE
МИНИ-КРАН «ШТУЦЕР»
قفل صغير - سن خارج

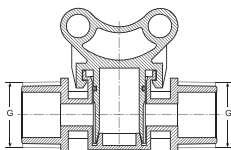

KOD CODE	EBAT / SIZE G x G	AMBALAJ ADEDİ PACKING QUANTITY	KOLİ ADEDİ BOX QUANTITY	ÇUVAL ADEDİ SACK QUANTITY
11311	1/2" x 1/2"	50	700	800
11321	3/4" x 1/2"	50	650	750
11322	3/4" x 3/4"	50	600	600

DAMLA SULAMA MİNİ VANALAR (DN 8) / DRIPLINE MINI VALVES (DN 8)

KOD CODE	EBAT / SIZE d ₁ x d	AMBALAJ ADEDİ PACKING QUANTITY	KOLİ ADEDİ BOX QUANTITY	ÇUVAL ADEDİ SACK QUANTITY
11422	16 x 16	50	450	500
11424	16 x 20	50	450	400
11442	20 x 16	50	450	500
11444	20 x 20	50	400	500
11452	25 x 16	50	400	450
11454	25 x 20	50	400	400

KOD CODE	EBAT / SIZE d x G	AMBALAJ ADEDİ PACKING QUANTITY	KOLİ ADEDİ BOX QUANTITY	ÇUVAL ADEDİ SACK QUANTITY
11521	16 x 1/2"	50	700	750
11522	16 x 3/4"	50	700	700
11541	20 x 1/2"	50	700	700
11542	20 x 3/4"	50	650	650
11551	25 x 1/2"	50	600	650
11552	25 x 3/4"	50	600	650

KOD CODE	EBAT / SIZE d x d	AMBALAJ ADEDİ PACKING QUANTITY	KOLİ ADEDİ BOX QUANTITY	ÇUVAL ADEDİ SACK QUANTITY
11622	16 x 16	50	700	700
11624	16 x 20	50	600	700
11625	16 x 25	50	600	600
11644	20 x 20	50	600	650
11645	20 x 25	50	550	600
11655	25 x 25	50	500	600

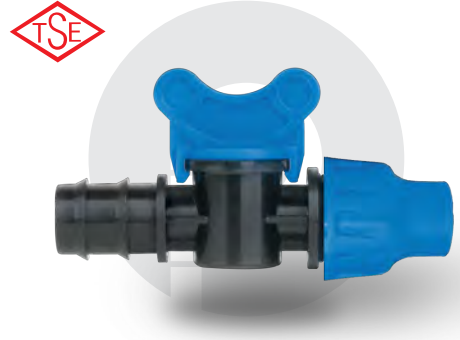

MİNİ VANA KURTAĞZI - KİLİTLİ BAĞLANTI

MINI VALVE BARBED - LOCK TYPE

МИНИ-КРАН РЕБРИСТЫЙ - С ЗАМКОМ

قفل صغير شائكة - نوعية اقفال

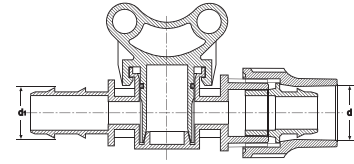

MİNİ VANA KURTAĞZI - ERKEK

MINI VALVE BARBED - MALE

МИНИ-КРАН РЕБРИСТЫЙ - «ШТУЦЕР»

قفل صغير شائكة - سن خارج

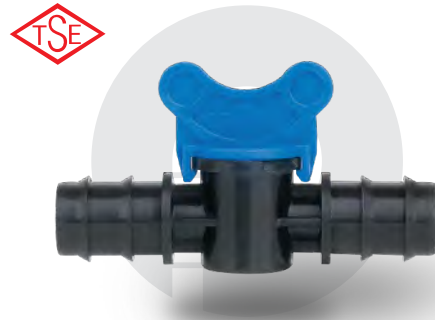
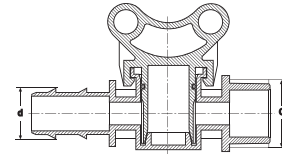

MİNİ VANA KURTAĞZI

MINI VALVE BARBED

МИНИ-КРАН РЕБРИСТЫЙ

قفل صغير شائكة

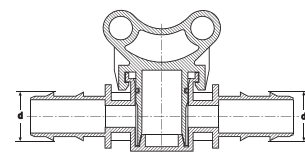

صمام صغير لخط التنقيط / МИНИ-КРАНЫ ДЛЯ КАПЕЛЬНОГО ОРОШЕНИЯ

DAMLA SULAMA MİNİ VANALAR (DN 8) / DRIPLINE MINI VALVES (DN 8)

صمام صغير لخط التنقيط / МИНИ-КРАНЫ ДЛЯ КАПЕЛЬНОГО ОРОШЕНИЯ

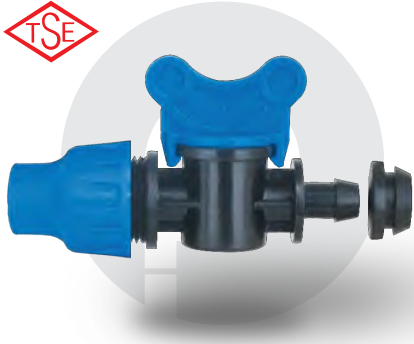

MİNİ VANA KİLİTLİ BAĞLANTI - GROMMET

MINI VALVE LOCK TYPE - GROMMET

МИНИ-КРАН С ЗАМКОМ - УПЛОТНИТЕЛЬНОЕ КОЛЬЦО

اقفال الصغيرة نوعية اقفال-مع حلقة تثبيت

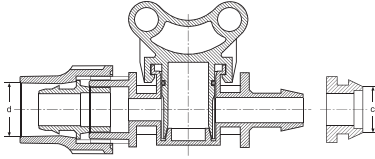

KOD CODE	EBAT / SIZE d x c	AMBALAJ ADEDİ PACKING QUANTITY	KOLİ ADEDİ BOX QUANTITY	ÇUVAL ADEDİ SACK QUANTITY
118122	16 x 16	50	450	550
118124	16 x 20	50	450	450
118142	20 x 16	50	400	500
118144	20 x 20	50	400	450



MİNİ VANA KİLİTLİ BAĞLANTI - CONTASIZ ÇIKIŞ

MINI VALVE LOCK TYPE - OFFTAKE WITHOUT GASKET

МИНИ-КРАН С ЗАМКОМ - ПОДЖИМ

اقفال الصغيرة نوعية اقفال-بدون حلقة تثبيت

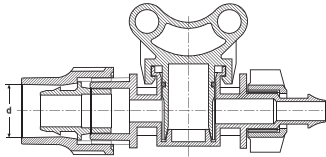

KOD CODE	EBAT / SIZE d	AMBALAJ ADEDİ PACKING QUANTITY	KOLİ ADEDİ BOX QUANTITY	ÇUVAL ADEDİ SACK QUANTITY
118162	16	50	400	500
118182	20	50	400	450



MİNİ VANA ERKEK - GROMMET

MINI VALVE MALE - GROMMET

МИНИ-КРАН «ШТУЦЕР» - УПЛОТНИТЕЛЬНОЕ КОЛЬЦО

اقفال الصغيرة -مع حلقة تثبيت

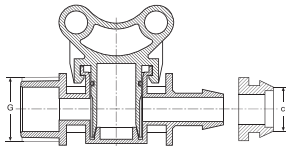

KOD CODE	EBAT / SIZE G x c	AMBALAJ ADEDİ PACKING QUANTITY	KOLİ ADEDİ BOX QUANTITY	ÇUVAL ADEDİ SACK QUANTITY
118212	1/2" x 16	50	700	750
118214	1/2" x 20	50	600	700
118222	3/4" x 16	50	650	700
118224	3/4" x 20	50	600	650

DAMLA SULAMA MİNİ VANALAR (DN 8) / DRIPLINE MINI VALVES (DN 8)

KOD CODE	EBAT / SIZE G	AMBALAJ ADEDİ PACKING QUANTITY	KOLİ ADEDİ BOX QUANTITY	ÇUVAL ADEDİ SACK QUANTITY
118272	1/2"	50	600	650
118282	3/4"	50	550	600

KOD CODE	EBAT / SIZE d x c	AMBALAJ ADEDİ PACKING QUANTITY	KOLİ ADEDİ BOX QUANTITY	ÇUVAL ADEDİ SACK QUANTITY
118322	16 x 16	50	700	750
118324	16 x 20	50	600	600
118342	20 x 16	50	600	700
118344	20 x 20	50	600	600
118352	25 x 16	50	550	600
118354	25 x 20	50	500	600

KOD CODE	EBAT / SIZE d	AMBALAJ ADEDİ PACKING QUANTITY	KOLİ ADEDİ BOX QUANTITY	ÇUVAL ADEDİ SACK QUANTITY
118362	16	50	600	650
118382	20	50	550	600
118392	25	50	550	600



MİNİ VANA ERKEK - CONTASIZ ÇIKIŞ

MINI VALVE MALE - OFFTAKE WITHOUT GASKET

МИНИ-КРАН «ШТУЦЕР» – ПОДЖИМ

اقفال الصغيرة - بدون حلقة تثبيت

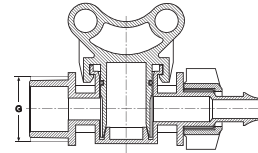

MİNİ VANA KURTAĞZI - GROMMET

MINI VALVE BARBED - GROMMET

МИНИ-КРАН РЕБРИСТЫЙ - УПЛОТНИТЕЛЬНОЕ КОЛЬЦО

قفل صغير شائكة-مع حلقة تثبيت

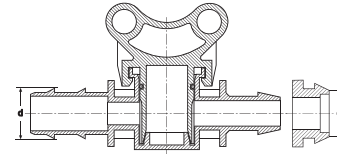

MİNİ VANA KURTAĞZI - CONTASIZ ÇIKIŞ

MINI VALVE BARBED - OFFTAKE WITHOUT GASKET

МИНИ-КРАН РЕБРИСТЫЙ – ПОДЖИМ

قفل صغير شائكة-بدون حلقة تثبيت

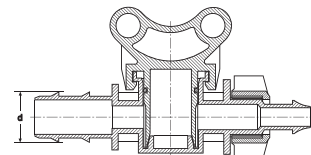

صمام صغير لخط التنقيط / МИНИ-КРАНЫ ДЛЯ КАПЕЛЬНОГО ОРОШЕНИЯ

DAMLA SULAMA MİNİ VANALAR (DN 8) / DRIPLINE MINI VALVES (DN 8)

صمام صغير لخط التقيط / МИНИ-КРАНЫ ДЛЯ КАПЕЛЬНОГО ОРОШЕНИЯ



MİNİ VANA DAMLAMA - GROMMET

MINI VALVE DRIPLINE - GROMMET
МИНИ-КРАН ДЛЯ ТРУБЫ КАПЕЛЬНОГО ПОЛИВА -
УПЛОТНИТЕЛЬНОЕ КОЛЬЦО

قفل صغير تقطير - مع حلقة تثبيت

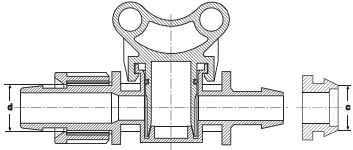

KOD CODE	EBAT / SIZE d x c	AMBALAJ ADEDİ PACKING QUANTITY	KOLİ ADEDİ BOX QUANTITY	ÇUVAL ADEDİ SACK QUANTITY
118422	16 x 16	50	600	650
118442	20 x 16	50	550	600
118444	20 x 20	50	500	600



MİNİ VANA DAMLAMA - CONTASIZ ÇIKIŞ

MINI VALVE DRIPLINE - OFFTAKE WITHOUT GASKET
МИНИ-КРАН ДЛЯ ТРУБЫ КАПЕЛЬНОГО ПОЛИВА - ПОДЖИМ

قفل صغير تقطير - بدون حلقة تثبيت

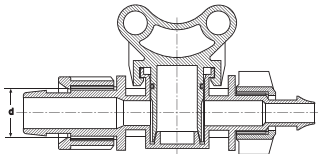

KOD CODE	EBAT / SIZE d	AMBALAJ ADEDİ PACKING QUANTITY	KOLİ ADEDİ BOX QUANTITY	ÇUVAL ADEDİ SACK QUANTITY
118462	16	50	550	600
118482	20	50	500	550



MİNİ VANA CONTASIZ ÇIKIŞ

MINI VALVE OFFTAKE WITHOUT GASKET
МИНИ-КРАН С ПОДЖИМОМ

قفل صغير بدون حلقة تثبيت

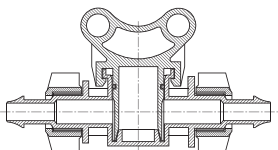

KOD CODE	EBAT SIZE-mm	AMBALAJ ADEDİ PACKING QUANTITY	KOLİ ADEDİ BOX QUANTITY	ÇUVAL ADEDİ SACK QUANTITY
118499	12	50	550	600

KOD CODE	EBAT / SIZE d x d ₁	AMBALAJ ADEDİ PACKING QUANTITY	KOLİ ADEDİ BOX QUANTITY	ÇUVAL ADEDİ SACK QUANTITY
118622	16 x 16	50	450	450
118642	20 x 16	50	400	400
118644	20 x 20	50	400	400

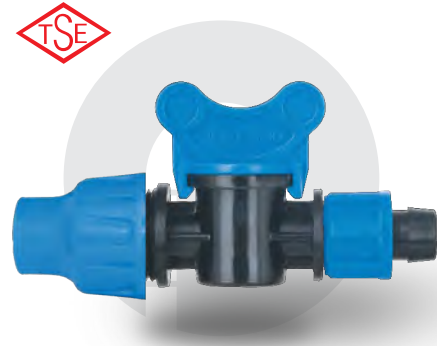

MİNİ VANA KİLİTLİ BAĞLANTI - DAMLAMA

MINI VALVE LOCK TYPE - DRIPLINE
 МИНИ-КРАН С ЗАМКОМ – ТРУБА ДЛЯ КАПЕЛЬНОГО ПОЛИВА
 قفل صغير نوعية اففال - تقطير

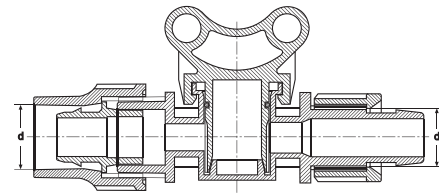

KOD CODE	EBAT / SIZE G x d	AMBALAJ ADEDİ PACKING QUANTITY	KOLİ ADEDİ BOX QUANTITY	ÇUVAL ADEDİ SACK QUANTITY
118712	½" x 16	50	650	650
118714	½" x 20	50	600	600
118722	¾" x 16	50	600	600
118724	¾" x 20	50	550	600

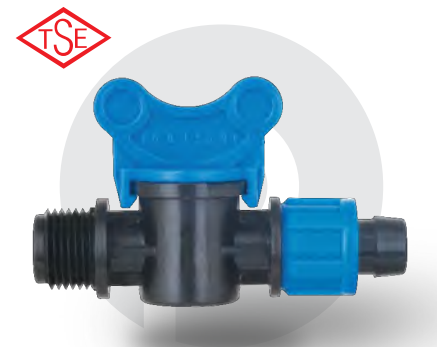

MİNİ VANA ERKEK - DAMLAMA

MINI VALVE MALE - DRIPLINE
 МИНИ-КРАН «ШТУЦЕР» – ДЛЯ ТРУБЫ КАПЕЛЬНОГО ПОЛИВА
 قفل صغير سن خارج - تقطير

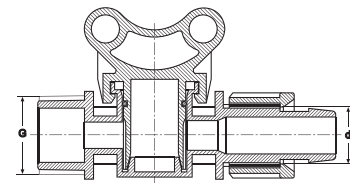

YASSI DAMLA SULAMA MİNİ VANALAR (DN 8) / TAPE MINI VALVES (DN 8)

صمام صغير أفقي ذات وصلة تنقيط مسطحة / МИНИ-КРАНЫ ДЛЯ КАПЕЛЬНОЙ ЛЕНТЫ



MİNİ VANA KURTAĞZI - DAMLAMA

MINI VALVE BARBED - DRIPLINE

МИНИ-КРАН РЕБРИСТЫЙ - ДЛЯ ТРУБЫ КАПЕЛЬНОГО ПОЛИВА

قفل صغير شائكة - تقطير

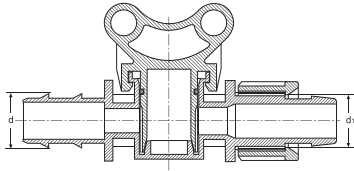

KOD CODE	EBAT / SIZE d x d ₁	AMBALAJ ADEDİ PACKING QUANTITY	KOLİ ADEDİ BOX QUANTITY	ÇUVAL ADEDİ SACK QUANTITY
118822	16 x 16	50	600	650
118824	16 x 20	50	550	600
118842	20 x 16	50	550	600
118844	20 x 20	50	500	600



MİNİ VANA DAMLAMA

MINI VALVE DRIPLINE

МИНИ-КРАН ДЛЯ ТРУБЫ КАПЕЛЬНОГО ПОЛИВА

قفل صغير تقطير

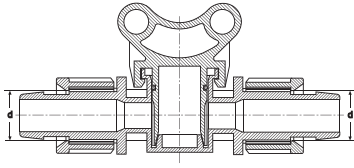

KOD CODE	EBAT / SIZE d x d	AMBALAJ ADEDİ PACKING QUANTITY	KOLİ ADEDİ BOX QUANTITY	ÇUVAL ADEDİ SACK QUANTITY
118922	16 x 16	50	550	600
118924	16 x 20	50	500	550
118944	20 x 20	50	450	500



MİNİ VANA YASSI DAMLAMA - GROMMET

MINI VALVE TAPE - GROMMET

МИНИ-КРАН КАПЕЛЬНАЯ ЛЕНТА - УПЛОТНИТЕЛЬНОЕ КОЛЬЦО

قفل صغير شريطية - مع حلقة تثبيت

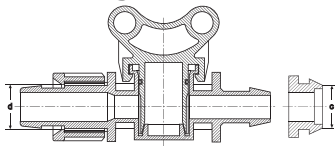

KOD CODE	EBAT / SIZE d x c	AMBALAJ ADEDİ PACKING QUANTITY	KOLİ ADEDİ BOX QUANTITY	ÇUVAL ADEDİ SACK QUANTITY
118522	17 x 16	50	650	650
118524	17 x 20	50	600	600
118542	22 x 16	50	500	550
118544	22 x 20	50	450	550

YASSI DAMLA SULAMA MİNİ VANALAR (DN 8) / TAPE MINI VALVES (DN 8)

KOD CODE	EBAT / SIZE d	AMBALAJ ADEDİ PACKING QUANTITY	KOLİ ADEDİ BOX QUANTITY	ÇUVAL ADEDİ SACK QUANTITY
118562	17	50	550	600
118582	22	50	400	500



MİNİ VANA YASSI DAMLAMA - CONTASIZ ÇIKIŞ

MINI VALVE TAPE - OFFTAKE WITHOUT GASKET

МИНИ-КРАН КАПЕЛЬНАЯ ЛЕНТА - ПОДЖИМ

قفل صغير شريطية - بدون حلقة تثبيت

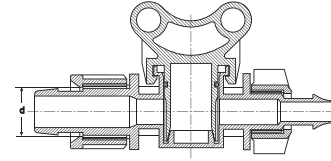

KOD CODE	EBAT / SIZE d x d ₁	AMBALAJ ADEDİ PACKING QUANTITY	KOLİ ADEDİ BOX QUANTITY	ÇUVAL ADEDİ SACK QUANTITY
119022	16 x 17	50	450	450
119024	16 x 22	50	350	400
119042	20 x 17	50	400	450
119044	20 x 22	50	350	400

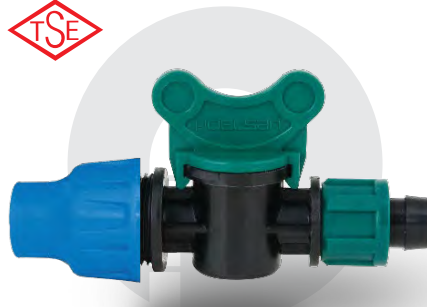

MİNİ VANA KİLİTLİ BAĞLANTI - YASSI DAMLAMA

MINI VALVE LOCK TYPE - TAPE

МИНИ-КРАН ЗАМОК - КАПЕЛЬНАЯ ЛЕНТА

قفل صغير نوعية اقفال- شريطية

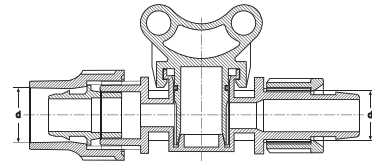

KOD CODE	EBAT / SIZE G x d	AMBALAJ ADEDİ PACKING QUANTITY	KOLİ ADEDİ BOX QUANTITY	ÇUVAL ADEDİ SACK QUANTITY
119112	1/2" x 17	50	600	600
119114	1/2" x 22	50	500	500
119122	3/4" x 17	50	550	600
119124	3/4" x 22	50	450	500



MİNİ VANA ERKEK - YASSI DAMLAMA

MINI VALVE MALE - TAPE

МИНИ-КРАН «ШТУЦЕР» - КАПЕЛЬНАЯ ЛЕНТА

قفل صغير شريطية - سن خارج

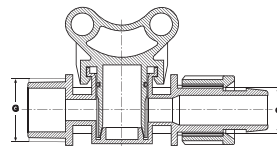

صمام صغير أفقي ذات وصلة تنقيط مسطحة / МИНИ-КРАНЫ ДЛЯ КАПЕЛЬНОЙ ЛЕНТЫ

YASSI DAMLA SULAMA MİNİ VANALAR (DN 8) / TAPE MINI VALVES (DN 8)

صمام صغير أفقي ذات وصلة تنقيط مسطحة / МИНИ-КРАНЫ ДЛЯ КАПЕЛЬНОЙ ЛЕНТЫ



MİNİ VANA KURTAĞZI - YASSI DAMLAMA

MINI VALVE BARBED - TAPE
МИНИ-КРАН РЕБРИСТЫЙ - КАПЕЛЬНАЯ ЛЕНТА
قفل صغير شائكة - سن خارج

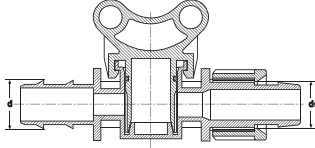

KOD CODE	EBAT / SIZE d x d ₁	AMBALAJ ADEDİ PACKING QUANTITY	KOLİ ADEDİ BOX QUANTITY	ÇUVAL ADEDİ SACK QUANTITY
119222	16 x 17	50	600	700
119224	16 x 22	50	500	600
119242	20 x 17	50	600	650
119244	20 x 22	50	450	500
119254	25 x 22	50	450	500



MİNİ VANA DAMLAMA - YASSI DAMLAMA

MINI VALVE DRIPLINE - TAPE
МИНИ-КРАН ДЛЯ ТРУБЫ КАПЕЛЬНОГО ПОЛИВА - КАПЕЛЬНАЯ ЛЕНТА
قفل صغير شائكة - شريطية

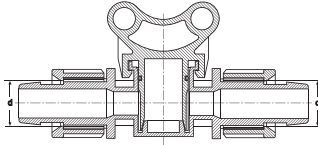

KOD CODE	EBAT / SIZE d x d ₁	AMBALAJ ADEDİ PACKING QUANTITY	KOLİ ADEDİ BOX QUANTITY	ÇUVAL ADEDİ SACK QUANTITY
119322	16 x 17	50	550	600
119324	16 x 22	50	450	500
119342	20 x 17	50	500	550
119344	20 x 22	50	400	450



MİNİ VANA YASSI DAMLAMA

MINI VALVE TAPE
МИНИ-КРАН ДЛЯ КАПЕЛЬНОЙ ЛЕНТЫ
قفل صغير شريطية

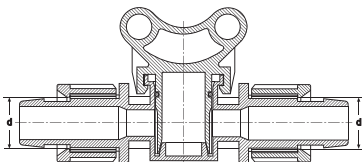

KOD CODE	EBAT / SIZE d x d	AMBALAJ ADEDİ PACKING QUANTITY	KOLİ ADEDİ BOX QUANTITY	ÇUVAL ADEDİ SACK QUANTITY
119422	17 x 17	50	600	600
119444	22 x 22	50	400	450

KOD CODE	EBAT / SIZE d x c	AMBALAJ ADEDİ PACKING QUANTITY	KOLİ ADEDİ BOX QUANTITY	ÇUVAL ADEDİ SACK QUANTITY
119522	17 x 16	50	650	700



MİNİ VANA YÜZÜKLÜ YASSI - GROMMET

MINI VALVE TAPE (WITH RING) - GROMMET
MİNİ-KRAN KAPELYNOY LENTA (S KOLYCOM) - UPLOTNITEL'NOYE KOLYCO
قفص صغير شريطية (مع حلقة) تثبيت

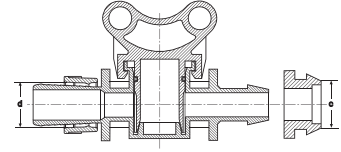

KOD CODE	EBAT / SIZE d	AMBALAJ ADEDİ PACKING QUANTITY	KOLİ ADEDİ BOX QUANTITY	ÇUVAL ADEDİ SACK QUANTITY
119622	17	50	600	650



MİNİ VANA YÜZÜKLÜ YASSI - CONTASIZ ÇIKIŞ
MINI VALVE TAPE (WITH RING) - OFFTAKE WITHOUT GASKET
MİNİ-KRAN KAPELYNOY LENTA (S KOLYCOM) - PODJIM
قفص صغير شريطية (مع حلقة) قابلة للانفصال بدون حلقة تثبيت

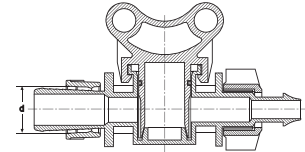

KOD CODE	EBAT / SIZE d x G	AMBALAJ ADEDİ PACKING QUANTITY	KOLİ ADEDİ BOX QUANTITY	ÇUVAL ADEDİ SACK QUANTITY
119722	17 x 1/2"	50	650	750

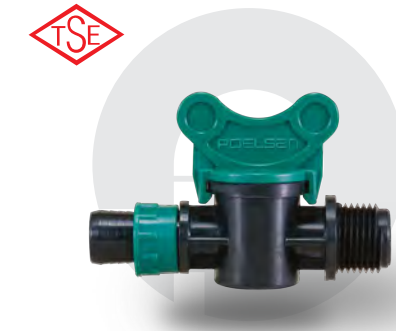

MİNİ VANA YÜZÜKLÜ YASSI - ERKEK
MINI VALVE TAPE (WITH RING) - MALE
MİNİ-KRAN KAPELYNOY LENTA (S KOLYCOM) - «ŞTUZER»
قفص صغير شريطية (مع حلقة) سن خارج

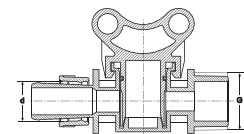



KOD CODE	EBAT / SIZE d x d ₁	AMBALAJ ADEDİ PACKING QUANTITY	KOLİ ADEDİ BOX QUANTITY	ÇUVAL ADEDİ SACK QUANTITY
119822	17 x 16	50	650	750

MİNİ VANA YÜZÜKLÜ YASSI - KURTAĞZI

MINI VALVE TAPE (WITH RING) - BARBED
МИНИ-КРАН КАПЕЛЬНАЯ ЛЕНТА (С КОЛЬЦОМ) – РЕБРИСТЫЙ
قفل صغير شريطية (مع حلقة) شائكة

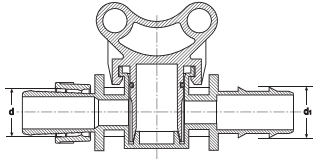

KOD CODE	EBAT / SIZE d x d	AMBALAJ ADEDİ PACKING QUANTITY	KOLİ ADEDİ BOX QUANTITY	ÇUVAL ADEDİ SACK QUANTITY
119922	17 x 17	50	650	700

MİNİ VANA YÜZÜKLÜ YASSI

MINI VALVE TAPE (WITH RING)
МИНИ-КРАН ДЛЯ КАПЕЛЬНОЙ ЛЕНТЫ (С КОЛЬЦОМ)
قفل صغير شريطية (مع حلقة)

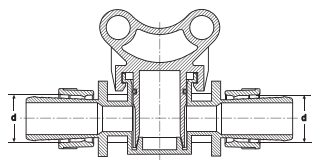

MINİ VANALAR (DN 15)

MINI VALVES (DN 15)

МИНИ КРАНЫ

اقفال الصغيرة (DN15)

Özellikler

- + Su geçiş çapı 15 mm.
- + Darbelere karşı dayanıklı, yüksek kaliteli polipropilen hammaddeden üretilmiştir.
- + Uzun mesafe damlama ve yassı borular için geniş su geçişi sağlar.
- + Sulama sisteminizi kolayca açıp kapayarak kontrol etmenizi sağlar.
- + UV ışınlarını geçirmediği için yosunlanmaya ve bakteri üremesine izin vermez.
- + İç yüzeyleri homojen ve gözeneksizdir.
- + Suyun kokusunu ve tadını değiştirebilecek zararlı bileşikler içermez.

Specifications

- + Water pass diameter 15 mm.
- + It has been produced from high quality polipropilen raw material and it has resistance to impact.
- + It allows a wide water pass for long distance dripline, and tape pipes.
- + It supplies an easy on-off control on the irrigation system.
- + They prevent alga and bacteria forming due to UV proof (ultraviolet beam) structure.
- + It has a homogeneous and non-porous inner surface.
- + It does not contain any harmful compounds which can change the taste or the smell of the water.

GARANTİ VERİLEN BASINÇ DEĞERİ : PN 2
GUARANTEED PRESSURE VALUE : PN 2

TS EN ISO 9261

KULLANIM ALANLARI

- + Tarımsal Sulama
- + Peyzaj Sektörü
- + Seralar

INSTALLATION AREAS

- + Agricultural Irrigation
- + Landscaping Systems
- + Greenhouses



DAMLA SULAMA MİNİ VANALAR (DN 15) / DRIPLINE MINI VALVES (DN 15)

صمام صغير لخط التثقيط / МИНИ-КРАНЫ ДЛЯ КАПЕЛЬНОГО ОРОШЕНИЯ



MİNİ VANA ERKEK

MINI VALVE MALE
МИНИ-КРАН «ШТУЦЕР»
قفل صغير - سن خارج

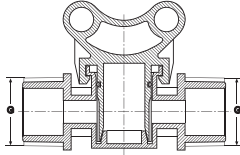

KOD CODE	EBAT / SIZE G x G	AMBALAJ ADEDİ PACKING QUANTITY	KOLİ ADEDİ BOX QUANTITY	ÇUVAL ADEDİ SACK QUANTITY
120011	1/2" x 1/2"	25	300	300
120021	3/4" x 1/2"	25	300	300
120022	3/4" x 3/4"	25	300	325
120031	1" x 1/2"	25	300	300
120032	1" x 3/4"	25	275	300
120033	1" x 1"	25	250	275
120034	1 1/4" x 1 1/4"	25	175	200



MİNİ VANA KİLİTLİ BAĞLANTI

MINI VALVE LOCK TYPE
МИНИ-КРАН С ЗАМКОМ
اقفال الصغيرة نوعية اقفال

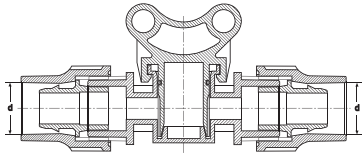

KOD CODE	EBAT / SIZE d x d	AMBALAJ ADEDİ PACKING QUANTITY	KOLİ ADEDİ BOX QUANTITY	ÇUVAL ADEDİ SACK QUANTITY
120044	20 x 20	25	200	225
120054	25 x 20	25	175	175
120055	25 x 25	25	150	175
120066	32 x 32	10	100	110



MİNİ VANA KİLİTLİ BAĞLANTI - ERKEK

MINI VALVE LOCK TYPE - MALE
МИНИ-КРАН С ЗАМКОМ «ШТУЦЕР»
اقفال الصغيرة نوعية اقفال- سن خارج

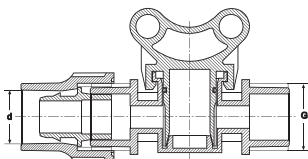

KOD CODE	EBAT / SIZE d x G	AMBALAJ ADEDİ PACKING QUANTITY	KOLİ ADEDİ BOX QUANTITY	ÇUVAL ADEDİ SACK QUANTITY
120121	20 x 1/2"	25	250	275
120122	20 x 3/4"	25	250	275
120131	25 x 1/2"	25	200	225
120132	25 x 3/4"	25	200	225
120133	25 x 1"	25	200	225

DAMLA SULAMA MİNİ VANALAR (DN 15) / DRIPLINE MINI VALVES (DN 15)

KOD CODE	EBAT / SIZE d x d ₁	AMBALAJ ADEDİ PACKING QUANTITY	KOLİ ADEDİ BOX QUANTITY	ÇUVAL ADEDİ SACK QUANTITY
120142	20 x 20	25	250	250
120143	20 x 25	25	225	250
120152	25 x 20	25	175	200
120153	25 x 25	25	175	200



MİNİ VANA KİLİTLİ BAĞLANTI - KURTAĞZI

MINI VALVE LOCK TYPE - BARBED

МИНИ КРАН (СИНИЙ) - ШТУЦЕР

قفل صغير شائكة - نوعية اقفال

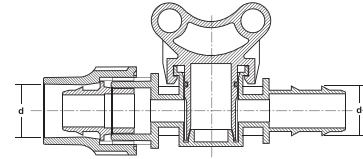

KOD CODE	EBAT / SIZE d x c	AMBALAJ ADEDİ PACKING QUANTITY	KOLİ ADEDİ BOX QUANTITY	ÇUVAL ADEDİ SACK QUANTITY
120172	20 x 20	25	200	250
120182	25 x 20	25	200	225



MİNİ VANA KİLİTLİ BAĞLANTI - GROMMET

MINI VALVE LOCK TYPE - GROMMET

МИНИ-КРАН С ЗАМКМ - УПЛОТНИТЕЛЬНОЕ КОЛЬЦО

اقفال الصغيرة نوعية اقفال-مع حلقة تثبيت

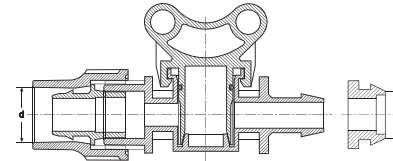

KOD CODE	EBAT / SIZE d x d	AMBALAJ ADEDİ PACKING QUANTITY	KOLİ ADEDİ BOX QUANTITY	ÇUVAL ADEDİ SACK QUANTITY
120222	20 x 20	25	300	325
120232	25 x 20	25	275	325
120233	25 x 25	25	250	300



MİNİ VANA KURTAĞZI

MINI VALVE BARBED

МИНИ-КРАН РЕБРИСТЫЙ

قفل صغير شائكة

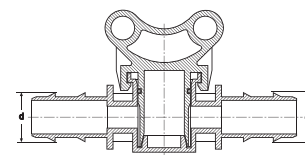

صمام صغير لخط التنقيط / ميني-كران للخط التنقيط / ميني-كران للخط التنقيط / ميني-كران للخط التنقيط

DAMLA SULAMA MİNİ VANALAR (DN 15) / DRIPLINE MINI VALVES (DN 15)

صمام صغير لخط التنقيط / МИНИ-КРАНЫ ДЛЯ КАПЕЛЬНОГО ОРОШЕНИЯ



MİNİ VANA KURTAĞZI - ERKEK

MINI VALVE BARBED - MALE
МИНИ-КРАН РЕБРИСТЫЙ - «ШТУЦЕР»
قفل صغير شائكة - سن خارج

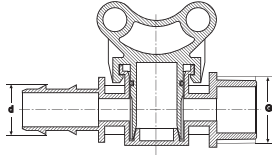

KOD CODE	EBAT / SIZE d x G	AMBALAJ ADEDİ PACKING QUANTITY	KOLİ ADEDİ BOX QUANTITY	ÇUVAL ADEDİ SACK QUANTITY
120321	20 x 1/2"	25	300	350
120322	20 x 3/4"	25	300	350
120323	20 x 1"	25	250	300
120331	25 x 1/2"	25	275	325
120332	25 x 3/4"	25	275	325
120333	25 x 1"	25	250	300



MİNİ VANA KURTAĞZI - GROMMET

MINI VALVE BARBED - GROMMET
МИНИ-КРАН РЕБРИСТЫЙ - УПЛОТНИТЕЛЬНОЕ КОЛЬЦО
قفل صغير شائكة-مع حلقة تثبيت

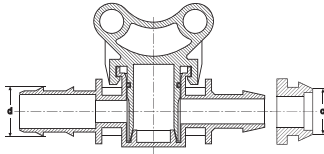

KOD CODE	EBAT / SIZE d x c	AMBALAJ ADEDİ PACKING QUANTITY	KOLİ ADEDİ BOX QUANTITY	ÇUVAL ADEDİ SACK QUANTITY
120382	25 x 20	25	275	325



MİNİ VANA DAMLAMA

MINI VALVE DRIPLINE
МИНИ-КРАН ДЛЯ ТРУБЫ КАПЕЛЬНОГО ПОЛИВА
قفل صغير تنقيط

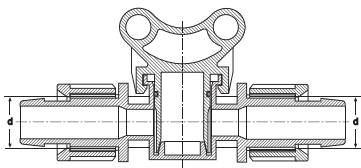

KOD CODE	EBAT / SIZE d x d	AMBALAJ ADEDİ PACKING QUANTITY	KOLİ ADEDİ BOX QUANTITY	ÇUVAL ADEDİ SACK QUANTITY
120422	20 x 20	25	250	300

DAMLA SULAMA MİNİ VANALAR (DN 15) / DRIPLINE MINI VALVES (DN 15)

صمام صغير لخط التنقيط / ميني-كرانين للخط التنقيط / ميني-كرانين للخط التنقيط / ميني-كرانين للخط التنقيط

KOD CODE	EBAT / SIZE d x G	AMBALAJ ADEDİ PACKING QUANTITY	KOLİ ADEDİ BOX QUANTITY	ÇUVAL ADEDİ SACK QUANTITY
120521	20 x 1/2"	25	250	300
120522	20 x 3/4"	25	250	300



MİNİ VANA DAMLAMA - ERKEK

MINI VALVE DRIPLINE - MALE
 МИНИ КРАН (СИНИЙ) ДЛЯ КАПЕЛЬНЫХ ТРУБОК - РЕЗЬБА
 قفل صغير سن خارج - تقطير

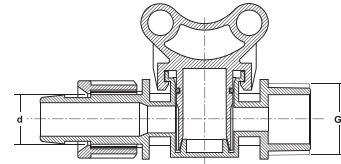

MİNİ VANA DAMLAMA - KURTAĞZI

MINI VALVE DRIPLINE - BARBED
 МИНИ КРАН (СИНИЙ) ДЛЯ КАПЕЛЬНЫХ ТРУБОК - ШТУЦЕР
 قفل صغير تقطير - شائكة

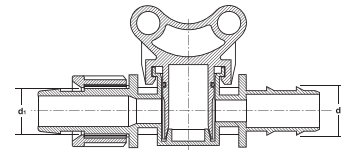

KOD CODE	EBAT / SIZE d, x d	AMBALAJ ADEDİ PACKING QUANTITY	KOLİ ADEDİ BOX QUANTITY	ÇUVAL ADEDİ SACK QUANTITY
120622	20 x 20	25	250	300



MİNİ VANA DAMLAMA - GROMMET

MINI VALVE DRIPLINE - GROMMET
 МИНИ-КРАН ДЛЯ ТРУБЫ КАПЕЛЬНОГО ПОЛИВА - УПЛОТНИТЕЛЬНОЕ КОЛЬЦО
 قفل صغير تقطير-مع حلقة تثبيت

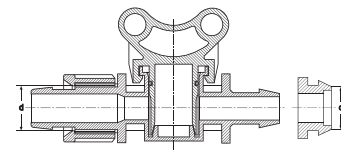

KOD CODE	EBAT / SIZE d x c	AMBALAJ ADEDİ PACKING QUANTITY	KOLİ ADEDİ BOX QUANTITY	ÇUVAL ADEDİ SACK QUANTITY
120672	20 x 20	25	250	300

YASSI DAMLA SULAMA MİNİ VANALAR (DN 15) / TAPE MINI VALVES (DN 15)

صمام صغير أفقي ذات وصلة تنقيط مسطحة / МИНИ-КРАНЫ ДЛЯ КАПЕЛЬНОЙ ЛЕНТЫ



MİNİ VANA YASSI DAMLAMA

MINI VALVE TAPE

МИНИ-КРАН ДЛЯ КАПЕЛЬНОЙ ЛЕНТЫ

قفل صغير شريطية

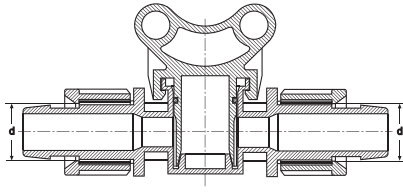

KOD CODE	EBAT / SIZE d x d	AMBALAJ ADEDİ PACKING QUANTITY	KOLİ ADEDİ BOX QUANTITY	ÇUVAL ADEDİ SACK QUANTITY
120722	22 x 22	25	200	250
120733	25 x 25	25	200	200



MİNİ VANA YASSI DAMLAMA - ERKEK

MINI VALVE TAPE - MALE

МИНИ КРАН (ЗЕЛЁНЫЙ) ЛЕНТА - РЕЗЬБА

قفل صغير شريطية سن خارج

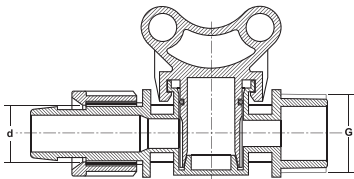

KOD CODE	EBAT / SIZE d x G	AMBALAJ ADEDİ PACKING QUANTITY	KOLİ ADEDİ BOX QUANTITY	ÇUVAL ADEDİ SACK QUANTITY
120821	22 x 1/2"	25	250	300
120822	22 x 3/4"	25	250	275
120831	25 x 1/2"	25	225	300
120832	25 x 3/4"	25	225	275
120833	25 x 1"	25	200	250

YASSI DAMLA SULAMA MİNİ VANALAR (DN 15) / TAPE MINI VALVES (DN 15)

KOD CODE	EBAT / SIZE d, x d	AMBALAJ ADEDİ PACKING QUANTITY	KOLİ ADEDİ BOX QUANTITY	ÇUVAL ADEDİ SACK QUANTITY
120922	22 x 20	25	250	300
120923	22 x 25	25	225	275
120932	25 x 20	25	225	275
120933	25 x 25	25	225	250



MİNİ VANA YASSI DAMLAMA - KURTAĞZI

MINI VALVE TAPE - BARBED
 МИНИ КРАН (ЗЕЛЁНЫЙ) ЛЕНТА - ШТУЦЕР
 قفل صغير شريطية شائكة

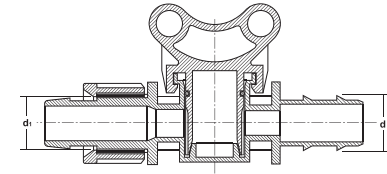

KOD CODE	EBAT / SIZE d x c	AMBALAJ ADEDİ PACKING QUANTITY	KOLİ ADEDİ BOX QUANTITY	ÇUVAL ADEDİ SACK QUANTITY
120972	22 x 20	25	225	250
120982	25 x 20	25	225	250



MİNİ VANA YASSI DAMLAMA - GROMMET

MINI VALVE TAPE - GROMMET
 МИНИ-КРАН КАПЕЛЬНАЯ ЛЕНТА - УПЛОТНИТЕЛЬНОЕ КОЛЬЦО
 قفل صغير شريطية - مع حلقة تثبيت

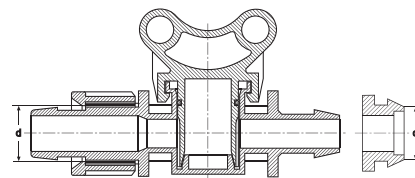

صمام صغير أفقي ذات وصلة تنقيط مسطحة / МИНИ-КРАНЫ ДЛЯ КАПЕЛЬНОЙ ЛЕНТЫ

MINİ VANALAR (DN 8)

MINI VALVES (DN 8)

МИНИ КРАНЫ

اقفال الصغيرة (DN 8)

DİKKAT EDİLMESİ GEREKEN HUSUSLAR

- + Grommet Conta ile çıkış almak için kullanılacak Grommet Contalı Mini Vana çeşidine göre delik çapı 16 mm veya 20 mm olacak şekilde boru delinmelidir.
- + Contasız Çıkış, Layflat ve Alçak Yoğunluklu Polietilen (AYPE) Borulardan (Düz Damla Sulama Borusu) Ø16 mm ve Ø20 mm Yuvarlak Damla Sulama Borularına çıkış almak için kullanılır. Contasız Çıkış Ucu ile çıkış almak için boru, delik çapı 8 mm olacak şekilde delinmelidir.
- + Mini Vana Contasız Çıkış ürünü, Layflat borulardan, Ø12 mm Spagetti Borulara çıkış almak için kullanılır. Contasız Çıkış Ucu ile çıkış almak için boru, delik çapı 8 mm olacak şekilde delinmelidir.

POINTS TO TAKE INTO CONSIDERATION

- + For a proper offtake with the Grommet Gasket, the pipe should be punched 16 mm or 20 mm according to the Mini Valve with Grommet Gasket to be used.
- + The items with offtake end without gasket are used for joining the Layflat and Low Density Polyethylene (LDPE) Pipes (Flat Drip Irrigation Pipe) with Round Drip Irrigation Pipes (Ø16 mm & Ø20 mm). For a proper offtake, the pipe should be punched 8 mm.
- + The Mini Valve Offtake without gasket item is used for the connection offtake from Layflat pipes to 12 mm Microtube Pipes with Ø12 mm Microtube Pipes. For a proper offtake, the pipe should be punched 8 mm.

MINİ VANALAR (DN 15)

MINI VALVES (DN 15)

МИНИ КРАНЫ

اقفال الصغيرة (DN 15)

DİKKAT EDİLMESİ GEREKEN HUSUSLAR

- + Grommet Conta ile çıkış almak için kullanılacak Grommet Contalı Mini Vana çeşidine göre delik çapı 20 mm olacak şekilde boru delinmelidir.

POINTS TO TAKE INTO CONSIDERATION

- + For a proper offtake with the Grommet Gasket, the pipe should be punched 20 mm according to the Mini Valve with Grommet Gasket to be used.

DAMLA SULAMA KURTAĞZI EK PARÇALARI

DRIPLINE BARBED FITTINGS

ФИТИНГИ РЕБРИСТЫЕ ДЛЯ КАПЕЛЬНОГО ОРОШЕНИЯ

مواد التقطير شائكة

Özellikler

- + Darbelere karşı dayanıklı, yüksek kaliteli polipropilen hammaddeden üretilmiştir.
- + Ø16 mm ve Ø20 mm Alçak Yoğunluklu Polietilen (AYPE) Borularda (Düz Damla Sulama Borusu) kullanılır.
- + Ø16 mm ve Ø20 mm Yuvarlak Damla Sulama Borularında kullanılır.
- + UV ışınlarını geçirmediği için yosunlanmaya ve bakteri üremesine izin vermez.
- + İç yüzeyleri homojen ve gözeneksizdir.
- + Suyun kokusunu ve tadını değiştirebilecek zararlı bileşikler içermez.

Specifications

- + It has been produced from high quality polypropylene raw material and it has resistance to impact.
- + Used with Ø16 mm and Ø20 mm Low Density Polyethylene (LDPE) Pipes (Flat Drip Irrigation Pipe).
- + Used with Ø16 mm and Ø20 mm Drip Irrigation Circular Pipe.
- + They prevent alga and bacteria forming due to UV proof (ultraviolet beam) structure.
- + It has a homogeneous and non-porous inner surface.
- + It does not contain any harmful compounds which can change the taste or the smell of the water.



KULLANIM ALANLARI

- + Tarımsal Sulama
- + Peyzaj Sektörü
- + Seralar

INSTALLATION AREAS

- + Agricultural Irrigation
- + Landscaping Systems
- + Greenhouses

DAMLA SULAMA KURTAĞZI EK PARÇALAR / DRIPLINE BARBED FITTINGS

مواد التقطير شائكة / ФИТИНГИ РЕБРИСТЫЕ ДЛЯ КАПЕЛЬНОГО ОРОШЕНИЯ / زيانة شائكة سن خارج



KURTAĞZI NİPEL

BARBED NIPPLE
НИППЕЛЬ РЕБРИСТЫЙ
زيانة شائكة

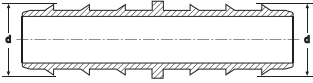

KOD CODE	EBAT / SIZE d x d	AMBALAJ ADEDİ PACKING QUANTITY	KOLİ ADEDİ BOX QUANTITY	ÇUVAL ADEDİ SACK QUANTITY
15122	16 x 16	100	3800	4000
15142	20 x 16	100	2200	2400
15144	20 x 20	100	2000	2000



KURTAĞZI - ERKEK NİPEL

BARBED - MALE NIPPLE
НИППЕЛЬ РЕБРИСТЫЙ - «ШТУЦЕР»
زيانة شائكة سن خارج

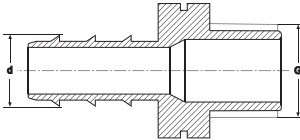

KOD CODE	EBAT / SIZE d x G	AMBALAJ ADEDİ PACKING QUANTITY	KOLİ ADEDİ BOX QUANTITY	ÇUVAL ADEDİ SACK QUANTITY
15221	16 x 1/2"	100	1800	2000
15222	16 x 3/4"	100	1600	1800
15241	20 x 1/2"	100	1500	1800
15242	20 x 3/4"	100	1400	1600
15252	25 x 3/4"	100	800	1000
15253	25 x 1"	100	800	900
15263	32 x 1"	100	600	600
15274	40 x 1 1/4"	50	300	350
15285	50 x 1 1/2"	25	200	250
15296	63 x 2"	15	120	150



KURTAĞZI TE

BARBED TEE
ТРОЙНИК РЕБРИСТЫЙ
تقسيم شائكة

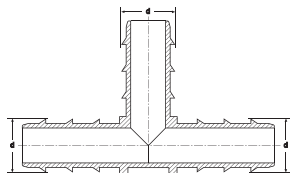

KOD CODE	EBAT / SIZE d x d x d	AMBALAJ ADEDİ PACKING QUANTITY	KOLİ ADEDİ BOX QUANTITY	ÇUVAL ADEDİ SACK QUANTITY
15322	16 x 16 x 16	100	1600	1800
15324	16 x 20 x 16	100	1300	1500
15342	20 x 16 x 20	100	900	1000
15344	20 x 20 x 20	100	800	900

DAMLA SULAMA KURTAĞZI EK PARÇALAR / DRIPLINE BARBED FITTINGS

KOD CODE	EBAT / SIZE d x G x d	AMBALAJ ADEDİ PACKING QUANTITY	KOLİ ADEDİ BOX QUANTITY	ÇUVAL ADEDİ SACK QUANTITY
15421	16 x ½" x 16	100	1500	1600
15422	16 x ¾" x 16	100	1200	1400
15441	20 x ½" x 20	100	900	1000
15442	20 x ¾" x 20	100	800	800
15443	20 x 1" x 20	100	600	700

KOD CODE	EBAT / SIZE d x c x d	AMBALAJ ADEDİ PACKING QUANTITY	KOLİ ADEDİ BOX QUANTITY	ÇUVAL ADEDİ SACK QUANTITY
15466	16 x 16 x 16	100	1400	1500
15468	16 x 20 x 16	100	1200	1200
15488	20 x 20 x 20	100	700	800

KOD CODE	EBAT / SIZE d x d	AMBALAJ ADEDİ PACKING QUANTITY	KOLİ ADEDİ BOX QUANTITY	ÇUVAL ADEDİ SACK QUANTITY
15522	16 x 16	100	2800	2800
15544	20 x 20	100	1600	1600



KURTAĞZI - ERKEK TE
BARBED - MALE TEE
ТРОЙНИК РЕБРИСТЫЙ - «ШТУЦЕР»
تقسيم شائكة سن خارج

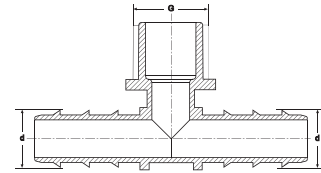

KURTAĞZI - GROMMET TE
BARBED - GROMMET TEE
ТРОЙНИК РЕБРИСТЫЙ - УПЛОТНИТЕЛЬНОЕ КОЛЬЦО
سن خارج

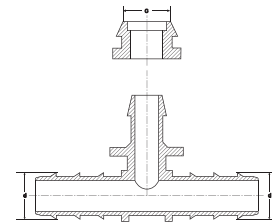

KURTAĞZI DİRSEK
BARBED ELBOW
КОЛЕНА РЕБРИСТОЕ
تقسيم شائكة مع حلقة تثبيت

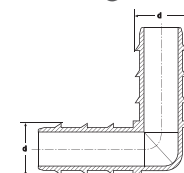

مواد التقطير شائكة / ФИТИНГИ РЕБРИСТЫЕ ДЛЯ КАПЕЛЬНОГО ОРОШЕНИЯ / ШАЙКА

DAMLA SULAMA KURTAĞZI EK PARÇALAR / DRIPLINE BARBED FITTINGS

مواد التقطير شائكة / ФИТИНГИ РЕБРИСТЫЕ ДЛЯ КАПЕЛЬНОГО ОРОШЕНИЯ /



KURTAĞZI - ERKEK DİRSEK

BARBED - MALE ELBOW
КОЛЕНО РЕБРИСТОЕ - «ШТУЦЕР»

عكس شائكة سن خارج

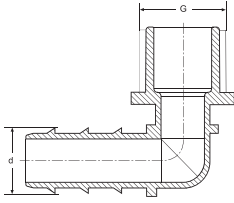

KOD CODE	EBAT / SIZE d x G	AMBALAJ ADEDİ PACKING QUANTITY	KOLİ ADEDİ BOX QUANTITY	ÇUVAL ADEDİ SACK QUANTITY
15621	16 x 1/2"	100	2200	2400
15622	16 x 3/4"	100	1800	2000
15641	20 x 1/2"	100	1600	1900
15642	20 x 3/4"	100	1300	1500



KURTAĞZI KÖR TAPA

BARBED END CAP
ЗАГЛУШКА РЕБРИСТАЯ

سدادة شائكة

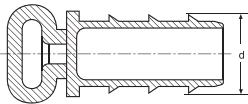

KOD CODE	EBAT / SIZE d	AMBALAJ ADEDİ PACKING QUANTITY	KOLİ ADEDİ BOX QUANTITY	ÇUVAL ADEDİ SACK QUANTITY
15722	16	100	5000	6000
15744	20	100	2800	3000



KURTAĞZI - GROMMET NİPEL

BARBED - GROMMET NIPPLE

НИППЕЛЬ РЕБРИСТЫЙ - УПЛОТНИТЕЛЬНОЕ

زبانة شائكة مع حلقة تثبيت

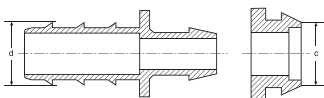

KOD CODE	EBAT / SIZE d x c	AMBALAJ ADEDİ PACKING QUANTITY	KOLİ ADEDİ BOX QUANTITY	ÇUVAL ADEDİ SACK QUANTITY
15822	16 x 16	100	2800	3000
15842	20 x 16	100	2400	2500

KOD CODE	EBAT / SIZE d	AMBALAJ ADEDİ PACKING QUANTITY	KOLİ ADEDİ BOX QUANTITY	ÇUVAL ADEDİ SACK QUANTITY
15966	16	100	4500	5000

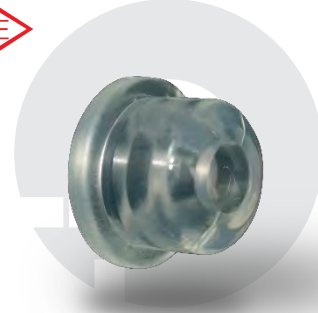

KURTAĞZI GROMMET CONTA
BARBED GROMMET GASKET
РЕБРИСТОЕ УПЛОТНИТЕЛЬНОЕ КОЛЬЦО
حلقة تثبيت شائكة

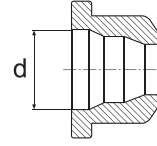

KOD CODE	EBAT SIZE-mm	AMBALAJ ADEDİ PACKING QUANTITY	KOLİ ADEDİ BOX QUANTITY	ÇUVAL ADEDİ SACK QUANTITY
16022	16	500	15000	17500
16044	20	500	10000	10000



BORU KELEPÇESİ
PIPE CLIP
ЗАЖИМ ДЛЯ ТРУБЫ
كاسية



KOD CODE	EBAT / SIZE d x G	AMBALAJ ADEDİ PACKING QUANTITY	KOLİ ADEDİ BOX QUANTITY	ÇUVAL ADEDİ SACK QUANTITY
15922	2 / 16 x 1"	25	650	750
15924	2 / 20 x 1"	25	450	500



KURTAĞZI ÇOKLU DAĞITIM NİPELİ
BARBED MULTICOUPLING NIPPLE
РАСПРЕДЕЛИТЕЛЬНЫЙ НИППЕЛЬ РЕБРИСТЫЙ
زبانه شائكة متعددة جهات

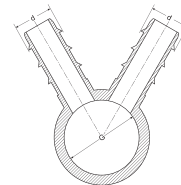



KURTAĞZI ÇOKLU DAĞITIM NİPELİ

BARBED MULTICOUPLING NIPPLE
РАСПРЕДЕЛИТЕЛЬНЫЙ НИППЕЛЬ РЕБРИСТЫЙ
زبانة شائكة متعددة جهات

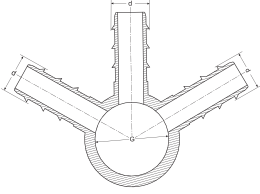

KOD CODE	EBAT / SIZE d x G	AMBALAJ ADEDİ PACKING QUANTITY	KOLİ ADEDİ BOX QUANTITY	ÇUVAL ADEDİ SACK QUANTITY
15932	3 / 16 x 1"	25	500	600
15934	3 / 20 x 1"	25	350	375



KURTAĞZI ÇOKLU DAĞITIM NİPELİ

BARBED MULTICOUPLING NIPPLE
РАСПРЕДЕЛИТЕЛЬНЫЙ НИППЕЛЬ РЕБРИСТЫЙ
زبانة شائكة متعددة جهات

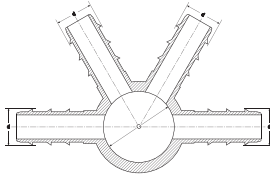

KOD CODE	EBAT / SIZE d x G	AMBALAJ ADEDİ PACKING QUANTITY	KOLİ ADEDİ BOX QUANTITY	ÇUVAL ADEDİ SACK QUANTITY
15942	4 / 16 x 1"	25	400	500
15944	4 / 20 x 1"	25	275	300



KURTAĞZI ÇOKLU DAĞITIM NİPELİ

BARBED MULTICOUPLING NIPPLE
РАСПРЕДЕЛИТЕЛЬНЫЙ НИППЕЛЬ РЕБРИСТЫЙ
زبانة شائكة متعددة جهات

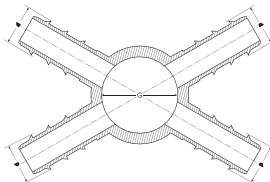

KOD CODE	EBAT / SIZE d x G	AMBALAJ ADEDİ PACKING QUANTITY	KOLİ ADEDİ BOX QUANTITY	ÇUVAL ADEDİ SACK QUANTITY
15945	4 x / 16 x 1"	25	400	400
15947	4 x / 20 x 1"	25	250	275

DAMLA SULAMA KURTAĞZI EK PARÇALAR / DRIFLINE BARBED FITTINGS

KOD CODE	EBAT / SIZE d x G	AMBALAJ ADEDİ PACKING QUANTITY	KOLİ ADEDİ BOX QUANTITY	ÇUVAL ADEDİ SACK QUANTITY
15962	6 / 16 x 1"	25	300	350
15964	6 / 20 x 1"	25	175	200

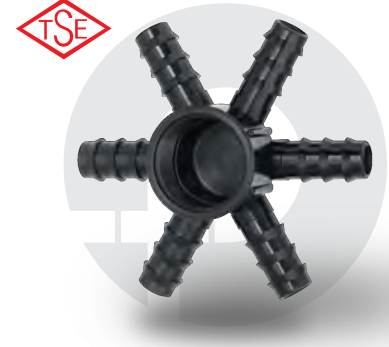

KURTAĞZI ÇOKLU DAĞITIM NİPELİ
BARBED MULTICOUPLING NIPPLE
РАСПРЕДЕЛИТЕЛЬНЫЙ НИППЕЛЬ РЕБРИСТЫЙ
زبانة شائكة متعددة جهات

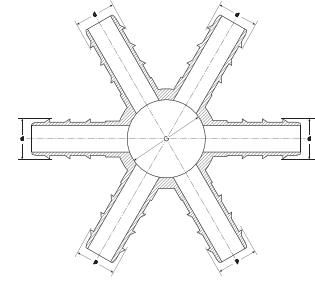

KOD CODE	DELİK ÇAPI EBAT / SIZE	AMBALAJ ADEDİ PACKING QUANTITY	KOLİ ADEDİ BOX QUANTITY	ÇUVAL ADEDİ SACK QUANTITY
16096	16	20	760	760
16098	20	20	660	660

Lütfen ürünlerin ambalaj bilgisi için [bkz: Sayfa 158](#)



BORU DELME APARATI
DRILLER
ДЫРОКОЛ ДЛЯ ТРУБ
ثاقبة

KOD CODE	DELİK ÇAPI EBAT / SIZE	AMBALAJ ADEDİ PACKING QUANTITY	KOLİ ADEDİ BOX QUANTITY	ÇUVAL ADEDİ SACK QUANTITY
16092	16	20	320	320
16094	20	20	300	320

Lütfen ürünlerin ambalaj bilgisi için [bkz: Sayfa 158](#)



BORU DELME EL APARATI
MANUEL DRILLER
ДЫРОКОЛ ДЛЯ ТРУБ
ثاقبة يدوية

مواد التقطير شائكة / ФИТИНГИ РЕБРИСТЫЕ ДЛЯ КАПЕЛЬНОГО ОРОШЕНИЯ/

DAMLA SULAMA KURTAĞZI EK PARÇALARI

DRIPLINE BARBED FITTINGS

ФИТИНГИ РЕБРИСТЫЕ ДЛЯ КАПЕЛЬНОГО ОРОШЕНИЯ

مواد التقطير شائكة

DİKKAT EDİLMESİ GEREKEN HUSUSLAR

- + Grommet Conta ile çıkış almak için kullanılacak Grommet Contalı ürün çeşidine göre delik çapı 16 mm veya 20 mm olacak şekilde boru delinmelidir.
- + Kurtağzı Grommet Conta ile çıkış almak için kullanılacak Kurtağzı Ek Parça çeşidine göre delik çapı 20 mm olacak şekilde boru delinmelidir.
- + Kurtağzı Ek Parçalar boruya takıldıktan sonra boru, Poelsan Boru Kelepçesi ile sıkıştırılmalıdır.

POINTS TO TAKE INTO CONSIDERATION

- + For a proper offtake with the Grommet Gasket, the pipe should be punched 16 mm or 20 mm according to the Grommet Gasket to be used.
- + For a proper offtake with the Barbed Grommet Gasket, the pipe should be punched 20 mm according to the Barbed Fitting to be used.
- + The pipe should be clamped with Poelsan Pipe Clip after the Barbed Fittings are installed to the pipe.

DAMLA SULAMA EK PARÇALARI

DRIPLINE FITTINGS

ФИТИНГИ ДЛЯ ТРУБЫ КАПЕЛЬНОГО ПОЛИВА

معدات تقطير

Özellikler

- + Darbelere karşı dayanıklı, yüksek kaliteli polipropilen hammaddeden üretilmiştir.
- + Ø16 mm ve Ø20 mm Yuvarlak Damla Sulama Borularında kullanılır.
- + UV ışınlarını geçirmediği için yosunlanmaya ve bakteri üremesine izin vermez.
- + İç yüzeyleri homojen ve gözeneksizdir.
- + Suyun kokusunu ve tadını değiştirebilecek zararlı bileşikler içermez.

Specifications

- + It has been produced from high quality polypropylene raw material and it has resistance to impact.
- + Used with Ø16 mm and Ø20 mm Drip Irrigation Circular Pipe.
- + They prevent alga and bacteria forming due to UV proof (ultraviolet beam) structure.
- + It has a homogeneous and non-porous inner surface.
- + It does not contain any harmful compounds which can change the taste or the smell of the water.

KULLANIM ALANLARI

- + Tarımsal Sulama
- + Peyzaj Sektörü
- + Seralar

INSTALLATION AREAS

- + Agricultural Irrigation
- + Landscaping Systems
- + Greenhouses



TS EN ISO 9261

DAMLAMA SULAMA EK PARÇALAR / DRIPLINE FITTINGS

معدات تقطير / FITTINGS FOR DRIPLINE TUBES



DAMLAMA NİPEL
DRIPLINE NIPPLE

НИППЕЛЬ ДЛЯ ТРУБЫ КАПЕЛЬНОГО ПОЛИВА
زبانه تقطير

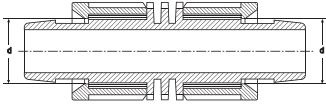

KOD CODE	EBAT / SIZE d x d	AMBALAJ ADEDİ PACKING QUANTITY	KOLİ ADEDİ BOX QUANTITY	ÇUVAL ADEDİ SACK QUANTITY
16122	16 x 16	100	1400	1500
16142	20 x 16	100	1100	1200
16144	20 x 20	100	1000	1000



DAMLAMA - ERKEK NİPEL
DRIPLINE - MALE NIPPLE

НИППЕЛЬ ДЛЯ ТРУБЫ КАПЕЛЬНОГО ПОЛИВА - «ШТУЦЕР»
زبانه تقطير سن خارج

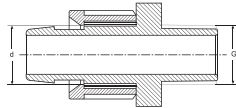

KOD CODE	EBAT / SIZE d x G	AMBALAJ ADEDİ PACKING QUANTITY	KOLİ ADEDİ BOX QUANTITY	ÇUVAL ADEDİ SACK QUANTITY
16221	16 x 1/2"	100	1700	1700
16222	16 x 3/4"	100	1500	1600
16241	20 x 1/2"	100	1300	1500
16242	20 x 3/4"	100	1200	1500

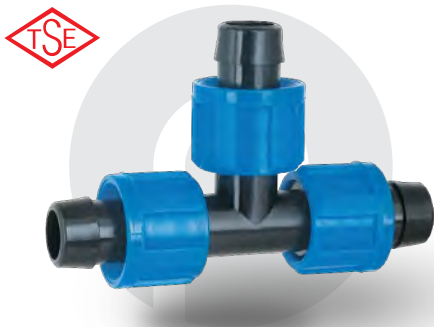

DAMLAMA TE
DRIPLINE TEE

ТРОЙНИК ДЛЯ ТРУБЫ КАПЕЛЬНОГО ПОЛИВА
تقسيم تقطير

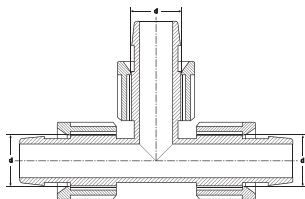

KOD CODE	EBAT / SIZE d x d x d	AMBALAJ ADEDİ PACKING QUANTITY	KOLİ ADEDİ BOX QUANTITY	ÇUVAL ADEDİ SACK QUANTITY
16322	16 x 16 x 16	100	800	900
16342	20 x 16 x 20	100	500	600
16344	20 x 20 x 20	100	500	500

DAMLA SULAMA EK PARÇALAR / DRIPLINE FITTINGS

KOD CODE	EBAT / SIZE d x G x d	AMBALAJ ADEDİ PACKING QUANTITY	KOLİ ADEDİ BOX QUANTITY	ÇUVAL ADEDİ SACK QUANTITY
16421	16 x 1/2" x 16	100	900	1000
16422	16 x 3/4" x 16	100	800	800
16441	20 x 1/2" x 20	100	600	600
16442	20 x 3/4" x 20	100	600	600
16443	20 x 1" x 20	100	400	500

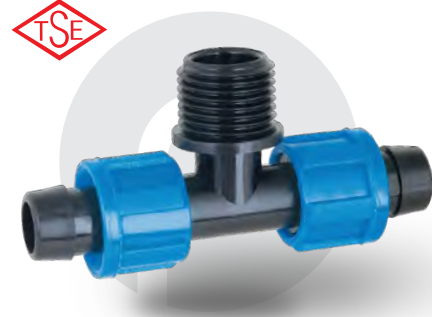

DAMLAMA - ERKEK TE

DRIPLINE - MALE TEE

ТРОЙНИК ДЛЯ ТРУБЫ КАПЕЛЬНОГО ПОЛИВА - «ШТУЦЕР»

تقسيم تقطير سن خارج

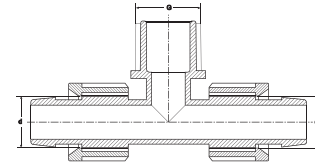

KOD CODE	EBAT / SIZE d x d	AMBALAJ ADEDİ PACKING QUANTITY	KOLİ ADEDİ BOX QUANTITY	ÇUVAL ADEDİ SACK QUANTITY
16522	16 x 16	100	1400	1400
16544	20 x 20	100	800	900



DAMLAMA DİRSEK

DRIPLINE ELBOW

КОЛЕНО ДЛЯ ТРУБЫ КАПЕЛЬНОГО ПОЛИВА

عكس تقطير

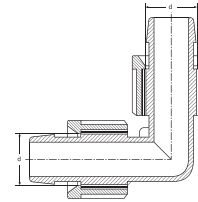

KOD CODE	EBAT / SIZE d x G	AMBALAJ ADEDİ PACKING QUANTITY	KOLİ ADEDİ BOX QUANTITY	ÇUVAL ADEDİ SACK QUANTITY
16621	16 x 1/2"	100	1600	1600
16622	16 x 3/4"	100	1400	1400
16641	20 x 1/2"	100	1100	1200
16642	20 x 3/4"	100	1000	1100



DAMLAMA - ERKEK DİRSEK

DRIPLINE - MALE ELBOW

КОЛЕНО ДЛЯ ТРУБЫ КАПЕЛЬНОГО ПОЛИВА - «ШТУЦЕР»

عكس تقطير سن خارج

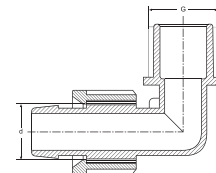

معدات تقطير / ФИТИНГИ ДЛЯ ТРУБЫ КАПЕЛЬНОГО ПОЛИВА

DAMLAMA SULAMA EK PARÇALAR / DRIPLINE FITTINGS

معدات تقطير / ФИТИНГИ ДЛЯ ТРУБЫ КАПЕЛЬНОГО ПОЛИВА



DAMLAMA KÖR TAPA

DRIPLINE END CAP

ЗАГЛУШКА ДЛЯ ТРУБЫ КАПЕЛЬНОГО ПОЛИВА

سدادة تقطير

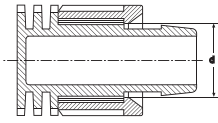

KOD CODE	EBAT / SIZE d	AMBALAJ ADEDİ PACKING QUANTITY	KOLİ ADEDİ BOX QUANTITY	ÇUVAL ADEDİ SACK QUANTITY
16722	16	100	2400	2500
16744	20	100	1600	1800



DAMLAMA - KURTAĞZI NİPEL

DRIPLINE - BARBED NIPPLE

НИППЕЛЬ ДЛЯ ТРУБЫ КАПЕЛЬНОГО ПОЛИВА - РЕБРИСТЫЙ

زبانة شائكة تقطير

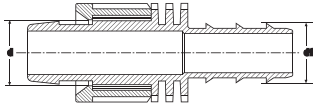

KOD CODE	EBAT / SIZE d x d ₁	AMBALAJ ADEDİ PACKING QUANTITY	KOLİ ADEDİ BOX QUANTITY	ÇUVAL ADEDİ SACK QUANTITY
16766	16 x 16	100	1800	1800
16788	20 x 20	100	1100	1300



DAMLAMA - GROMMET NİPEL

DRIPLINE - GROMMET NIPPLE

НИППЕЛЬ ДЛЯ ТРУБЫ КАПЕЛЬНОГО ПОЛИВА - УПЛОТНИТЕЛЬНОЕ КОЛЬЦО

زبانة مع حلقة تثبيت تقطير

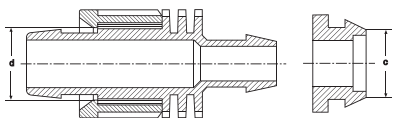

KOD CODE	EBAT / SIZE d x c	AMBALAJ ADEDİ PACKING QUANTITY	KOLİ ADEDİ BOX QUANTITY	ÇUVAL ADEDİ SACK QUANTITY
16822	16 x 16	100	1600	1800
16842	20 x 16	100	1200	1500
16844	20 x 20	100	1100	1200

DAMLA SULAMA EK PARÇALAR / DRIPLINE FITTINGS

معدات تقطير / ФИТИНГИ ДЛЯ ТРУБЫ КАПЕЛЬНОГО ПОЛИВА

KOD CODE	EBAT / SIZE d	AMBALAJ ADEDİ PACKING QUANTITY	KOLİ ADEDİ BOX QUANTITY	ÇUVAL ADEDİ SACK QUANTITY
16862	16	100	1300	1500
16884	20	100	1000	1200



DAMLAMA - CONTASIZ ÇIKIŞ NİPELİ

DRIPLINE - OFFTAKE NIPPLE WITHOUT GASKET
НИПЕЛЬ ДЛЯ ТРУБЫ КАПЕЛЬНОГО ПОЛИВА – ПОДЖИМ

زبانة قابلة للانفصال بدون حلقة تثبيت

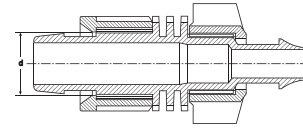

KOD CODE	EBAT SIZE-mm	AMBALAJ ADEDİ PACKING QUANTITY	KOLİ ADEDİ BOX QUANTITY	ÇUVAL ADEDİ SACK QUANTITY
16888	8	100	2200	2200



CONTASIZ ÇIKIŞ KÖR TAPA

OFFTAKE WITHOUT GASKET END CAP

КОНЦОВАЯ ЗАГЛУШКА БЕЗ ПРОКЛАДКИ

سدادة قابلة للانفصال مع حلقة تثبيت

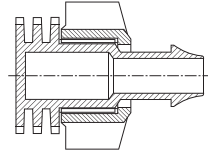

KOD CODE	EBAT SIZE-mm	AMBALAJ ADEDİ PACKING QUANTITY	KOLİ ADEDİ BOX QUANTITY	ÇUVAL ADEDİ SACK QUANTITY
16899	12	100	1200	1400



CONTASIZ ÇIKIŞ NİPELİ

OFFTAKE NIPPLE WITHOUT GASKET

НИПЕЛЬ С ПОДЖИМОМ

زبانة قابلة للانفصال بدون حلقة تثبيت

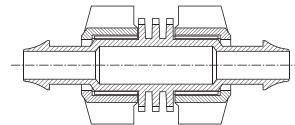

DAMLAMA SULAMA EK PARÇALAR / DRIPLINE FITTINGS

معدات تقطير / ФИТИНГИ ДЛЯ ТРУБЫ КАПЕЛЬНОГО ПОЛИВА



KOD CODE	EBAT / SIZE d x G	AMBALAJ ADEDİ PACKING QUANTITY	KOLİ ADEDİ BOX QUANTITY	ÇUVAL ADEDİ SACK QUANTITY
16922	2 / 16 x 1"	25	500	600
16924	2 / 20 x 1"	25	400	450

DAMLAMA ÇOKLU DAĞITIM NİPELİ

DRIPLINE MULTICOUPLING NIPPLE

РАСПРЕДЕЛИТЕЛЬНЫЙ НИППЕЛЬ ДЛЯ ТРУБЫ КАПЕЛЬНОГО ПОЛИВА

زبانه متعددة جهات تقطير

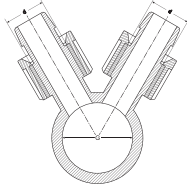

KOD CODE	EBAT / SIZE d x G	AMBALAJ ADEDİ PACKING QUANTITY	KOLİ ADEDİ BOX QUANTITY	ÇUVAL ADEDİ SACK QUANTITY
16932	3 / 16 x 1"	25	400	450
16934	3 / 20 x 1"	25	300	350

DAMLAMA ÇOKLU DAĞITIM NİPELİ

DRIPLINE MULTICOUPLING NIPPLE

РАСПРЕДЕЛИТЕЛЬНЫЙ НИППЕЛЬ ДЛЯ ТРУБЫ КАПЕЛЬНОГО ПОЛИВА

زبانه متعددة جهات تقطير

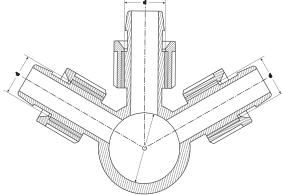

KOD CODE	EBAT / SIZE d x G	AMBALAJ ADEDİ PACKING QUANTITY	KOLİ ADEDİ BOX QUANTITY	ÇUVAL ADEDİ SACK QUANTITY
16942	4 / 16 x 1"	25	300	375
16944	4 / 20 x 1"	25	225	275

DAMLAMA ÇOKLU DAĞITIM NİPELİ

DRIPLINE MULTICOUPLING NIPPLE

РАСПРЕДЕЛИТЕЛЬНЫЙ НИППЕЛЬ ДЛЯ ТРУБЫ КАПЕЛЬНОГО ПОЛИВА

زبانه متعددة جهات تقطير

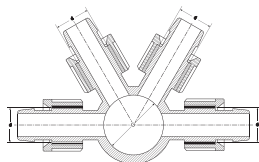

DAMLA SULAMA EK PARÇALAR / DRIPLINE FITTINGS

KOD CODE	EBAT / SIZE d x G	AMBALAJ ADEDİ PACKING QUANTITY	KOLİ ADEDİ BOX QUANTITY	ÇUVAL ADEDİ SACK QUANTITY
16945	4 x / 16 x 1"	25	300	375
16947	4 x / 20 x 1"	25	200	250



DAMLAMA ÇOKLU DAĞITIM NİPELİ

DRIPLINE MULTICOUPLING NIPPLE
РАСПРЕДЕЛИТЕЛЬНЫЙ НИППЕЛЬ ДЛЯ ТРУБЫ КАПЕЛЬНОГО ПОЛИВА
زبانه متعددة جهات تقطير

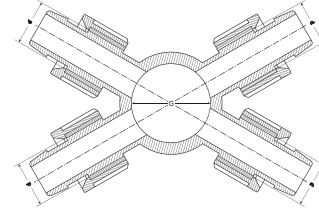

KOD CODE	EBAT / SIZE d x G	AMBALAJ ADEDİ PACKING QUANTITY	KOLİ ADEDİ BOX QUANTITY	ÇUVAL ADEDİ SACK QUANTITY
16962	6 / 16 x 1"	25	225	250
16964	6 / 20 x 1"	25	150	175



DAMLAMA ÇOKLU DAĞITIM NİPELİ

DRIPLINE MULTICOUPLING NIPPLE
РАСПРЕДЕЛИТЕЛЬНЫЙ НИППЕЛЬ ДЛЯ ТРУБЫ КАПЕЛЬНОГО ПОЛИВА
زبانه متعددة جهات تقطير

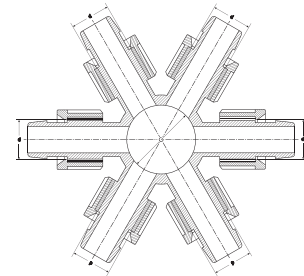

معدات تقطير / ФИТИНГИ ДЛЯ ТРУБЫ КАПЕЛЬНОГО ПОЛИВА

DAMLA SULAMA EK PARÇALARI

DRIPLINE FITTINGS

ФИТИНГИ ДЛЯ ТРУБЫ КАПЕЛЬНОГО ПОЛИВА

معدات تقطير

DİKKAT EDİLMESİ GEREKEN HUSUSLAR

- + Grommet Conta ile çıkış almak için kullanılacak grommet contalı ürün çeşidine göre delik çapı 16 mm veya 20 mm olacak şekilde boru delinmelidir.
- + Contasız Çıkış, Layflat ve Alçak Yoğunluklu Polietilen (AYPE) Borulardan (Düz Damla Sulama Borusu), Ø16 mm ve Ø20 mm Damla Sulama Borularına çıkış almak için kullanılır. Contasız Çıkış Ucu ile çıkış almak için boru, delik çapı 8 mm olacak şekilde delinmelidir.
- + Contasız Çıkış Nipelü ürün, Layflat Borulardan, Ø12 mm Spagetti Borulara çıkış almak için kullanılır. Contasız Çıkış Ucu ile çıkış almak için boru, delik çapı 8 mm olacak şekilde delinmelidir.

POINTS TO TAKE INTO CONSIDERATION

- + For a proper offtake with the Grommet Gasket, the pipe should be punched 16 mm or 20 mm according to the grommet gasket to be used.
- + The items with offtake without gasket are used for joining the Layflat and Low Density Polyethylene (LDPE) Pipes (Flat Drip Irrigation Pipe) With Drip Irrigation Pipe (Ø16 mm & Ø20 mm). For a proper offtake, the pipe should be punched 8 mm.
- + The Offtake Nipple item is used for joining the Layflat Pipes with Ø12 mm Microtube Pipes. For a proper offtake, the pipe should be punched 8 mm.

YASSI DAMLA SULAMA EK PARÇALARI

DRIP TAPE FITTINGS

ФИТИНГИ ДЛЯ КАПЕЛЬНОЙ ЛЕНТЫ

معدات قطرة الشريطية

Özellikler

- + Darbelere karşı dayanıklı, yüksek kaliteli polipropilen hammaddeden üretilmiştir.
- + Ø17 mm ve Ø22 mm Yassı Damla Sulama Borularında kullanılır.
- + UV ışınlarını geçirmediği için yosunlanmaya ve bakteri üremesine izin vermez.
- + İç yüzeyleri homojen ve gözeneksizdir.
- + Suyun kokusunu ve tadını değiştirebilecek zararlı bileşikler içermez.

Specifications

- + It has been produced from high quality polypropylene raw material and it has resistance to impact.
- + Used with Ø17 mm and Ø22 mm Tape Driplines.
- + They prevent alga and bacteria forming due to UV proof (ultraviolet beam) structure.
- + It has a homogeneous and non-porous inner surface.
- + It does not contain any harmful compounds which can change the taste or the smell of the water.



KULLANIM ALANLARI

- + Tarımsal Sulama
- + Peyzaj Sektörü
- + Seralar

INSTALLATION AREAS

- + Agricultural Irrigation
- + Landscaping Systems
- + Greenhouses

YASSI DAMLA SULAMA EK PARÇALAR / DRIP TAPE FITTINGS

معدات فطرة الشريطية / ФИТИНГИ ДЛЯ КАПЕЛЬНОЙ ЛЕНТЫ



YASSI NİPEL

TAPE NIPPLE

РАСПРЕДЕЛИТЕЛЬНЫЙ НИППЕЛЬ ДЛЯ КАПЕЛЬНОЙ ЛЕНТЫ

زبانة شريطية

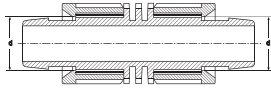

KOD CODE	EBAT / SIZE d x d	AMBALAJ ADEDİ PACKING QUANTITY	KOLİ ADEDİ BOX QUANTITY	ÇUVAL ADEDİ SACK QUANTITY
17122	17 x 17	100	1400	1600
17144	22 x 22	100	600	800
17155	25 x 25	100	500	600



YASSI - ERKEK NİPEL

TAPE - MALE NIPPLE

НИПЕЛЬ КАПЕЛЬНАЯ ЛЕНТА - «ШТУЦЕР»

زبانة شريطية سن خارج

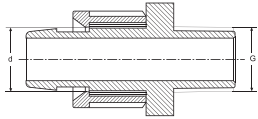

KOD CODE	EBAT / SIZE d x G	AMBALAJ ADEDİ PACKING QUANTITY	KOLİ ADEDİ BOX QUANTITY	ÇUVAL ADEDİ SACK QUANTITY
17221	17 x 1/2"	100	1600	1700
17222	17 x 3/4"	100	1400	1700
17242	22 x 3/4"	100	1000	1200
17252	25 x 3/4"	100	700	800

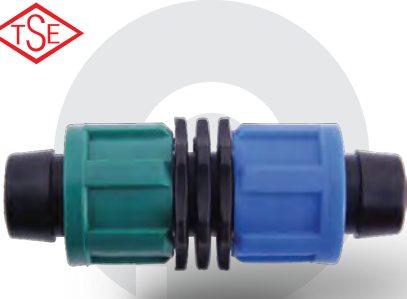

YASSI - DAMLAMA NİPEL

TAPE - DRIPLINE NIPPLE

НИПЕЛЬ КАПЕЛЬНАЯ ЛЕНТА - ДЛЯ ТРУБЫ КАПЕЛЬНОГО ПОЛИВА

زبانة تقطير شريطية

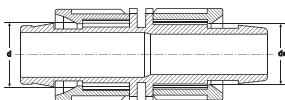

KOD CODE	EBAT / SIZE d x d ₁	AMBALAJ ADEDİ PACKING QUANTITY	KOLİ ADEDİ BOX QUANTITY	ÇUVAL ADEDİ SACK QUANTITY
17322	17 x 16	100	1400	1500
17344	22 x 20	100	700	800
17354	25 x 20	100	600	700

YASSI DAMLA SULAMA EK PARÇALAR / DRIP TAPE FITTINGS

KOD CODE	EBAT / SIZE d x d ₁	AMBALAJ ADEDİ PACKING QUANTITY	KOLİ ADEDİ BOX QUANTITY	ÇUVAL ADEDİ SACK QUANTITY
17422	17 x 16	100	1600	1800
17444	22 x 20	100	700	1000
17454	25 x 20	100	600	800



YASSI - KURTAĞZI NİPEL

TAPE - BARBED NIPPLE
НИПЕЛЬ КАПЕЛЬНАЯ ЛЕНТА – РЕБРИСТЫЙ
زیانة شائكة شريطية

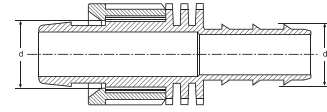

KOD CODE	EBAT / SIZE d x c	AMBALAJ ADEDİ PACKING QUANTITY	KOLİ ADEDİ BOX QUANTITY	ÇUVAL ADEDİ SACK QUANTITY
17522	17 x 16	100	1600	1800
17544	22 x 20	100	800	1000



YASSI - GROMMET NİPEL

TAPE - GROMMET NIPPLE
НИПЕЛЬ КАПЕЛЬНАЯ ЛЕНТА – УПЛОТНИТЕЛЬНОЕ КОЛЬЦО
زیانة مع حلقة تثبيت شريطية

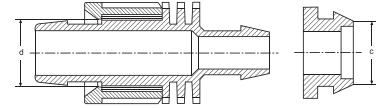

KOD CODE	EBAT / SIZE d	AMBALAJ ADEDİ PACKING QUANTITY	KOLİ ADEDİ BOX QUANTITY	ÇUVAL ADEDİ SACK QUANTITY
17562	17	100	1200	1500
17584	22	100	800	1000



YASSI - CONTASIZ ÇIKIŞ NİPELİ

TAPE - OFFTAKE NIPPLE WITHOUT GASKET
НИПЕЛЬ КАПЕЛЬНАЯ ЛЕНТА – ПОДЖИМ
زیانة قابلة للانفصال بدون حلقة تثبيت شريطية

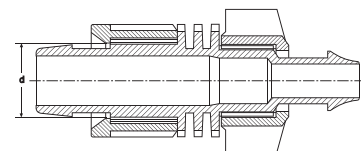

معدات فطرة الشريطية / ФИТИНГИ ДЛЯ КАПЕЛЬНОЙ ЛЕНТЫ

YASSI DAMLA SULAMA EK PARÇALAR / DRIP TAPE FITTINGS

معدات فطرة الشريطية / ФИТИНГИ ДЛЯ КАПЕЛЬНОЙ ЛЕНТЫ



YASSI TE

TAPE TEE

ТРОЙНИК ДЛЯ КАПЕЛЬНОЙ ЛЕНТЫ

تقسيم شريطية

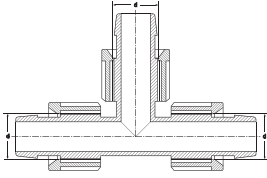

KOD CODE	EBAT / SIZE d x d x d	AMBALAJ ADEDİ PACKING QUANTITY	KOLİ ADEDİ BOX QUANTITY	ÇUVAL ADEDİ SACK QUANTITY
17622	17 x 17 x 17	100	800	900
17655	25 x 25 x 25	50	300	300



YASSI - ERKEK TE

TAPE - MALE TEE

ТРОЙНИК КАПЕЛЬНАЯ ЛЕНТА - «ШТУЦЕР»

تقسيم سن خارج شريطية

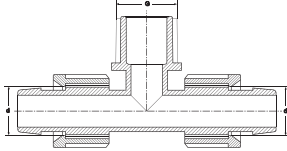

KOD CODE	EBAT / SIZE d x G x d	AMBALAJ ADEDİ PACKING QUANTITY	KOLİ ADEDİ BOX QUANTITY	ÇUVAL ADEDİ SACK QUANTITY
17721	17 x 1/2" x 17	100	800	1000
17722	17 x 3/4" x 17	100	800	800
17723	17 x 1" x 17	100	600	700
17751	25 x 1/2" x 25	50	400	400
17752	25 x 3/4" x 25	50	300	350
17753	25 x 1" x 25	50	300	350



YASSI DİRSEK

TAPE ELBOW

КОЛЕНО ДЛЯ КАПЕЛЬНОЙ ЛЕНТЫ

عكس شريطية

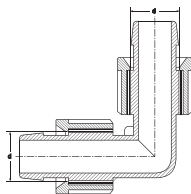

KOD CODE	EBAT / SIZE d x d	AMBALAJ ADEDİ PACKING QUANTITY	KOLİ ADEDİ BOX QUANTITY	ÇUVAL ADEDİ SACK QUANTITY
17822	17 x 17	100	1400	1400
17855	25 x 25	100	400	600

YASSI DAMLA SULAMA EK PARÇALAR / DRIP TAPE FITTINGS

KOD CODE	EBAT / SIZE d x G	AMBALAJ ADEDİ PACKING QUANTITY	KOLİ ADEDİ BOX QUANTITY	ÇUVAL ADEDİ SACK QUANTITY
17921	17 x ½"	100	1600	1600
17922	17 x ¾"	100	1200	1300
17951	25 x ½"	100	600	700
17952	25 x ¾"	100	600	700
17953	25 x 1"	100	500	600



YASSI - ERKEK DİRSEK

TAPE - MALE ELBOW
КОЛЕНА КАПЕЛЬНАЯ ЛЕНТА - «ШТУЦЕР»
عكس سن خارج شريطية

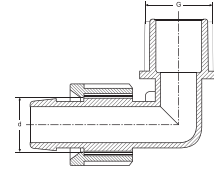

KOD CODE	EBAT / SIZE d	AMBALAJ ADEDİ PACKING QUANTITY	KOLİ ADEDİ BOX QUANTITY	ÇUVAL ADEDİ SACK QUANTITY
18022	17	100	2400	2700
18044	22	100	1200	1400
18055	25	100	1000	1000



YASSI KÖR TAPA

TAPE END CAP
ЗАГЛУШКА ДЛЯ КАПЕЛЬНОЙ ЛЕНТЫ
سدادة شريطية

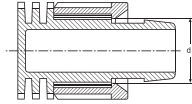

KOD CODE	EBAT / SIZE d x G	AMBALAJ ADEDİ PACKING QUANTITY	KOLİ ADEDİ BOX QUANTITY	ÇUVAL ADEDİ SACK QUANTITY
18122	2 / 17 x 1"	25	500	600
18124	2 / 22 x 1"	25	350	400
18125	2 / 25 x 1"	25	300	325



YASSI DAMLAMA ÇOKLU DAĞITIM NİPELİ

TAPE MULTICOUPLING NIPPLE
РАСПРЕДЕЛИТЕЛЬНЫЙ НИППЕЛЬ ДЛЯ КАПЕЛЬНОЙ ЛЕНТЫ
زبانه متعددة جهات شريطية

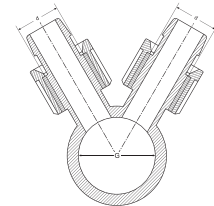

معدات قطرة الشريطية / ФИТИНГИ ДЛЯ КАПЕЛЬНОЙ ЛЕНТЫ

YASSI DAMLA SULAMA EK PARÇALAR / DRIP TAPE FITTINGS

معدات قطرة الشريطية / ФИТИНГИ ДЛЯ КАПЕЛЬНОЙ ЛЕНТЫ



YASSI DAMLAMA ÇOKLU DAĞITIM NİPELİ

TAPE MULTICOUPLING NIPPLE

РАСПРЕДЕЛИТЕЛЬНЫЙ НИППЕЛЬ ДЛЯ КАПЕЛЬНОЙ ЛЕНТЫ

زبانة متعددة جهات شريطية

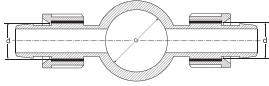

KOD CODE	EBAT / SIZE d x G	AMBALAJ ADEDİ PACKING QUANTITY	KOLİ ADEDİ BOX QUANTITY	ÇUVAL ADEDİ SACK QUANTITY
18127	2 / 22 x 1"	25	300	375



YASSI DAMLAMA ÇOKLU DAĞITIM NİPELİ

TAPE MULTICOUPLING NIPPLE

РАСПРЕДЕЛИТЕЛЬНЫЙ НИППЕЛЬ ДЛЯ КАПЕЛЬНОЙ ЛЕНТЫ

زبانة متعددة جهات شريطية

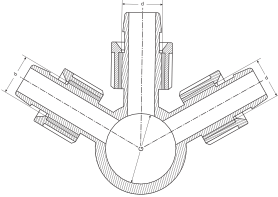

KOD CODE	EBAT / SIZE d x G	AMBALAJ ADEDİ PACKING QUANTITY	KOLİ ADEDİ BOX QUANTITY	ÇUVAL ADEDİ SACK QUANTITY
18132	3 / 17 x 1"	25	400	500
18134	3 / 22 x 1"	25	250	300
18135	3 / 25 x 1"	25	200	250



YASSI DAMLAMA ÇOKLU DAĞITIM NİPELİ

TAPE MULTICOUPLING NIPPLE

РАСПРЕДЕЛИТЕЛЬНЫЙ НИППЕЛЬ ДЛЯ КАПЕЛЬНОЙ ЛЕНТЫ

زبانة متعددة جهات شريطية

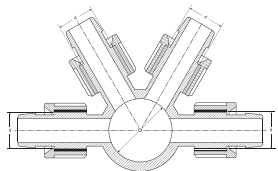

KOD CODE	EBAT / SIZE d x G	AMBALAJ ADEDİ PACKING QUANTITY	KOLİ ADEDİ BOX QUANTITY	ÇUVAL ADEDİ SACK QUANTITY
18142	4 / 17 x 1"	25	300	400
18144	4 / 22 x 1"	25	200	200
181444	4 / 25 x 1"	25	150	175

YASSI DAMLA SULAMA EK PARÇALAR / DRIP TAPE FITTINGS

KOD CODE	EBAT / SIZE d x G	AMBALAJ ADEDİ PACKING QUANTITY	KOLİ ADEDİ BOX QUANTITY	ÇUVAL ADEDİ SACK QUANTITY
18145	4 x / 17 x 1"	25	350	375
18147	4 x / 22 x 1"	25	175	200
18148	4 x / 25 x 1"	25	150	175



YASSI DAMLAMA ÇOKLU DAĞITIM NİPELİ

TAPE MULTICOUPLING NIPPLE
 РАСПРЕДЕЛИТЕЛЬНЫЙ НИППЕЛЬ ДЛЯ КАПЕЛЬНОЙ ЛЕНТЫ
 زبانة متعددة جهات شريطية

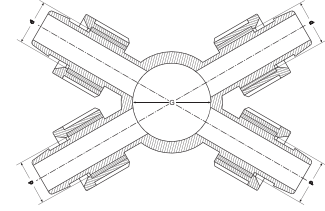

KOD CODE	EBAT / SIZE d x G	AMBALAJ ADEDİ PACKING QUANTITY	KOLİ ADEDİ BOX QUANTITY	ÇUVAL ADEDİ SACK QUANTITY
18162	6 / 17 x 1"	25	250	300
18164	6 / 22 x 1"	25	100	150
18165	6 / 25 x 1"	25	100	125



YASSI DAMLAMA ÇOKLU DAĞITIM NİPELİ

TAPE MULTICOUPLING NIPPLE
 РАСПРЕДЕЛИТЕЛЬНЫЙ НИППЕЛЬ ДЛЯ КАПЕЛЬНОЙ ЛЕНТЫ
 زبانة متعددة جهات شريطية

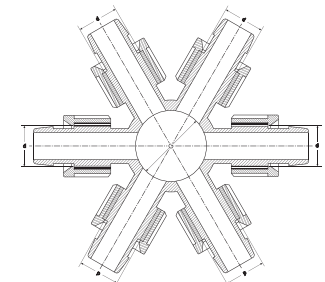

معدات فطرة الشريطية / ФИТИНГИ ДЛЯ КАПЕЛЬНОЙ ЛЕНТЫ

YASSI DAMLA SULAMA EK PARÇALARI

DRIP TAPE FITTINGS

ФИТИНГИ ДЛЯ КАПЕЛЬНОЙ ЛЕНТЫ

معدات قطرة الشريطية

DİKKAT EDİLMESİ GEREKEN HUSUSLAR

- + Grommet Conta ile çıkış almak için kullanılacak grommet contalı ürün çeşidine göre delik çapı 16 mm veya 20 mm olacak şekilde boru delinmelidir.
- + Contasız Çıkış, Layflat ve Alçak Yoğunluklu Polietilen (AYPE) Borulardan (Düz Damla Sulama Borusu), Ø17 mm ve Ø22 mm Yassı Damla Sulama Borularına çıkış almak için kullanılır. Contasız Çıkış Ucu ile çıkış almak için boru, delik çapı 8 mm olacak şekilde delinmelidir.

POINTS TO TAKE INTO CONSIDERATION

- + For a proper offtake with the Grommet Gasket, the pipe should be punched 16 mm or 20 mm according to the Grommet Gasket to be used.
- + The items with offtake without gasket are used for joining the Layflat and Low Density Polyethylene (LDPE) Pipes (Flat Drip Irrigation Pipe) with Flat Drip Irrigation Pipe Ø17 mm & Ø22 mm. For a proper offtake, the pipe should be punched 8 mm.

YÜZÜKLÜ YASSI DAMLA SULAMA EK PARÇALARI

DRIP TAPE FITTINGS WITH RING

ФИТИНГИ ДЛЯ КАПЕЛЬНОЙ ЛЕНТЫ С КОЛЬЦОМ

معدات قطرة شريطية مع الحلقة

Özellikler

- + Darbelere karşı dayanıklı, yüksek kaliteli polipropilen hammaddeden üretilmiştir.
- + Ø17 mm dikişsiz Yassı Damla Sulama Borularında kullanılır.
- + UV ışınlarını geçirmediği için yosunlanmaya ve bakteri üremesine izin vermez.
- + İç yüzeyleri homojen ve gözeneksizdir.
- + Suyun kokusunu ve tadını değiştirebilecek zararlı bileşikler içermez.

Specifications

- + It has been produced from high quality polypropylene raw material and it has resistance to impact.
- + Used with seamless Ø17 mm Tape Driplines.
- + They prevent alga and bacteria forming due to UV proof (ultraviolet beam) structure.
- + It has a homogeneous and non-porous inner surface.
- + It does not contain any harmful compounds which can change the taste or the smell of the water.

KULLANIM ALANLARI

- + Tarımsal Sulama
- + Peyzaj Sektörü
- + Seralar

INSTALLATION AREAS

- + Agricultural Irrigation
- + Landscaping Systems
- + Greenhouses



TS EN ISO 9261



YÜZÜKLÜ YASSI NİPEL

TAPE (WITH RING) NIPPLE
НИППЕЛЬ С КОЛЬЦОМ ДЛЯ КАПЕЛЬНОЙ ЛЕНТЫ
زبانة (مع الحلقة) شريطية

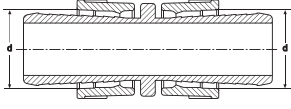

KOD CODE	EBAT / SIZE d x d	AMBALAJ ADEDİ PACKING QUANTITY	KOLİ ADEDİ BOX QUANTITY	ÇUVAL ADEDİ SACK QUANTITY
18522	17 x 17	100	2500	2500



YÜZÜKLÜ YASSI - ERKEK NİPEL

TAPE (WITH RING) - MALE NIPPLE
НИППЕЛЬ С КОЛЬЦОМ КАПЕЛЬНАЯ ЛЕНТА - «ШТУЦЕР»
زبانة سن خارج (مع الحلقة) شريطية

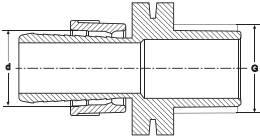

KOD CODE	EBAT / SIZE d x G	AMBALAJ ADEDİ PACKING QUANTITY	KOLİ ADEDİ BOX QUANTITY	ÇUVAL ADEDİ SACK QUANTITY
18621	17 x ½"	100	1600	1800
18622	17 x ¾"	100	1600	1700



YÜZÜKLÜ YASSI - KURTAĞZI NİPEL

TAPE (WITH RING) - BARBED NIPPLE
НИППЕЛЬ С КОЛЬЦОМ КАПЕЛЬНАЯ ЛЕНТА - РЕБРИСТЫЙ
زبانة شائكة (مع الحلقة) شريطية

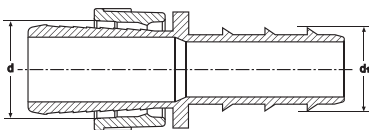

KOD CODE	EBAT / SIZE d x d ₁	AMBALAJ ADEDİ PACKING QUANTITY	KOLİ ADEDİ BOX QUANTITY	ÇUVAL ADEDİ SACK QUANTITY
18822	17 x 16	100	2800	3000

YÜZÜKLÜ YASSI DAMLA SULAMA EK PARÇALAR / DRIP TAPE FITTINGS WITH RING

معدات فطرة شريطية مع الحلقة / ФИТИНГИ ДЛЯ КАПЕЛЬНОЙ ЛЕНТЫ С КОЛЬЦОМ /

KOD CODE	EBAT / SIZE d x c	AMBALAJ ADEDİ PACKING QUANTITY	KOLİ ADEDİ BOX QUANTITY	ÇUVAL ADEDİ SACK QUANTITY
18922	17 x 16	100	2600	2500



YÜZÜKLÜ YASSI - GROMMET NİPEL

TAPE (WITH RING) - GROMMET NIPPLE
НИПЕЛЬ С КОЛЬЦОМ КАПЕЛЬНАЯ ЛЕНТА - УПЛОТНИТЕЛЬНОЕ КОЛЬЦО
زیانه مع حلقة تثبیت (مع الحلقة) شريطية

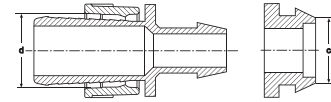

KOD CODE	EBAT / SIZE d x d x d	AMBALAJ ADEDİ PACKING QUANTITY	KOLİ ADEDİ BOX QUANTITY	ÇUVAL ADEDİ SACK QUANTITY
19022	17 x 17 x 17	100	1300	1300



YÜZÜKLÜ YASSI TE

TAPE (WITH RING) TEE
ТРОЙНИК С КОЛЬЦОМ ДЛЯ КАПЕЛЬНОЙ ЛЕНТЫ
تقسیم (مع الحلقة) شريطية

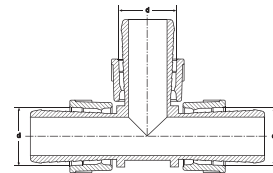

KOD CODE	EBAT / SIZE d x G x d	AMBALAJ ADEDİ PACKING QUANTITY	KOLİ ADEDİ BOX QUANTITY	ÇUVAL ADEDİ SACK QUANTITY
19121	17 x 1/2" x 17	100	1200	1500
19122	17 x 3/4" x 17	100	1000	1000
19123	17 x 1" x 17	100	900	800



YÜZÜKLÜ YASSI - ERKEK TE

TAPE (WITH RING) - MALE TEE
ТРОЙНИК (С КОЛЬЦОМ) КАПЕЛЬНАЯ ЛЕНТА - «ШТУЦЕР»
تقسیم سن خارج (مع الحلقة) شريطية

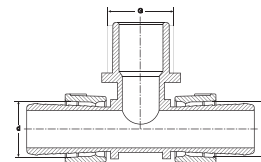

YÜZÜKLÜ YASSI DAMLA SULAMA EK PARÇALAR / DRIP TAPE FITTINGS WITH RING

مععدات فطرة شريطية مع الحلقة / ФИТИНГИ ДЛЯ КАПЕЛЬНОЙ ЛЕНТЫ С КОЛЬЦОМ



YÜZÜKLÜ YASSI DİRSEK

TAPE (WITH RING) ELBOW
КОЛЕНО (С КОЛЬЦОМ) ДЛЯ КАПЕЛЬНОЙ ЛЕНТЫ
عكس (مع الحلقة) شريطية

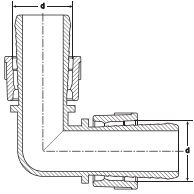

KOD CODE	EBAT / SIZE d x d	AMBALAJ ADEDİ PACKING QUANTITY	KOLİ ADEDİ BOX QUANTITY	ÇUVAL ADEDİ SACK QUANTITY
19222	17 x 17	100	1800	2000



YÜZÜKLÜ YASSI - ERKEK DİRSEK

TAPE (WITH RING) - MALE ELBOW
КОЛЕНО (С КОЛЬЦОМ) КАПЕЛЬНАЯ ЛЕНТА - «ШТУЦЕР»
عكس سن خارج (مع الحلقة) شريطية

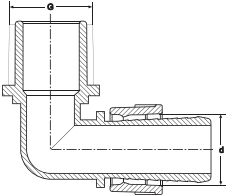

KOD CODE	EBAT / SIZE d x G	AMBALAJ ADEDİ PACKING QUANTITY	KOLİ ADEDİ BOX QUANTITY	ÇUVAL ADEDİ SACK QUANTITY
19321	17 x 1/2"	100	1800	1800
19322	17 x 3/4"	100	1400	1500



YÜZÜKLÜ YASSI KÖR TAPA

TAPE (WITH RING) END CAP
ЗАГЛУШКА (С КОЛЬЦОМ) ДЛЯ КАПЕЛЬНОЙ ЛЕНТЫ
سدادة (مع الحلقة) شريطية

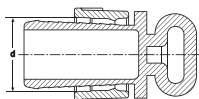

KOD CODE	EBAT / SIZE d	AMBALAJ ADEDİ PACKING QUANTITY	KOLİ ADEDİ BOX QUANTITY	ÇUVAL ADEDİ SACK QUANTITY
19422	17	100	4000	4000

KOD CODE	EBAT / SIZE d x G	AMBALAJ ADEDİ PACKING QUANTITY	KOLİ ADEDİ BOX QUANTITY	ÇUVAL ADEDİ SACK QUANTITY
19522	2 / 17 x 1"	25	600	650



YÜZÜKLÜ YASSI ÇOKLU DAĞITIM NİPELİ

TAPE (WITH RING) MULTICOUPLING NIPPLE
ЗАГЛУШКА (С КОЛЬЦОМ) ДЛЯ КАПЕЛЬНОЙ ЛЕНТЫ
زبانة متعددة جهات (مع الحلقة) شريطية

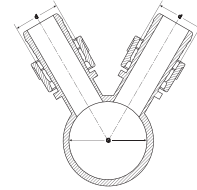

KOD CODE	EBAT / SIZE d x G	AMBALAJ ADEDİ PACKING QUANTITY	KOLİ ADEDİ BOX QUANTITY	ÇUVAL ADEDİ SACK QUANTITY
19532	3 / 17 x 1"	25	500	500



YÜZÜKLÜ YASSI ÇOKLU DAĞITIM NİPELİ

TAPE (WITH RING) MULTICOUPLING NIPPLE
ЗАГЛУШКА (С КОЛЬЦОМ) ДЛЯ КАПЕЛЬНОЙ ЛЕНТЫ
زبانة متعددة جهات (مع الحلقة) شريطية

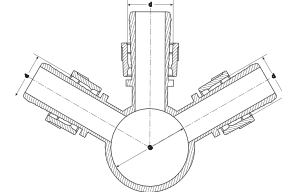

KOD CODE	EBAT / SIZE d x G	AMBALAJ ADEDİ PACKING QUANTITY	KOLİ ADEDİ BOX QUANTITY	ÇUVAL ADEDİ SACK QUANTITY
19542	4 / 17 x 1"	25	400	450



YÜZÜKLÜ YASSI ÇOKLU DAĞITIM NİPELİ

TAPE (WITH RING) MULTICOUPLING NIPPLE
ЗАГЛУШКА (С КОЛЬЦОМ) ДЛЯ КАПЕЛЬНОЙ ЛЕНТЫ
زبانة متعددة جهات (مع الحلقة) شريطية

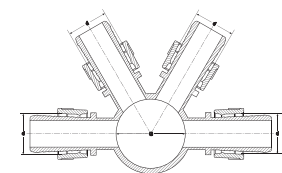



KOD CODE	EBAT / SIZE d x G	AMBALAJ ADEDİ PACKING QUANTITY	KOLİ ADEDİ BOX QUANTITY	ÇUVAL ADEDİ SACK QUANTITY
19545	4 x / 17 x 1"	25	375	400

YÜZÜKLÜ YASSI ÇOKLU DAĞITIM NİPELİ

TAPE (WITH RING) MULTICOUPLING NIPPLE
ЗАГЛУШКА (С КОЛЬЦОМ) ДЛЯ КАПЕЛЬНОЙ ЛЕНТЫ
زبانة متعددة جهات (مع الحلقة) شريطية

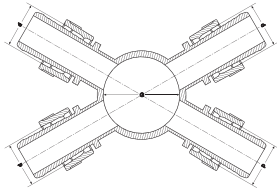

KOD CODE	EBAT / SIZE d x G	AMBALAJ ADEDİ PACKING QUANTITY	KOLİ ADEDİ BOX QUANTITY	ÇUVAL ADEDİ SACK QUANTITY
19562	6 / 17 x 1"	25	275	300

YÜZÜKLÜ YASSI ÇOKLU DAĞITIM NİPELİ

TAPE (WITH RING) MULTICOUPLING NIPPLE
ЗАГЛУШКА (С КОЛЬЦОМ) ДЛЯ КАПЕЛЬНОЙ ЛЕНТЫ
زبانة متعددة جهات (مع الحلقة) شريطية

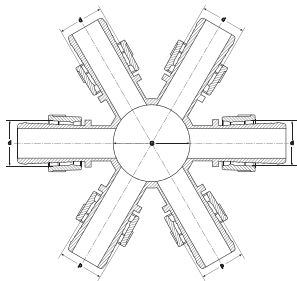

YÜZÜKLÜ YASSI DAMLA SULAMA EK PARÇALARI

DRIP TAPE FITTINGS WITH RING
ФИТИНГИ ДЛЯ КАПЕЛЬНОЙ ЛЕНТЫ С КОЛЬЦОМ
معدات قطرة شريطية مع الحلقة

DİKKAT EDİLMESİ GEREKEN HUSUSLAR

- + Grommet Conta ile çıkış almak için kullanılacak grommet contalı ürün çeşidine göre delik çapı 16 mm olacak şekilde boru delinmelidir.

POINTS TO TAKE INTO CONSIDERATION

- + For a proper offtake with the Grommet Gasket, the pipe should be punched 16 mm according to the Grommet Gasket to be used.

MINİSPRİNKLER & MİKROFİTİNGLER

MINİSPRINKLERS & MICROFITTINGS

МИНИСПРИНКЛЕРЫ И МИКРОФИТИНГИ

مرشحات الصغيرة و مواد الصغرى

Özellikler

- + Mikrofittings ile birlikte Ø7 mm Spagetti Borularda ve Ø16 mm, Ø20 mm, Ø25 mm ve Ø32 mm Alçak Yoğunluklu Polietilen (AYPE) Borularda (Düz Damla Sulama Borusu) kullanılır.
- + Minisprinklerin rotorları toz, böcek vb. girmesini önleyecek şekilde tasarlanmıştır.
- + Alan sulamalarında kullanılabilecek, maksimum verim sağlayan en ideal üründür.
- + Bitkinin büyümesi için gerekli suyun doğrudan bitki köklerine ulaşmasını sağlar.
- + Soğuk hava şartlarına karşı etkin koruma sağlar.

Specifications

- + Minisprinklers are used in Ø16 mm, Ø20 mm, Ø25 mm and Ø32 mm Low Density Polyethylene Pipes (LDPE) (Flat Drip Irrigation Pipe) and Ø7 mm Spaghetti Tube together with Microfittings.
- + Rotors of Minisprinklers are designed to prevent the entry of dust and insects, etc.
- + It is the **most ideal product** to be used in irrigation, and provides maximum efficiency.
- + Rotating Minisprinklers provide necessary irrigation directly to the roots of a plant.
- + It provides effective protection against cold weather conditions.

GARANTİ VERİLEN BASINÇ DEĞERİ : PN 2
GUARANTEED PRESSURE VALUE : PN 2

KULLANIM ALANLARI

- + Peyzaj Sektörü
- + Çiçek ve Sebze Bahçeleri
- + Fidanlıklar
- + Meyve Ağaçları
- + Seralar
- + Bahçe Sulamaları

INSTALLATION AREAS

- + Landscaping Systems
- + Flower and Vegetable Gardens
- + Plantations
- + Fruit Trees
- + Greenhouses
- + Garden Irrigations



MINİSPRİNKLER / MINISPRINKLERS

مرشات الصغيرة / МИНИСПРИНКЛЕРЫ

KOD CODE	NOZUL RENGİ NOZZLE COLOR	BOŞALTIM DEĞERİ PRECIPITATION (Lt/h)	SULAMA ÇAPİ IRRIGATION DIAMETER (m)		AMBALAJ ADEDİ PACKING QUANTITY	KOLİ ADEDİ BOX QUANTITY
			Tırnaklı With The Deflector	Tırnaksız Without The Deflector		
22080	■ AÇIK YEŞİL	80	6.0	1.0	25	2000
22100	■ AÇIK MAVİ	100	6.0	1.0	25	2000
22120	■ KIRMIZI	120	6.5	1.0	25	2000
22140	■ PEMBE	140	7.0	1.0	25	2000
22160	■ KAHVERENGİ	160	7.0	1.0	25	2000
22180	■ TURUNCU	180	7.5	1.0	25	2000
22200	■ SARI	200	7.5	1.0	25	2000
22265	□ BEYAZ	265	7.5	1.0	25	2000
22320	■ YEŞİL	320	8.0	1.0	25	2000
22360	■ MOR	360	8.0	1.0	25	2000
22400	■ MAVİ	400	8.0	1.0	25	2000



MINİSPRİNKLER UZUN MESAFE

MINISPRINKLERS LONG DISTANCE
МИНИСПРИНКЛЕРЫ С БОЛЬШОЙ
ЗОНОЙ ОРОШЕНИЯ
مرشات مسافات طويلة

KOD CODE	NOZUL RENGİ NOZZLE COLOR	BOŞALTIM DEĞERİ PRECIPITATION (Lt/h)	SULAMA ÇAPİ IRRIGATION DIAMETER (m)		AMBALAJ ADEDİ PACKING QUANTITY	KOLİ ADEDİ BOX QUANTITY
			Tırnaklı With The Deflector	Tırnaksız Without The Deflector		
23075	■ SİYAH	75	5.5	1.0	25	2000
23080	■ AÇIK YEŞİL	80	6.0	1.0	25	2000
23100	■ AÇIK MAVİ	100	6.0	1.0	25	2000
23120	■ KIRMIZI	120	7.0	1.0	25	2000
23140	■ PEMBE	140	7.0	1.0	25	2000
23160	■ KAHVERENGİ	160	7.0	1.0	25	2000
23180	■ TURUNCU	180	8.0	1.0	25	2000
23200	■ SARI	200	8.0	1.0	25	2000



MINİSPRİNKLER TIRNAKLI UZUN MESAFE

MINISPRINKLERS
LONG DISTANCE WITH DEFLECTOR
МИНИСПРИНКЛЕРЫ С БОЛЬШИМ
РАДИУСОМ ОРОШЕНИЯ, С ДЕФЛЕКТОРОМ
مرشات مسافات طويلة مع انحراف

KOD CODE	NOZUL RENGİ NOZZLE COLOR	BOŞALTIM DEĞERİ PRECIPITATION (Lt/h)	SULAMA ÇAPİ IRRIGATION DIAMETER (m)		AMBALAJ ADEDİ PACKING QUANTITY	KOLİ ADEDİ BOX QUANTITY
			Tırnaklı With The Deflector	Tırnaksız Without The Deflector		
24060	■ GRİ	60	3.5	1.0	25	2000
24075	■ SİYAH	75	3.5	1.0	25	2000
24080	■ AÇIK YEŞİL	80	3.5	1.0	25	2000
24100	■ AÇIK MAVİ	100	4.0	1.0	25	2000
24120	■ KIRMIZI	120	4.0	1.0	25	2000
24140	■ PEMBE	140	4.0	1.0	25	2000
24160	■ KAHVERENGİ	160	4.0	1.0	25	2000
24400	■ MAVİ	400	4.0	1.0	25	2000



MINİSPRİNKLER TIRNAKLI KISA MESAFE

MINISPRINKLERS
SHORT DISTANCE WITH DEFLECTOR
МИНИСПРИНКЛЕРЫ С МАЛЫМ
РАДИУСОМ ОРОШЕНИЯ, С ДЕФЛЕКТОРОМ
مرشات مسافات قصيرة مع انحراف

Minisprinklerin Sulama Çapı değerleri, Poelsan Minisprink Montajlı Takımı kullanılarak 20 cm yükseklikte ve 2 bar basınçta ölçülen değerlerdir.

Irrigation diameter values of Minisprinklers, by using Poelsan Minisprinkler Set is values measured PN 2 pressure and 20 cm height.

MINİSPRİNKLER / MINİSPRINKLERS

مرشات الصغيرة / МИНИСПРИНКЛЕРЫ



MINİSPRİNKLER MONTAJLI TAKIM UZUN MESAFE
MINİSPRİNKLER SET LONG DISTANCE
МИНИСПРИНКЛЕР С БОЛЬШИМ РАДИУСОМ ОРОШЕНИЯ. КОМПЛЕКТ В СБОРЕ
مرشات مسافات طويلة طاقم كامل

KOD CODE	NOZUL RENGİ NOZZLE COLOR	BOŞALTIM DEĞERİ PRECIPITATION (Lt/h)	SULAMA ÇAPI IRRIGATION DIAMETER (m)		AMBALAJ ADEDİ PACKING QUANTITY	KOLİ ADEDİ BOX QUANTITY
			Tırnaksız Without The Deflector	Tırnaklı With The Deflector		
25080	■ AÇIK YEŞİL	80	6.0		25	175
25100	■ AÇIK MAVİ	100	6.0		25	175
25120	■ KIRMIZI	120	6.5		25	175
25140	■ PEMBE	140	7.0		25	175
25160	■ KAHVERENGİ	160	7.0		25	175
25180	■ TURUNCU	180	7.5		25	175
25200	■ SARI	200	7.5		25	175
25265	□ BEYAZ	265	7.5		25	175
25320	■ YEŞİL	320	8.0		25	175
25360	■ MOR	360	8.0		25	175
25400	■ MAVİ	400	8.0		25	175



MINİSPRİNKLER MONTAJLI TAKIM TIRNAKLI UZUN MESAFE
MINİSPRİNKLER SET LONG DISTANCE WITH DEFLECTOR
МИНИСПРИНКЛЕР С БОЛЬШИМ РАДИУСОМ ОРОШЕНИЯ С ДЕФЛЕКТОРОМ. КОМПЛЕКТ В СБОРЕ
مرشات مسافات طويلة طاقم كامل مع انحراف

KOD CODE	NOZUL RENGİ NOZZLE COLOR	BOŞALTIM DEĞERİ PRECIPITATION (Lt/h)	SULAMA ÇAPI IRRIGATION DIAMETER (m)		AMBALAJ ADEDİ PACKING QUANTITY	KOLİ ADEDİ BOX QUANTITY
			Tırnaksız Without The Deflector	Tırnaklı With The Deflector		
26075	■ SİYAH	75	5.5	1.0	25	175
26080	■ AÇIK YEŞİL	80	6.0	1.0	25	175
26100	■ AÇIK MAVİ	100	6.0	1.0	25	175
26120	■ KIRMIZI	120	7.0	1.0	25	175
26140	■ PEMBE	140	7.0	1.0	25	175
26160	■ KAHVERENGİ	160	7.0	1.0	25	175
26180	■ TURUNCU	180	8.0	1.0	25	175
26200	■ SARI	200	8.0	1.0	25	175



MINİSPRİNKLER MONTAJLI TAKIM TIRNAKLI KISA MESAFE
MINİSPRİNKLER SET SHORT DISTANCE WITH DEFLECTOR
МИНИСПРИНКЛЕР С БОЛЬШИМ РАДИУСОМ ОРОШЕНИЯ С ДЕФЛЕКТОРОМ. КОМПЛЕКТ В СБОРЕ
مرشات مسافات قصيرة طاقم كامل مع انحراف

KOD CODE	NOZUL RENGİ NOZZLE COLOR	BOŞALTIM DEĞERİ PRECIPITATION (Lt/h)	SULAMA ÇAPI IRRIGATION DIAMETER (m)		AMBALAJ ADEDİ PACKING QUANTITY	KOLİ ADEDİ BOX QUANTITY
			Tırnaksız Without The Deflector	Tırnaklı With The Deflector		
27060	■ GRİ	60	3.5	1.0	25	175
27075	■ SİYAH	75	3.5	1.0	25	175
27080	■ AÇIK YEŞİL	80	3.5	1.0	25	175
27100	■ AÇIK MAVİ	100	4.0	1.0	25	175
27120	■ KIRMIZI	120	4.0	1.0	25	175
27140	■ PEMBE	140	4.0	1.0	25	175
27160	■ KAHVERENGİ	160	4.0	1.0	25	175
27400	■ MAVİ	400	4.0	1.0	25	175

Minisprink, Spagetti Boru (90 cm), Kurtağzı Erkek Nipel (1 adet) Kurtağzı Dişi Nipel (2 adet), Kazık (1adet)

Minisprinkler, Spaghetti Tube (90 cm), Barbed Male Nipple (1 piece) Barbed Female Nipple (2 pieces), Spike (1 piece)

KOD CODE	EBAT / SIZE d x g	AMBALAJ ADEDİ PACKING QUANTITY	KOLİ ADEDİ BOX QUANTITY
31076	Ø7 x Ø6	1000	36000

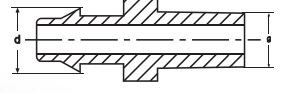

KURTAĞZI ERKEK NİPEL

BARBED MALE NIPPLE
НИППЕЛЬ РЕБРИСТЫЙ – «ШТУЦЕР»
زبانة شائكة سن خارج

KOD CODE	EBAT / SIZE d x g	AMBALAJ ADEDİ PACKING QUANTITY	KOLİ ADEDİ BOX QUANTITY
32076	Ø7 x Ø6	1000	32000

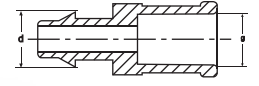

KURTAĞZI DIŞI NİPEL

BARBED FEMALE NIPPLE
НИППЕЛЬ РЕБРИСТЫЙ – «МУФТА»
زبانة شائكة سن داخل

KOD CODE	EBAT / SIZE d x d	AMBALAJ ADEDİ PACKING QUANTITY	KOLİ ADEDİ BOX QUANTITY
33077	Ø7 x Ø7	1000	36000

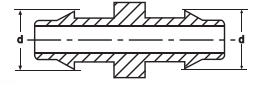

KURTAĞZI NİPEL

BARBED NIPPLE
НИППЕЛЬ РЕБРИСТЫЙ
زبانة شائكة

KOD CODE	EBAT / SIZE d	AMBALAJ ADEDİ PACKING QUANTITY	KOLİ ADEDİ BOX QUANTITY
34070	Ø7	1000	100000

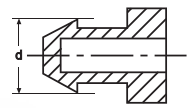

KURTAĞZI KÖR TAPA

BARBED END CAP
ЗАГЛУШКА РЕБРИСТАЯ
سدادة شائكة

MİKROFİTTİNGLER / MICROFITTINGS

مواد الصغرى / میکروفیتینگی

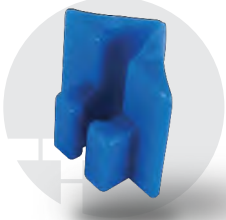

GÖVDE KORUYUCU
SEPARATOR
КОЛПАЧЕК-СЕПАРАТОР
منعزلة

KOD CODE	EBAT SIZE-mm	AMBALAJ ADEDİ PACKING QUANTITY	KOLİ ADEDİ BOX QUANTITY
30000	-	1000	30000



MİNİSPİNK KAZIĞI
MINISPRINK SPIKE
Стойка для миниспринклера
مرشات صغيرة

KOD CODE	EBAT SIZE-mm	AMBALAJ ADEDİ PACKING QUANTITY	KOLİ ADEDİ BOX QUANTITY
30350	350	25	400



KAZIK BAŞLIĞI
ROD ADAPTOR
АДАПТОР СТОЙКИ
محول قضيب

KOD CODE	EBAT SIZE-mm	AMBALAJ ADEDİ PACKING QUANTITY	KOLİ ADEDİ BOX QUANTITY
30607	6 x 7	100	2000
30611	6 x 11	100	2000



KAZIK BAŞLIĞI
ROD ADAPTOR
АДАПТОР СТОЙКИ
محول قضيب

KOD CODE	EBAT SIZE-mm	AMBALAJ ADEDİ PACKING QUANTITY	KOLİ ADEDİ BOX QUANTITY
30807	8 x 7	100	1800
30811	8 x 11	100	2000



SPAGETTİ BORU
SPAGHETTI TUBE
МИКРОТРУБКА
صوندة شريطية

KOD CODE	DIŞ ÇAP EXTERNAL DIAMETER (mm)	İÇ ÇAP INNER DIAMETER (mm)	ET KALINLIĞI WALL THICKNESS (mm)	AMBALAJ M/RULO PACKING m/coil
21707	7	4.5	1.25	100

MINİSPRİNKLER MONTAJ YÖNTEMİ

MINISPRINKLERS INSTALLATION METHOD

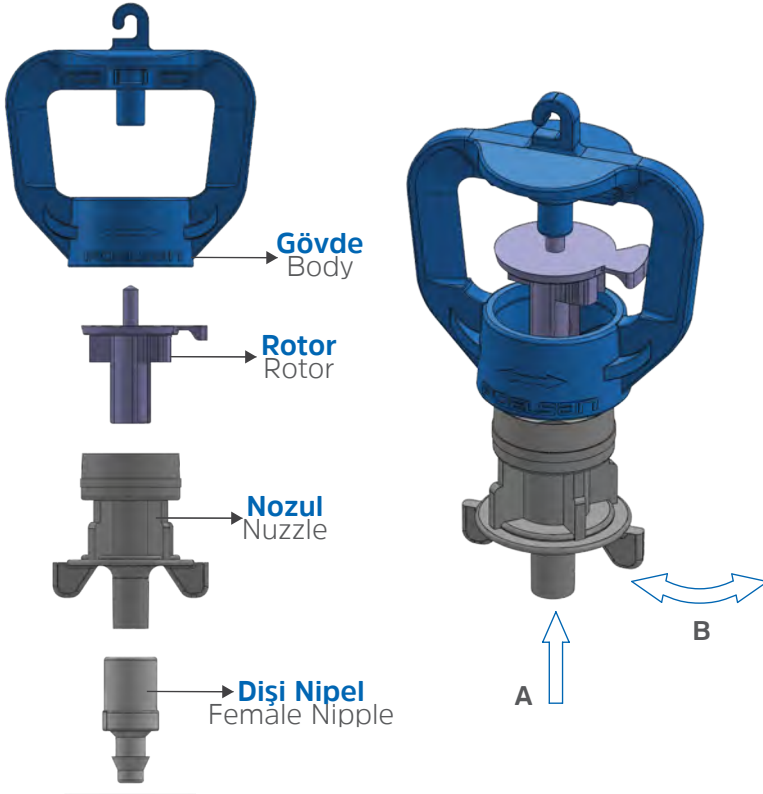

- + Gövde federleri, nozul federleri ile paralel olacak şekilde A yönünde montajı yapılmalıdır.
- + B yönünde gövde federleri ve nozul federleri 90° olacak şekilde çevrilerek demontajı yapılmalıdır.
- + It is assembled in the direction of A with the body tie pieces, and nozzle tie pieces parallel.
- + It is disassembled by turning the body tie pieces, and nozzle tie pieces 90 degrees in the direction of B.

MINİSPRİNKLER & MİKROFİTTİNGLER

MINISPRINKLERS & MICROFITTINGS

МИНИСПРИНКЛЕРЫ И МИКРОФИТИНГИ

مرشحات الصغيرة و مواد الصغرى

DİKKAT EDİLMESİ GEREKEN HUSUSLAR

- + Ø7 mm Kurtağzı ucu Alçak Yoğunluklu Polietilen (AYPE) boruya takmak için boru Ø3 mm delinmelidir.
- + Henüz fidan halinde olan bitkiler için tırnaklı rotor tipi Minisprinklerin kullanılması daha verimli olacaktır. Büyüyen fidanlarda ise geniş alan sulaması gerektirdiği için rotor üzerinde bulunan tırnak kesilerek kullanılır.

POINTS TO TAKE INTO CONSIDERATION

- + For the installation of the Ø7 mm barbed end to the Low Density Polyethylene Pipe (LDPE), the pipe should be punched Ø3 mm.
- + Using Rotating Minisprinklers with the deflector on the rotor will be more efficient for young plants. Bigger plants need a wide scaled irrigation, therefore Minisprinklers are used by fracturing the deflectors on the rotor.

HAT ÜSTÜ DAMLATICILAR

ON - LINE DRIPPERS

КАПЕЛЬНИЦА С РЕГУЛИРОВКОЙ РАСХОДА
قطرة

Özellikler

- + Kullanım alanlarında **montaj kolaylığı sağlar.**
- + Ø16 mm, Ø20 mm, Ø25 mm ve Ø32 mm **Alçak Yoğunluklu Polietilen (AYPE) Borularda (Düz Damla Sulama Boruları) kullanılır.**
- + **Mikrofittingler** ile birlikte Ø7 mm **Spagetti borularda** kullanılır.
- + **Damlaticının kapağı kolay sökülüp takılabilir** şekilde olması damlaticının temizlenmesi işlemini kolaylaştırır.

Specifications

- + On - Line Drippers provide **easy installation.**
- + On - Line Drippers are used in Ø16 mm, Ø20 mm, Ø25 mm and Ø32 mm **Low Density Polyethylene Pipe (LDPE) (Flat Drip Irrigation Pipe).**
- + **On - Line Drippers** are used in Ø7 mm **Spaghetti Tube** together with Microfittings.
- + **The simple demountable cover of dripper** facilitates the cleaning process.



KULLANIM ALANLARI

- + Peyzaj Sektörü
- + Çiçek ve Sebze Bahçeleri
- + Fidanlıklar
- + Meyve Ağaçları
- + Seralar
- + Bahçe Sulamaları
- + Saksı Sulamaları

INSTALLATION AREAS

- + Landscaping Systems
- + Flower and Vegetables Gardens
- + Plantations
- + Fruit Trees
- + Greenhouses
- + Garden Irrigations
- + Pot Irrigations

HAT ÜSTÜ DAMLATICILAR / ON - LINE DRIPPERS

KOD CODE	TİP TYPE (lt/h)	AMBALAJ ADEDİ PACKING QUANTITY	KOLİ ADEDİ BOX QUANTITY	ÇUVAL ADEDİ SACK QUANTITY
40070	0-70	100	8000	10000

KLİK CLICK	BOŞALTIM DEĞERİ DISCHARGE (lt/h)					
	0.5 bar	1.0 bar	1.5 bar	2.0 bar	2.5 bar	3.0 bar
2	4.0	9.8	12.2	15.2	17.3	20.2
8	9.9	15.7	22.8	26.4	27.9	33.0
12	18.7	30.0	38.9	45.1	49.7	57.0
16 (1 Tam tur) (Full round)	25.4	38.9	53.1	60.4	68.1	75.7
20	29.6	45.0	61.8	69.7	78.9	88.4
24	33.9	52.4	71.2	78.0	90.5	101.0

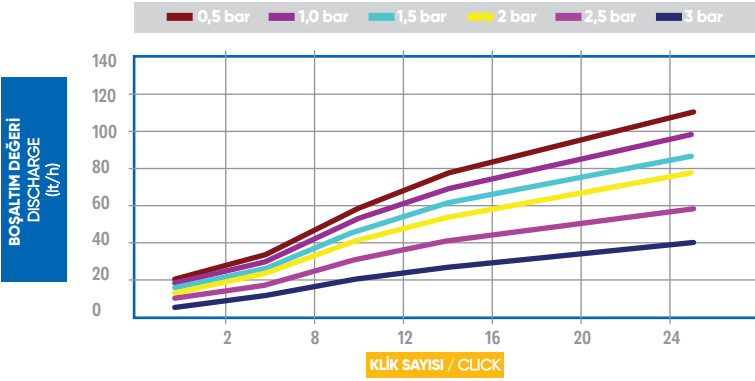

KOD CODE	TİP TYPE (lt/h)	AMBALAJ ADEDİ PACKING QUANTITY	KOLİ ADEDİ BOX QUANTITY	ÇUVAL ADEDİ SACK QUANTITY
40100	0-100	100	4000	4000

KLİK CLICK	BOŞALTIM DEĞERİ DISCHARGE (lt/h)					
	0.5 bar	1.0 bar	1.5 bar	2.0 bar	2.5 bar	3.0 bar
2	0.3	0.4	0.5	0.6	0.8	1.0
8	9.6	15.2	19.0	21.8	25.4	30.1
12	13.7	22.3	28.3	33.6	37.9	42.6
16 (1 Tam tur) (Full round)	31.0	48.2	62.5	72.3	79.6	84.7
20	56.2	84.9	110.9	125.7	137.7	146.0
24	81.7	116.5	147.6	172.5	187.8	206.3
28	84.8	122.9	153.4	179.0	202.4	216.4
32	86.0	125.3	154.1	179.4	202.9	217.3

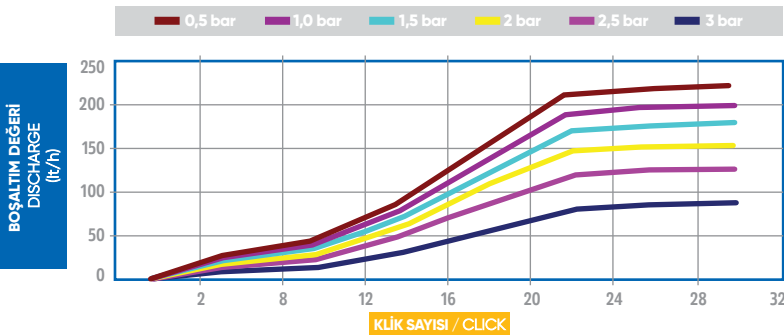

DEBİ AYARLI HAT ÜSTÜ DAMLATICI
ON - LINE DRIPPERS
КАПЕЛЬНИЦА С РЕГУЛИРОВКОЙ РАСХОДА
قطرة

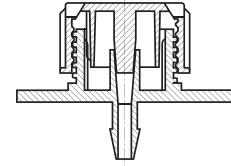

КАПЕЛЬНИЦА С РЕГУЛИРОВКОЙ РАСХОДА / قطرة



DEBİ AYARLI HAT ÜSTÜ DAMLATICI
ON - LINE DRIPPERS
КАПЕЛЬНИЦА С РЕГУЛИРОВКОЙ РАСХОДА
قطرة

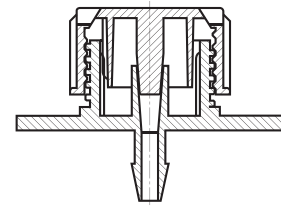

HAT ÜSTÜ DAMLATICILAR

ON - LINE DRIPPERS

КАПЕЛЬНИЦА С РЕГУЛИРОВКОЙ РАСХОДА

قطرة

DİKKAT EDİLMESİ GEREKEN HUSUSLAR

- + Hat Üstü Damlatıcı, boru üzerine delme aparatı ile çapı 3 mm olacak şekilde delik delinerek kolayca takılır.
- + Sistemde kullanılacak filtrenin minimum süzme kapasitesi 125 mikron olmalıdır.

POINTS TO TAKE INTO CONSIDERATION

- + On - Line Drippers are easily inserted by punching a 3 mm hole on the pipe.
- + The minimum filtration capacity of the filter used in the system shall be 125 microns.



ÖZEL ÜRETİMLERİMİZ

SPECIAL PRODUCTIONS
СПЕЦИАЛЬНОЕ ПРОИЗВОДСТВО
منتجات خاصة

RURAL EK PARÇALAR

RURAL FITTINGS
ФИТИНГИ ПОЛЕВЫЕ
مواد فلاحية



RURAL KÜRESEL VANA

RURAL BALL VALVES
КРАНЫ ПОЛЕВЫЕ
الاقفالة فلاحية



ÖZEL ÜRETİM
(SPECIAL PRODUCTION)
RURAL EK PARÇALAR
RURAL FITTINGS
ФИТИНГИ ПОЛЕВЫЕ
معدات فلاحية

Özellikler

- + Darbelere karşı dayanıklı, yüksek kaliteli polipropilen hammaddeden üretilmiştir.
- + UV ışınlarını geçirmediği için yosunlanmaya ve bakteri üremesine izin vermez.
- + Oringi kauçuktan üretilmekte olup yüksek basınç altında sızdırmazlık sağlar.
- + İç yüzeyleri homojen ve gözeneksizdir.
- + Suyun kokusunu ve tadını değiştirebilecek zararlı bileşikler içermez.

Specifications

- + It has been produced from high quality polypropylene raw material and it has resistance to impact.
- + They prevent alga and bacteria forming due to UV proof (ultraviolet beam) structure.
- + O-rings are made of rubber and provide leakproofness under high pressure.
- + It has a homogeneous and non-porous inner surface.
- + It does not contain any harmful compounds which can change the taste or the smell of the water.

GARANTİ VERİLEN BASINÇ DEĞERİ : PN 10
GUARANTEED PRESSURE VALUE : PN 10

KULLANIM ALANLARI

- + Tarımsal Sulama
- + Seralar

INSTALLATION AREAS

- + Agricultural Irrigation
- + Greenhouses



RURAL EK PARÇALAR / RURAL FITTINGS

قطع وصل رورال / ФИТИНГИ ПОЛЕВЫЕ/

KOD CODE	EBAT / SIZE d x G	AMBALAJ ADEDİ PACKING QUANTITY	KOLİ ADEDİ BOX QUANTITY
20011	20 (3/4") x 1/2"	50	500
20012	20 (3/4") x 3/4"	50	500
20021	25 (1") x 1/2"	25	350
20022	25 (1") x 3/4"	25	350
20023	25 (1") x 1"	25	350
20031	32 (1 1/4") x 1/2"	25	225
20032	32 (1 1/4") x 3/4"	25	200
20033	32 (1 1/4") x 1"	25	200
20034	32 (1 1/4") x 1 1/4"	25	200
20043	40 (1 1/2") x 1"	15	120
20044	40 (1 1/2") x 1 1/4"	15	120
20045	40 (1 1/2") x 1 1/2"	15	120
20054	50 (2") x 1 1/4"	10	80
20055	50 (2") x 1 1/2"	10	70
20056	50 (2") x 2"	10	80



ERKEK ADAPTÖR

MALE ADAPTOR

محوالة سن خارج

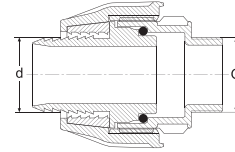

KOD CODE	EBAT / SIZE d x G	AMBALAJ ADEDİ PACKING QUANTITY	KOLİ ADEDİ BOX QUANTITY
20111	20 (3/4") x 1/2"	50	500
20112	20 (3/4") x 3/4"	50	500
20121	25 (1") x 1/2"	25	350
20122	25 (1") x 3/4"	25	350
20123	25 (1") x 1"	25	300
20132	32 (1 1/4") x 3/4"	25	225
20133	32 (1 1/4") x 1"	25	225
20134	32 (1 1/4") x 1 1/4"	25	150
20143	40 (1 1/2") x 1"	15	90
20144	40 (1 1/2") x 1 1/4"	15	90
20145	40 (1 1/2") x 1 1/2"	15	105
20154	50 (2") x 1 1/4"	10	80
20155	50 (2") x 1 1/2"	10	80
20156	50 (2") x 2"	10	70



DIŞİ ADAPTÖR

FEMALE ADAPTOR

محوالة سن داخل

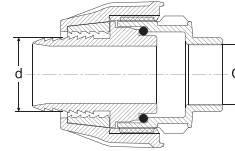

KOD CODE	EBAT / SIZE d x d	AMBALAJ ADEDİ PACKING QUANTITY	KOLİ ADEDİ BOX QUANTITY
20211	20 (3/4") x 20 (3/4")	25	300
20222	25 (1") x 25 (1")	25	200
20233	32 (1 1/4") x 32 (1 1/4")	10	120
20244	40 (1 1/2") x 40 (1 1/2")	10	60
20255	50 (2") x 50 (2")	6	36



MANŞON

COUPLING

رباطة

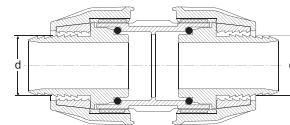

RURAL EK PARÇALAR / RURAL FITTINGS

قطع وصل رورال / ФИТИНГИ ПОЛЕВЫЕ



REDÜKSIYON TE
REDUCING TEE
تقسيم مصغري

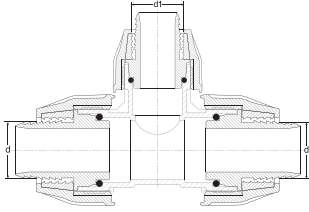

KOD CODE	EBAT / SIZE d x d ₁ x d ₂	AMBALAJ ADEDİ PACKING QUANTITY	KOLİ ADEDİ BOX QUANTITY
21312	20 (¾") x 25 (1") x 20 (¾")	10	160
21321	25 (1") x 20 (¾") x 25 (1")	10	140
21323	25 (1") x 32 (1 ¼") x 25 (1")	10	90
21331	32 (1 ¼") x 20 (¾") x 32 (1 ¼")	5	90
21332	32 (1 ¼") x 25 (1") x 32 (1 ¼")	5	80
21342	40 (1 ½") x 25 (1") x 40 (1 ½")	5	55
21343	40 (1 ½") x 32 (1 ¼") x 40 (1 ½")	5	45
21352	50 (2") x 25 (1") x 50 (2")	4	28
21353	50 (2") x 32 (1 ¼") x 50 (2")	4	28
21354	50 (2") x 40 (1 ½") x 50 (2")	4	28



REDÜKSIYON MANŞON
REDUCING COUPLING
مصغرة

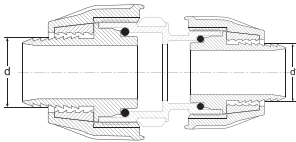

KOD CODE	EBAT / SIZE d x d ₁	AMBALAJ ADEDİ PACKING QUANTITY	KOLİ ADEDİ BOX QUANTITY
21421	25 (1") x 20 (¾")	25	250
21431	32 (1 ¼") x 20 (¾")	10	180
21432	32 (1 ¼") x 25 (1")	10	150
21441	40 (1 ½") x 20 (¾")	10	110
21442	40 (1 ½") x 25 (1")	10	100
21443	40 (1 ½") x 32 (1 ¼")	10	90
21452	50 (2") x 25 (1")	6	72
21453	50 (2") x 32 (1 ¼")	6	60
21454	50 (2") x 40 (1 ½")	6	54

KOD CODE	EBAT / SIZE d x d ₁	AMBALAJ ADEDİ PACKING QUANTITY	KOLİ ADEDİ BOX QUANTITY
21621	25 (1") x 20 (¾")	15	210
21632	32 (1 ¼") x 25 (1")	10	140
21643	40 (1 ½") x 32 (1 ¼")	5	80
21654	50 (2") x 40 (1 ½")	4	48



REDÜKSİYON DİRSEK
REDUCING ELBOW
عكس مصغرة

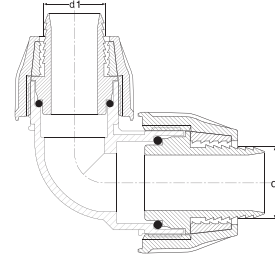

KOD CODE	EBAT / SIZE d	AMBALAJ ADEDİ PACKING QUANTITY	KOLİ ADEDİ BOX QUANTITY
21511	20 (¾")	50	650
21522	25 (1")	25	400
21533	32 (1 ¼")	25	225
21544	40 (1 ½")	15	150
21555	50 (2")	12	84



KÖR TAPA
END CAP
سدادة

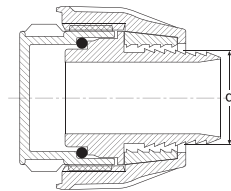

ÖZEL ÜRETİM
(SPECIAL PRODUCTION)
RURAL EK PARÇALAR
RURAL FITTINGS
ФИТИНГИ ПОЛЕВЫЕ
معدات فلاحية

**DİKKAT EDİLMESİ GEREKEN
HUSUSLAR**

- +Rural borular, ingiliz birim sistemine (inç) göre üretilmiştir. Ölçü farklılığı sebebiyle Rural Ek Parçaların metrik sisteme (mm) göre üretilen borularda kullanımı uygun değildir.
- +İç tutucu gövde içerisine montajlanırken oringin yerinde olmasına dikkat edilmelidir.
- +Boru uçları düz kesilmelidir.

**POINTS TO TAKE INTO
CONSIDERATION**

- +Rural pipes are produced with British unit of measure (inch), it is not appropriate to use Rural Fittings with the pipes produced with metric system, because of measure difference.
- +While assembling the inner holder inside the body, it should be paid attention that the o-ring is in the right place.
- +Pipe ends should be cut straightly.

ÖZEL ÜRETİM
(SPECIAL PRODUCTION)
RURAL KÜRESEL VANA
RURAL BALL VALVES
КРАНЫ ПОЛЕВЫЕ
اقفال فلاحية

Özellikler

- + Darbelere karşı dayanıklı, yüksek kaliteli polipropilen hammaddeden üretilmiştir.
- + Vananın her iki yönünden de akış sağlamak mümkündür.
- + Akışkan geçişinde basınç ve debi kaybına sebep olmaz.
- + Sisteminizde kolay montaj imkânı sağlar.
- + Oring kauçuktan üretilmekte olup yüksek basınç altında sızdırmazlık sağlar.
- + Suyun kokusunu ve tadını değiştirebilecek zararlı bileşikler içermez.

Specifications

- + It has been produced from high quality polypropylene raw material and it has resistance to impact.
- + It is possible to provide bidirectional flow in the valve.
- + They do not cause any pressure or flow loss during fluid pass.
- + They supply easy installation in your system.
- + O-rings are made of rubber and provide leakproofness under high pressure.
- + It does not contain any harmful compounds which can change the taste or the smell of the water.

GARANTİ VERİLEN BASINÇ DEĞERİ : PN 10
GUARANTEED PRESSURE VALUE : PN 10

KULLANIM ALANLARI

- + Peyzaj Sektörü
- + Tarımsal Sulama

INSTALLATION AREAS

- + Landscaping Systems
- + Agricultural Irrigation



RURAL KÜRESEL VANA / RURAL BALL VALVES

صمام كروي رورال / КРАНЫ ПОЛЕВЫЕ



RURAL KÜRESEL VANA ERKEK - KABLİN

RURAL BALL VALVE MALE - COUPLING

منتجات خاصة و اقفال فلاحية

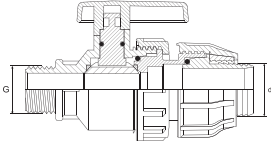

KOD CODE	EBAT / SIZE G x d	AMBALAJ ADEDİ PACKING QUANTITY	KOLİ ADEDİ BOX QUANTITY
99634	1" x 40 (1 1/2")	4	48
99644	1 1/4" x 40 (1 1/2")	4	48
99645	1 1/4" x 50 (2")	2	28
99655	1 1/2" x 50 (2")	2	26



RURAL KÜRESEL VANA KABLİN - DIŞI

RURAL BALL VALVE COUPLING - FEMALE

اقفال فلاحية سن داخل- رباطة

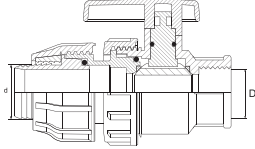

KOD CODE	EBAT / SIZE d x D	AMBALAJ ADEDİ PACKING QUANTITY	KOLİ ADEDİ BOX QUANTITY
99732	32 (1 1/4") x 3/4"	4	100
99733	32 (1 1/4") x 1"	4	96
99743	40 (1 1/2") x 1"	4	48
99744	40 (1 1/2") x 1 1/4"	4	48
99754	50 (2") x 1 1/4"	2	32
99755	50 (2") x 1 1/2"	2	32



RURAL KÜRESEL VANA KABLİN - KABLİN

RURAL BALL VALVE COUPLING - COUPLING

اقفال فلاحية سن رباطة- رباطة

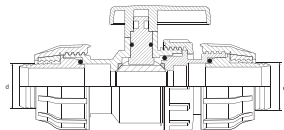

KOD CODE	EBAT / SIZE d x d	AMBALAJ ADEDİ PACKING QUANTITY	KOLİ ADEDİ BOX QUANTITY
99844	40 (1 1/2") x 40 (1 1/2")	4	36
99855	50 (2") x 50 (2")	2	24

ÖZEL ÜRETİM
(SPECIAL PRODUCTION)
RURAL KÜRESEL VANA
RURAL BALL VALVES
КРАНЫ ПОЛЕВЫЕ
اقفال فلاحية

**DİKKAT EDİLMESİ GEREKEN
HUSUSLAR**

- + Kullanılacak sistemde Filtre kullanılmalıdır.
- + Filtre kullanılmayan durumlarda vana içerisindeki parçalar zarar görebilir, çalışma ömrü kısalmır.
- + Vanalar sökülüp takılabilen parçalardan meydana gelmektedir. Sökülen parçaların tekrar yerine doğru montajı yapılmalıdır.
- + Dişli kısımların montajında teflon vb. sızdırmazlık elemanı kullanılmalıdır.
- + Küresel vanalar su dışındaki akışkanlar için kullanıma uygun değildir.
- + Rural borular, İngiliz birim sistemine (inç) göre üretilmiştir. Ölçü farklılığı sebebiyle Rural Ek Parçaların metrik sisteme (mm) göre üretilen borularda kullanımı uygun değildir.
- + İç tutucu gövde içerisine montajlanırken oringin yerinde olmasına dikkat edilmelidir.
- + Boru uçları düz kesilmelidir.

**POINTS TO TAKE INTO
CONSIDERATION**

- + The filter should be used in the system.
- + When the filter is not used, the parts inside the valve may be damaged, and the working life will be shortened.
- + Valves consist of parts that can be disassembled, and assembled. The dismantled parts must be assembled correctly.
- + Sealing elements such as Teflon etc. should be used in the assembly of the threaded parts.
- + Ball valves are not suitable for fluids other than water.
- + Rural pipes are produced according to the British unit system (inch). Rural Fittings are not suitable for the pipes produced according to the metric system (mm) due to the difference in size.
- + While assembling the inner holder inside the body, it should be paid attention that the o-ring is in the right place.
- + Pipe ends should be cut straightly.

SERTİFİKALARIMIZ / CERTIFICATES



MARKA TESCİL BELGESİ
BRAND REGISTRATION



KALİTE YÖNETİM BELGESİ
QUALITY MANAGEMENT
SYSTEM CERTIFICATE



ÇEVRE YÖNETİM BELGESİ
ENVIRONMENT MANAGEMENT
SYSTEM CERTIFICATE



İŞ SAĞLIĞI GÜVENLİĞİ
OCCUPATIONAL HEALTH &
SAFETY MANAGEMENT SYSTEM
CERTIFICATE



YENİ MAVİ SERİ
AMERİKA PATENTİ
NEW BLUE SERIES
USA DESIGN PATENT



KIWA BELGESİ
KIWA CERTIFICATE



TSE COVID-19
GÜVENLİ ÜRETİM BELGESİ
TSE COVID-19
SAFE PRODUCTION CERTIFICATE



MAVİ SERİ
TASARIM TESCİL BELGESİ
BLUE SERIES - DESIGN
REGISTRATION CERTIFICATE



YENİ MAVİ SERİ
TASARIM TESCİL
NEW BLUE SERIES - DESIGN
REGISTRATION CERTIFICATE



YENİ PRİZ KOLYE
TASARIM TESCİL
NEW CLAMP SADDLE
DESIGN REGISTRATION
CERTIFICATE



YENİ YEŞİL SERİ
TASARIM TESCİL
NEW GREEN SERIES - DESIGN
REGISTRATION CERTIFICATE

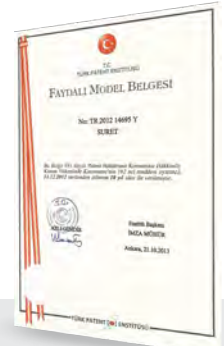

ESNEK BORU TUTUCULAR
FAYDALI MODEL BELGESİ
UTILITY MODEL CERTIFICATE
FLEXIBLE O-RING HOLDERS



TS ISO 17885 TÜRK
STANDARTLARINA UYGUNLUK
TSE ISO 17885 Certificate Of
Conformity to TSE



TS ISO 13460-1 TÜRK
STANDARTLARINA UYGUNLUK
TSE ISO 13460-1 Certificate
Of Conformity to TSE



TS ISO 9911 VANALAR TSE
KRİTERLERİNE UYGUNLUK
TS ISO 9911 Valves Certificate
Of Conformity to TSE



TS ISO 9261 TÜRK
STANDARTLARINA UYGUNLUK
TS ISO 9261 Certificate
Of Conformity to TSE



TS 13716 VANA KUTULARI TÜRK
STANDARTLARINA UYGUNLUK
TS 13716 Valve Boxes Certificate
Of Conformity to TSE

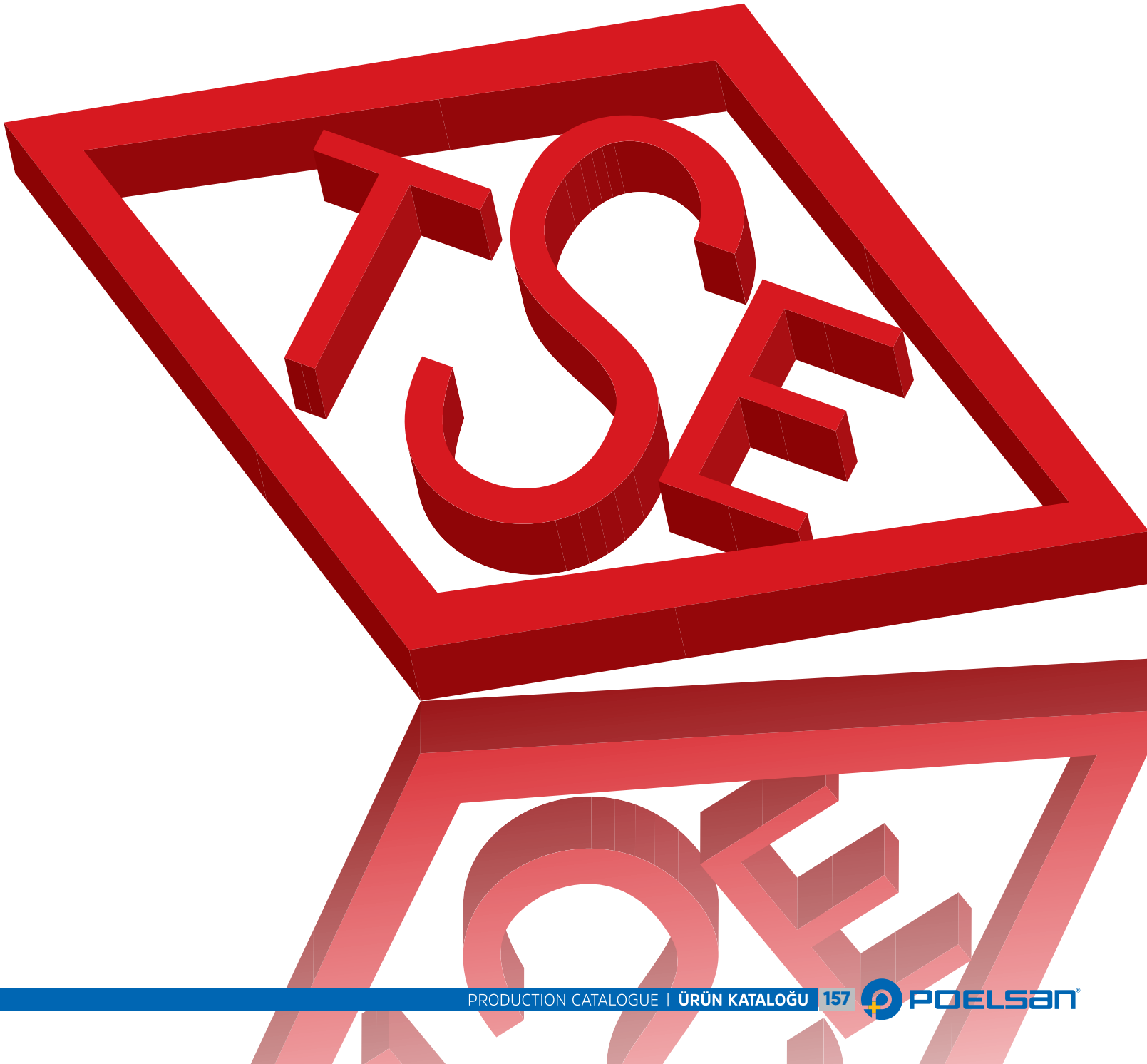

AMBALAJ BİLGİLERİMİZ / PACKAGE INFORMATION



Koli Kullanılan Ürün Grupları

Mavi Seri
Yeşil Seri
Priz Kolye Geçmeli
Layflat Ek Parçaları & Çıkış Nipelleri
Dişli Bağlantı Elemanları
Mini Vanalar (DN 8)
Mini Vanalar (DN 15)
Damla Sulama Kurtağzı Ek Parçaları
Yassı Damla Sulama Ek Parçaları
Yüzüklü Yassı Damla Sulama Ek Parçaları
Minisprinkler & Mikrofittingler
Hat Üstü Damlatıcılar
Priz Kolye
Manyetik Lokma Ucu
(16080, 16083)
Yeşil Seri Küresel Vana
Mavi Seri Küresel Vana
Boru Delme Aparatı
(16096, 16098, 16092, 16094)

Product Series in Box

Blue Series
Green Series
Clamp Saddles With Slide
Layflat Fittings & Offtake Nipples
Threaded Fittings
Mini Valves (DN 8)
Mini Valves (DN 15)
Dripline Barbed Fittings
Drip Tape Fittings
Drip Tape Fittings With Ring
Minisprinklers & Microfittings
On-Line Drippers
Clamp Saddles
Magnetic Socket Wrench
(16080, 16083)
Green Series Ball Valves
Blue Series Ball Valves
Driller
(16096, 16098, 16092, 16094)

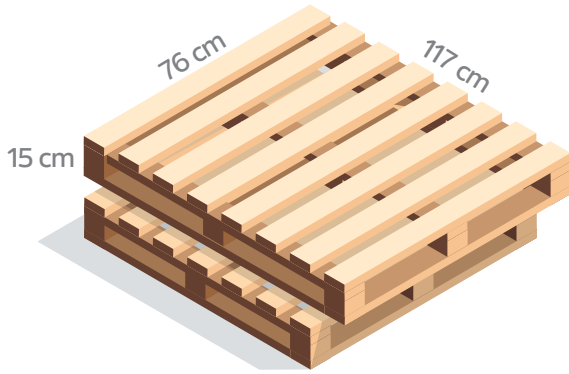

Palet Kullanılan Ürün Grupları

Vana Kutuları

Product Series in The Pallet

Valve Boxes



Çuval Kullanılan Ürün Grupları

+ Küresel Vanalar hariç tüm ürünlerimizde çuval kullanılmaktadır.

NOTLAR / NOTES

Blank area for notes, consisting of 20 horizontal grey lines.

NOTLAR / NOTES

Blank area for notes, consisting of multiple horizontal lines.

NOTLAR / NOTES

Blank area for notes, consisting of multiple horizontal lines.

NOTLAR / NOTES

Blank area for notes, consisting of 20 horizontal grey bars.

NOTLAR / NOTES

Blank area for notes, consisting of multiple horizontal lines.

NOTLAR / NOTES

Blank area for notes, consisting of 20 horizontal grey lines.

NOTLAR / NOTES

Blank area for notes, consisting of 20 horizontal grey lines.

NOTLAR / NOTES

Blank area for notes, consisting of multiple horizontal lines.



01/2021

Şabanoğlu OSB Mahallesi Ulubatlı Caddesi No: 6 Tekkeköy SAMSUN TÜRKİYE
Tel: +90 362 266 75 24 Faks: +90 362 266 77 51 GSM: +90 544 366 69 64

www.poelsan.com    poelsan   poelsanplastik poelsan@poelsan.com