

FİYAT KATALOĐU

ocak / 2020



*“Dünden bugüne her zaman daha iyisi,
her zaman daha yenisi...”*



 **IZELTAS**

www.izeltas.com.tr



izeltas_



izeltaselaletleri



@izeltrastr



Izeltas A.S.

GARANTİ ŞARTLARI / WARRANTY CONDITIONS



A-KAPSAM İÇİ

1. Normal kullanım şartlarına uygun kullanılan ancak, imalat veya malzeme hatası tespit edilen ürünler, ömür boyu garanti kapsamında, tamir edilir veya mümkün değilse, derhal yenisi ile değiştirilir.

B-KAPSAM DIŞI

Aşağıda yazılı şartlarda kullanılan aletler, garanti kapsamı dışında olup, yenisi ile değiştirilmezler.

1. Kullanım amacı veya kullanma talimatı dışında kullanılmış olan ürünler.
2. Aşırı zorlama ile, boru takılarak veya çekiçle vurularak darbeli kullanım sonucu deforme olmuş ya da kırılmış olan ürünler.
3. Kullanıcı tarafından üzerinde taşlama, zımparalama, delme veya kaynak yapılarak orijinal hali bozulmuş olan ürünler.
4. Kullanıldıktan sonra, gerekli koruyucu bakımları yapılmadan, tozlu, rutubetli ve çamurlu ortamlarda bekletilerek fonksiyonu kaybolmuş ürünler.
5. Uygun olmayan rutubetli ortamlarda, uzun süre stoklanarak, paslanmış, korozyona uğramış olanlar.
6. Uzun süre kullanılmış veya kullanım ömrünü tamamlamış, buna bağlı olarak eskimiş, yıpranmış, deforme olmuş ürünler.

EMNİYETLİ VE DOĞRU EL ALETİ KULLANIM KURALLARI

A-UYULMASI GEREKEN KURALLAR:

1. Anahtarın ölçüsünün kullandığınız parçaya göre uygun olduğundan emin olunuz.
2. Kullanım esnasında aletin doğru şekilde yerleştirildiğinden emin olunuz.
3. Aleti sık kontrol ediniz. Aşınmış, zarar görmüş aletleri değiştiriniz.
4. Aleti kullanım şartlarına uygun olarak kullanınız, aşırı yük uygulamayınız.
5. Özellikle çekiçlerde vurma yüzeyinin, vurulan yüzeyden daha büyük olmak zorunda olduğuna dikkat ediniz.
6. Havalı aletlerde daima uygun aksesuarı kullanınız. (Ayrıca basınçlı havanın yağlandığından emin olunuz.)
7. Çalışma şartlarına göre uygun kişisel koruma teçhizatı kullanınız.
8. Tekerlekli takım dolaplarını, daima kapılarını ve hareketli bölümlerini kilitledikten sonra hareket ettiriniz.
9. Tekerlekli takım dolabı üzerinde çalışırken, tekerleklerini frenleyiniz.
10. Yüksek gerilimli çalışma ortamlarında TS EN IEC 60900 Standartına uygun olarak üretilmiş VDE belgeli ürünleri kullanınız.
11. Aletlerin nemli ve ıslak ortamlarda kullanımını ardından mutlaka kurutunuz ve hafif yağlayınız.

B-YAPILMAMASI GEREKEN İŞLEMLER:

1. Boru vb. uzatmalar kullanılarak olması gereken tork gücünü aşmayınız. (Özellikle tüm anahtarlarda)
2. Hiçbir aleti üretim maksadına aykırı işlerde kullanmayınız. (örneğin: tornavidanın levye veya keski gibi kullanımı)
3. Aşırı güç uygulayarak (boru takarak veya çekiçle vurarak) aleti zorlamayınız. (örneğin: anahtarlar ve tornavidalar)
4. Hiçbir zaman, kullandığınız aleti kendinden daha sert olan bir cisme vurmayınız. (örneğin: çekiç ve keski)
5. Aletleri değişikliğe uğratmayınız. (Şeklini veya bir kısmını)
6. Metrik ölçülü anahtarları, inch ölçülü civatalarda kullanmayız veya tersini yapmayınız.
7. Yıpranmış ve hatalı aletleri kullanmayınız.
8. Tekerlekli tamir dolabı dolu iken, birden fazla çekmeceyi açık tutmayınız, çekmeceler açıkken hareket ettirmeyiniz.
9. Aletin fonksiyonunu iyileştirmek maksadı ile üzerinde zımpara, taş, kaynak vb. işlem yapmayınız.
10. Aletin kullanımı sırasında boya veya kaplamanın çıkacağı etkilere maruz bırakmayınız. Aksi halde korozyon dayanımı negatif etkilenecektir.
11. İzolasyonu zedelenmiş, sapı yıpranmış VDE sertifikalı ürünleri hiçbir şekilde yüksek gerilim ihtiva eden ortamlarda kullanmayınız.
12. Kontrol kaleminin iç mekanizmasını kesinlikle sökmeye çalışmayınız. Kontrol kalemleri 110 – 250 VAC çalışma aralığı için uygundur.
13. Yukarıda bahsedilen şartlara ve doğru kullanıma riayet ederek, her zaman amaca yönelik uygun aletleri kullanınız.

A- INCLUDED CASES

1. Products used in accord with normal use conditions but found to have production or material errors will be repaired or if this is not possible replaced immediately under lifetime warranty.

B- EXCLUDED CASES

Products used under any of the conditions listed below are excluded from the warranty scope and cannot be replaced with new ones:

1. Products used outside the intended purpose or instructions of use;
2. Products deformed or broken due to excessive forcing, pipe attachment or hammer impact;
3. Products whose original form is altered by the user by stoning, grinding, perforation or welding;
4. Products which lost their function due to being left in dusty, moist or muddy environments without necessary protective maintenance after use;
5. Products which became rusted or corroded due to being stored in unsuitable, moist environments for extended periods of time;
6. Products which are used for a long period of time or which have completed their useful life and accordingly have become old, worn out and deformed.

RULES FOR SAFE AND CORRECT USE OF HAND TOOL

A- PRACTICAL RULES:

1. Make sure size of the wrench is appropriate for the work piece.
2. Make sure the tool is positioned correctly during use.
3. Frequently control the tool. Replace worn or damaged tools.
4. Use the tool in accord with instructions of use. Do not place too much load on the tool.
5. Especially beware of the point that the impact surface of a hammer must be larger than the impacted surface.
6. Always use appropriate accessories for pneumatic tools. (Also make sure the pneumatic system is properly lubricated.)
7. Use personal protection equipment appropriate for work conditions.
8. Always make sure to lock lids and moving parts of wheeled set cabinets before moving them.
9. Make sure to lock brakes of the wheeled set cabinets before working on them.
10. Use VDE certified products made in accord with TS EN IEC 60900 Standard in high voltage work environments.
11. Make sure to dry and lightly lubricate tools after use in moist and wet environments.

B- ACTIONS TO AVOID:

1. In case of use with extensions like pipes, etc. do not exceed the specified torque value (especially in case of all wrenches).
2. Do not use any tool outside of its intended purpose (e.g. do not use a screwdriver as a lever or a chisel).
3. To not force the tool (e.g. wrenches and screwdrivers) by using excessive force (by pipe attachment or hammer impact).
4. Never use the tool to hit another object harder than the tool (e.g. hammer and chisels).
5. Do not alter the tools (in form or partially).
6. Do not use metric sized wrenches on inch sized bolts or vice-versa.
7. Do not use worn out or faulty tools.
8. Do not leave multiple drawers open when using the wheeled set cabinet and do not move the cabinet while the drawers are open.
9. Do not perform grinding, stoning, welding, etc. on the tool in order to improve its function.
10. Do not expose the tool to conditions that might result in loss of paint or coating during use. Otherwise corrosion resistance of the tool will be negatively affected.
11. Never use VDE certified products with damaged or worn isolation or handle in high voltage work environments.
12. Never attempt to dismantle the internal assembly of the tester. Testers are suitable for use in the 110 – 250 VAC operation range.
13. Always use the right tool for the right job and follow the conditions and rules of correct usage detailed above.

Yarım asırlık 'güven'

Kalite yolculuğu inanmakla başlar.

Türkiye'nin ilk ve en büyük el aletleri üreticisi İZELTAŞ, 1968 yılında Ege'nin gözbebeği İzmir'den işte bu inançla yola çıktı. Yüzde 100 Türk sermayesiyle oluşturulan ve günden güne büyüyen İZELTAŞ, modern teknolojiyle donatılmış dev tesislerinde üretilen dört bin beş yüz den fazla ürünle 40 ülkeye ihracat yaparak hem kendi insanına hem de ülke ekonomisine katkı sağlıyor.

El aletlerinin yanı sıra üretilen dövme parçalar ile başta otomotiv olmak üzere inşaat, denizcilik ve madencilik sektörüne, savunma ve havacılık sanayilerine, ziraat endüstrisine, altyapı işlerine dek birçok kamu ve özel sektör kuruluşuna hizmet sunuyor.

Daha iyisi, daha yenisi için...

Kalıphane, dövme, işleme, ısıl işlem, krom-nikel kaplama, boyama, plastik daldırma, plastik enjeksiyon ve markalama departmanlarından oluşan dünyadaki ender entegre fabrikalardan İZELTAŞ'ta üretimin her aşamasında kalite kontrolüne tabi tutulan ürünler; fiziksel, metalürjik, kimyasal ve elektriksel testlerden geçirilerek İZELTAŞ güvencesine alınıyor. Ar-Ge ve inovasyon ışığında değişime ve gelişime her daim açık olan İZELTAŞ, bu sayede gücüne güç katıyor.

T.C. Sanayi ve Teknoloji Bakanlığında AR-GE Merkezi belgesine sahip İZELTAŞ, TS EN ISO 9001 Kalite Yönetim Sistemi, ISO/IEC 27001 Bilgi Güvenliği Yönetim Sistemi, TS (OHSAS) 18001 İş Sağlığı ve Güvenliği Yönetim Sistemi, TS EN ISO 14001 Çevre Yönetim Sistemi, TS EN ISO 50001 Enerji Yönetim Sistemleri; TSE, TSEK, VDE GS ürün kalite belgeleri ve yüksek teknolojisi ile sadece Türkiye'de değil, dünyada da farkını ortaya koyuyor.

Önce güvenlik, sonra üretim

İnsan önemli, emek değerlidir. İZELTAŞ, "Önce güvenlik" anlayışından ayrılmadan, çalışanları için önlem almaya, onları iş sağlığı ve güvenliği konusunda eğitmeye devam ediyor. Çünkü; "İnsan vücudunun yedek parçası yoktur"

Size ulaştıktan sonra...

Satış sonrasında tüketici haklarını koruma ve sınırsız hizmet anlayışı İZELTAŞ'ın vazgeçilmez şirket politikalarından birini oluşturuyor.

Dolayısıyla...

- El aletleri' dendiğinde akla gelen ilk isim olabildiysek,
- Yarım asırdır 'aileden biri' olmanın hakkını verebildiysek,
- 'Türk malı' sözünün altına imzamızı atabildiysek,
- 'Yıllarca kullanılır' diyerek her zaman tercih edildiysek,

Gücümüzü, şevkimizi ve inancımızı siz değerli bayilerimiz ve tüketicilerimizden alıyoruz.

850 çalışanımızla birlikte üreterek, değer sağlayarak dünya markası olmanın haklı gururunu yaşıyoruz.

Nice başarılı yıllara!

Half a century of reliability

Faith is the essential step on the journey to achieve utmost quality.

As the first and largest hand tool manufacturer of Turkey, İZELTAŞ, had this faith as it started its journey in 1968 in Izmir, the beautiful city in the Aegean region. Its establishment, consisting of 100% national capital, İZELTAŞ has grown in years into an industrial giant with huge facilities equipped with state-of-the-art technologies and over 4500 products. Exporting to more than 40 countries, the company is a prominent contributor to not only the Turkish economy but also the community.

Along with manufacturing hand tools, İZELTAŞ produces forged steel parts for various industries like automotive, construction, maritime, mining, aviation, defence, agriculture and infrastructure.

Newer and better

İZELTAŞ is one of the few fully integrated factories in the world that consists of die tooling, forging, processing, heat processing, chrome-nickel plating, dyeing, pvc coating, plastic injection and marking departments. Every stage of the production is tested for quality assurance using physical, metallurgical, chemical and electrical methods. R&D and innovation are the key words that empower İZELTAŞ as a company which embraces development and improvement as its main philosophy.

İZELTAŞ is an accredited R&D Center by the Ministry of Science, Industry and Technology and has been certified with the following: ISO 9001 Quality Management System, ISO/IEC 27001 Informationsecurity Management System, OHSAS 18001 Occupational Health and Safety Management System, ISO 14001 Environment Management System, ISO 50001 Energy Management System certification, TSE, TSEK and VDE GS product certification.

Safety before production

Humans are the most significant factors of any industry and their labour is precious. Health and safety awareness is the fundamental policy of İZELTAŞ. The company continuously organizes training programs on occupational health and safety which emphasise that safety comes first and it is not possible to fix humans by changing the damaged organs with spare ones.

Customer satisfaction

Another fundamental policy of İZELTAŞ is the customer satisfaction. The company is dedicated to serve its customers and protect their rights as consumers.

Hence...

- We are the first brand that comes to mind in the hand tools industry
- We are valued almost as a part of the families of our consumer
- We have proved ourselves worthy of the statement "Made in Turkey"
- We have been the first choice of the consumers for durability over the years

Our power, enthusiasm and faith are derived from our distinguished dealers and consumers.

We are proud to have become a world brand with our 850 employees who strive everyday to contribute to the productivity of the company, creating an added value for the economy and our community.

To many successful years to come!

Takım Dolapları ve Takım Çantaları
Tool Trolleys, Tool Boxes



5-37

1

Anahtarlar
Wrenches



38-60

2

Lokma ve Bijon Anahtarları
Sockets and Rim Wrenches



61-88

3

Boru Anahtarları ve Penseler
Pipe Wrenches and Pliers



89-108

4

1000V Grubu Ürünler
1000V Product Group



109-116

5

Tornavida ve Allen Anahtarlar
Screwdrivers and Hex Key Wrenches



117-140

6

Keskiler ve Çekiçler
Chisels and Hammers



141-148

7

Servis Alet ve Ekipmanları
Maintenance Tools and Equipment



149-160

8

Makaslar
Shears



161-168

9

Çektirmeler
Pullers



169-176

10

DIY Elta Tools



177-194

11

Yedek Parçalar
Spare Parts



195-200

12

Ticari Teşhir Standları
Commercial Display Stands



201-204

13

Teknik Bilgiler
Technical Information



205-214

14



*"Sadece el aleti üretmiyoruz;
el aletleriyle her şeyi üretiyoruz."*

*"We don't just produce hand tools;
we build everything with hand tools."*

IZELTAS®

TAKIM DOLAPLARI TAKIM ANTALARI VE ALET SETLERİ

TOOL TROLLEYS, TOOL BOXES AND
HAND TOOL SETS



Takim Dolapları
Tool Cabinets

Takim antaları
Tool Boxes

Servis Masaları
Service Tables

Alet Setleri
Tool Sets



8241 PRO SERİSİ / PRO SERIES

Pro Serisi Takım Dolabı (5-6-7-8 Çekmeceli)
Pro Series Workshop Trolley (5-6-7-8 Drawers)



Ölçü/Size: 470x670x1007 mm

Sacdan imal edilmiş, Fırın boya
Made of sheet metal, Electrostatic paint

✓ Merkezi kilit sistemi, mandal sistemi ve devrilme emniyet sistemi.
● Central lock system, handgrip lock system and antitilt system.



✓ Teleskobik rulmanlı kızaklar tüm çekmeceler %100 açılabilir.
● Telescopic slides which are %100 extendable.



✓ 8 bölmeli sağlam ve dayanıklı ABS plastik üst malzeme tabla.
● Durable ABS worktop with 8 divisions



✓ 2 sabit, 2 hareketli frenli tekerlek Ø 125mm
● 2 swivel castors with brake, 2 fixed castors Ø 125mm



✓ Yüksek dayanımlı elektrostatik toz boya.
● High strength electrostatic powder coating

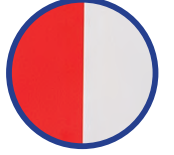

✓ Toplam 6 Adet yan ve arka avadanlık bölümleri.
● 6 tool holders

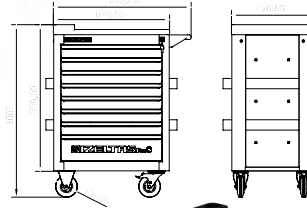

KOD/CODE	ÇEKMECE DRAWERS	35 kg	45 kg	45 kg	kg	RENK COLORS	FİYAT TL/Ad
8241 32 1005	5	1X	4X	--	59		2692,50
8241 32 1006	6	4X	1X	1X	62		2909,50
8241 32 1007	7	5X	2X	--	65	RAL 7035 RAL 3020	3438,35
8241 32 1008	8	7X	1X	--	67		3665,10
8241 32 2005	5	1X	4X	--	59		2692,50
8241 32 2006	6	4X	1X	1X	62	RAL 7035 RAL 5003	2909,50
8241 32 2007	7	5X	2X	--	65		3438,35
8241 32 2008	8	7X	1X	--	67		3665,10
8241 32 3005	5	1X	4X	--	59		2692,50
8241 32 3006	6	4X	1X	1X	62	RAL 7035 RAL 7016	2909,50
8241 32 3007	7	5X	2X	--	65		3438,35
8241 32 3008	8	7X	1X	--	67		3665,10
8241 00 1209 Dolu/Full 206 Parça/Pcs	8	7x	1x	--			8937,75

(★) İşaretili olan ürünler stoklarla sınırlıdır.
Limited with stocks.

1

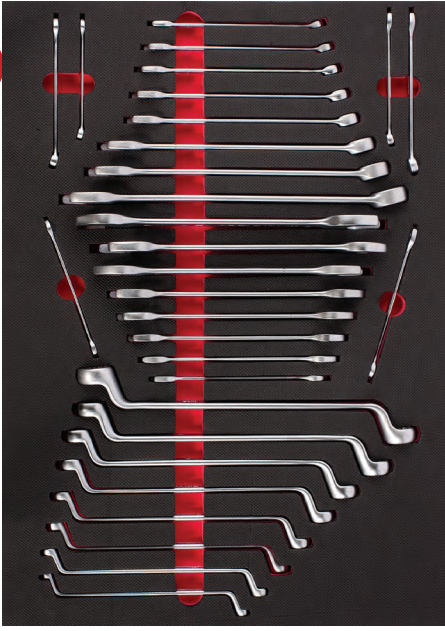

1

1. Pro Seri Çekmece/Drawer

Kod / Code 8241001030

KOD CODE	İÇERİK CONTENTS	□	FİYAT TL/Ad
0130	İki Ağız Anahtar Uzun Boy / D/E Open Jaw Wrench Long Pattern 6x7 - 8x9 - 10x11 - 12x13 14x15 - 16x17 - 18x19 - 20x22 21x23 - 24x26	10	
0330	Kombine Anahtar Uzun Boy / Combination Wrench Long Pattern 6 - 7 - 8 - 9 - 10 - 11 - 12 - 13 14 - 17 - 19 - 22	12	722,10
0430	Yıldız Anahtar / D/E Ring Wrench 6x7 - 8x9 - 10x11 - 12x13 14x15 - 16x17 18x19 - 20x22	8	

2



2. Pro Seri Çekmece/Drawer

Kod / Code 8241002072

KOD CODE	İÇERİK CONTENTS	□	FİYAT TL/Ad
1107	1/4" Altı Köşe Lokma Takımı / 1/4" Socket Wrench Set 4 - 5 - 6 7 - 8 - 9 - 10 11 - 12 - 13 Altı Köşe Six Point 1/4" Cırcır kolu / 1/4" Ratchet Handle 1/4" Mafsal / 1/4" Universal Joint 1/4" T Kol / 1/4" Sliding T Handle 1/4" Ara Kol / 1/4" Extension Bar 50 mm 1/4" Ara Kol / 1/4" Extension Bar 100 mm	15	
1113	1/2" Lokma Takımı / 1/2" Socket Wrench Set 10 - 11 - 12 13 - 14 - 15 16 - 17 - 18 19 - 21 - 22 23 - 24 - 26 27 - 28 - 30 32 1/2" Cırcır Kolu 32 Diş / 1/2" Ratchet Handle 1/2" Mafsal / 1/2" Universal Joint 1/2" T Kol Adaptör/ 1/2" Sliding T Handle Adapter 1/2" Ara Kol / 1/2" Extension Bar 125 mm 1/2" Ara Kol / 1/2" Extension Bar 250 mm	24	1422,20
1113	1/2" Lokmalı Allen Uçlar / 1/2" Hexagonal Bits Sockets H5-H6-H7-H8-H10-H12-H14	7	
1113	1/2" Lokmalı Star Uç / 1/2" Star Bits Socket T20-T25-T27-T30-T40-T45-T50-T55-T60	9	
0330	Kombine Anahtar Uzun Boy / Combination Wrench Long 16-18 mm	2	
4900	Allen Takımı 6 Köşe / Hex Key Wrench Set 2-2.5-3-3.5-4-5-6-7-8-9-10-12	12	

3



3. Pro Seri Çekmece/Drawer

Kod / Code 8241003051

KOD CODE	İÇERİK CONTENTS	□	FİYAT TL/Ad
07415	Sıralı Tel Fırça 3 Sıralı / Hand Brush 3 Raws	1	
6350	Levye Oluklu / Tyre Lever 400 mm	1	
6220	Spiralli Mıknatıs / Flexible Magnet Holder 500 gr	1	
4110	Düz Topaç Tornavida / Screwdriver , Stubby, Flat 6.5x25	1	
4130	Yıldız Topaç Tornavida / Screwdriver , Stubby, Phillips 6x25	1	617,75
4770	Lokma Uçlu Tornavida / Nutspinner 6-7-8-9-10-13	6	
4780	Manyetik Bits Tutucu Tornavida / Screwdriver, Magnetic Bit Holder 6.3x120	1	
4905	Yuvarlak Başlı Allen Takımı (Kutulu) / Hexkey Wrench Ballpoint Set 2-2.5-3-4-5-6-8-10 mm	8	
4800	Bits Set Takım (Kutulu) / Bits Set in metal case	31	

4. Pro Seri Çekmece/Drawer

Kod / Code 8241004027

1



KOD CODE	İÇERİK CONTENTS	☐	FİYAT TL/Ad
0340	Cırcır Kombine Anahtar / Combination Wrench With Ratchet 10-13-17-19 mm	4	
4909	T Tipi Torx Allen Anahtar / Torx Allen Key T type T9-T10-T15-T20-T25-T27-T30-T40	8	
1108	1/2" Altı Köşe Derin Lokma / 1/2" Deep Socket Wrench, six points 10-11-12-13-14-15-16-17-18-19	10	1060,55
1113	1/2" Altı Köşe Havalı Lokma / 1/2" Impact Socket Wrench 13-17-18-19-24 mm	5	

5. Pro Seri Çekmece/Drawer

Kod / Code 8241005010



KOD CODE	İÇERİK CONTENTS	☐	FİYAT TL/Ad
3331	İç Eğri Segman Pense / Circlip Pliers, Internal, Bent 170 mm	1	
3321	İç Düz Segman Pense / Circlip Pliers, Internal, Flat 180 mm	1	
3311	Dış Eğri Segman Pense / Circlip Pliers, External, Bent 170 mm	1	
3301	Dış Düz Segman Pense / Circlip Pliers, External, Flat 180 mm	1	
3700	Yan Keski Opak İzole / Side Cutting Pliers, 160 mm	1	939,45
3220	Düz Kargaburun Opak İzole / Nose Pliers, 200 mm	1	
3020	Kombine Pense Opak İzole / Combination Pliers, 180 mm	1	
2510	Special Ayarlı Pense / Special Grip 250 mm	1	
0600	Kurbağacık Anahtar / Adjustable Jaw Wrench 10"	1	
2400	Üniversal Fort Pense / Universal Grip 240 mm	1	

6. Pro Seri Çekmece/Drawer

Kod / Code 8241006018



KOD CODE	İÇERİK CONTENTS	☐	FİYAT TL/Ad
4300	Opak Seri Düz Uçlu Tornavida / Opak Screwdriver, Flat 4x100-5x125-6x150-8x175	4	
4320	Opak Seri Yıldız Uçlu Tornavida / Opak Screwdriver, Phillips 4.5x80-6x100	2	
5800	Tesviyeci Çekiç / Mechanist Hammer 300 gr	1	
5850	Plastik Çekiç / Plastic Hammer ø30	1	510,60
5545	Konik Pim Zimba / Drift Punch 5 mm	1	
5550	Düz Pim Zimba / Split Pin Punch 5 mm	1	
5540	Nokta Zimba / Center Punch 5x120	1	
5500	Düz Keski / Flat Cold Chisel 150 mm	1	
4920	T Tipi Allen Anahtar / T Type Hex Key Wrench 3-4-5-6-7-8	6	

(★) İşaretili olan ürünler stoklarla sınırlıdır.
Limited with stocks.



8245 PREMIUM SERİSİ / PREMIUM SERIES

Premium Serisi Takım Dolabı (5-7 Çekmeceli)
Premium Series Workshop Trolley (5-7 Drawers)



✓ 6 bölmeli sağlam ve dayanıklı ABS plastik üst malzeme tabla.
● Resistant and solid top cover having 6 divisions



✓ %100 açılabilir teleskobik raylar.
● %100 extendable telescopic slides



✓ Merkezi kilit
✓ Mandal sistemi
✓ Devrilme emniyet sistemi
● Central lock
● Handgrip Lock system
● Anti tilt system



✓ 2 sabit, 2 hareketli frenli tekerlek ø 125mm
● 2 swivel castors with brake
2 fixed castors ø 125mm



✓ Standard tutma sapı
● Standard handle



✓ Plastik köşe koruma
● Plastic corner protection



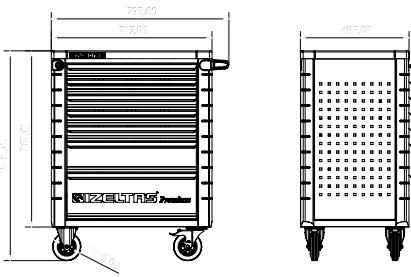
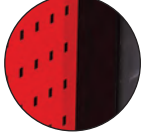

✓ Yüksek dayanımlı elektrostatik toz boya.
● High strength electrostatic powder coating.



Ölçü/Size: 485x717x944 mm

Sacdan imal edilmiş, Fırın boya
Made of sheet metal, Electrostatic paint



KOD/CODE	ÇEKMECE DRAWERS				Kg	RENK COLORS	FİYAT TL/Ad
8245 32 1005	5	400x548x62	400x548x132	400x548x201			2604,10
8245 32 1007	7					RAL 9005 RAL 3020	3371,25
8245 00 7096 Dolu/Full 242 Parça/Pcs	7						10408,20

1

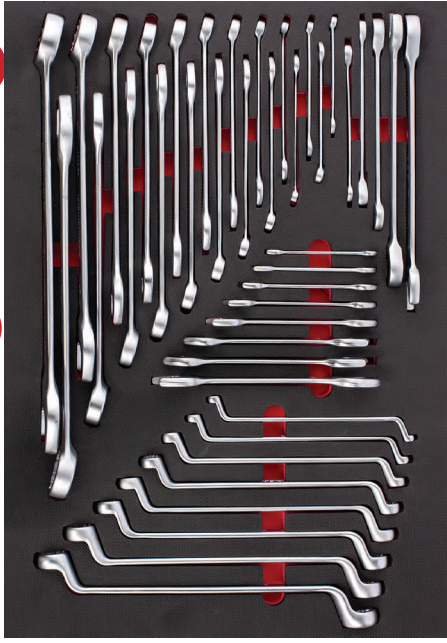

1

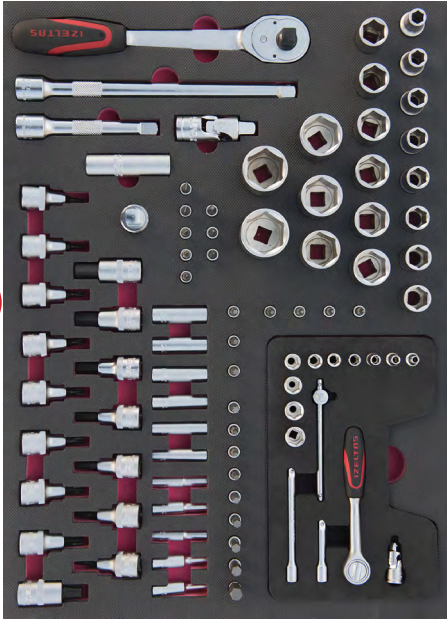

2



3

1. Premium Seri Çekmece/Drawer Kod / Code 8245001042

KOD CODE	İÇERİK CONTENTS	□	FIYAT TL/Ad
0100	İki Ağız Anahtar Kısa Boy D/E Open jaw wrenches Short Pattern 6x7-8x9-10x11-12x13-14x15-16x17-18x19-20x22	8	
0320	Kombine Anahtar Kısa Boy Combination wrenches Short Pattern 6-7-8-9-10-11-12-13-14-15-16-17-18-19-20-21-22-24-27-30-32	21	1345,80
0430	Yıldız Anahtar Ring Wrenches 6x7-8x9-10x11-12x13-14x15-16x17-18x19-20x22	8	
0340	Cırcır Kombine Anahtar / Combination Wrench With Ratchet 8-10-13-17-19 mm	5	

2. Premium Seri Çekmece/Drawer Kod / Code 8245002094

KOD CODE	İÇERİK CONTENTS	□	FIYAT TL/Ad
1107	1/4" Lokmalı Allen Uçlar / Hexagonal Bits Socket 2,5 - 3 - 4 - 5 - 6 - 7 - 8 - 10	8	
1107	1/4" Lokmalı Torx Uç / Torx Bits Socket T8-T9-T10-T15-T20-T25-T27-T30-T40	9	
1107	1/4" Lokmalı Yıldız Uç / Phillips Bits Socket PH1-PH2-PH3	3	
1107	1/4" Lokmalı Düz Uç / Slotted Bits Socket 3 - 4 - 5,5 - 6,5	4	
1107	1/4" Altı Köşe Derin Lokma / Deep Socket Wrench 6 Point 4-5-5,5-6-7-8-9-10-11-12-13	11	
1113	1/2" Lokmalı Allen Uç Takım / Hexagonal Bits Socket 5-6-7-8-10-12-14	7	
1113	1/2" Lokmalı Torx Uç Takım / Torx Bits Socket T20-T25-T27-T30-T40-T45-T50-T55-T60	9	
1107	1/4" Altı Köşe Lokma Takımı / Socket Wrench Set 1/4" Cırcır kolu / Ratchet Handle 1/4" Mafsal / Universal Joint 1/4" T Kol / Sliding T Handle	15	1576,75
1113	1/4" Ara Kol / Extention Bar 50-100 mm 1/2" Buji Lokma Lastikli Spark Plug Socket With Rubber 16 mm 1/2" Lokma Takımı / Socket Wrench Set 1/2" Cırcır Kolu 32 Diş / Ratchet Handle 1/2" Mafsal / Universal Joint	1	
1113	1/2" T Kol Adaptör / Sliding T Handle Adapter 1/2" Ara Kol / Extension Bar 125 mm 1/2" Ara Kol / Extension Bar 250 mm	24	

3. Premium Seri Çekmece/Drawer Kod / Code 8245003014

KOD CODE	İÇERİK CONTENTS	□	FIYAT TL/Ad
3700	Yan Keski Opak İzole / Side Cutting Pliers 160 mm	1	
3020	Kombine Pense Opak İzole / Combination Pliers 180 mm	1	
3220	Düz Kargaburun Opak İzole / Nose Pliers Flat 180 mm	1	
4300	Opak Seri Düz Uçlu Tornavida / Screwdriver, Flat 3x80-5x125-7x150mm	3	
4320	Opak Seri Yıldız Uçlu Tornavida / Screwdriver, Phillips 3x60-4.5x80-6x100-8x150mm	4	704,85
3301	Dış segman Pensi Yaylı Düz / Circlip Pliers, External Flat 140-180mm	2	
3321	İç segman Pensi Yaysız Düz / Circlip Pliers, Internal Flat 140-180mm	2	

4. Premium Seri Çekmece/Drawer Kod / Code 8245004043

KOD CODE	İÇERİK CONTENTS	☐	FİYAT TL/Ad
4770	Lokma Uçlu Tornavida / Nutspinner 6-7-8-9-10-13	6	775,65
4910	Torx Allen Takım / Torx Key Wrench Set T9-T10-T15-T20-T25-T27-T30-T40	8	
4900	Allen Takımı 6 Köşe / Hex Key Wrench Set 2-2.5-3-3.5-4-5-6-7-8-9-10-12	12	
4906	Yuvarlak Başlı Uzun Allen Takımı / Hex key Wrench Ballpoint Long Pattern Set 1,5-2-2,5-3-4-5-6-8-10 mm	9	
4920	T Tipi Allen Anahtar / T Type Hex Key Wrench 2.5-3-4-5-6-7-8-10	8	

5. Premium Seri Çekmece/Drawer Kod / Code 8245005043

KOD CODE	İÇERİK CONTENTS	☐	TL/Ad.
4565	Oto Elektrik Kontrol Kalemi Car Voltage Tester 135mm	1	853,00
07415	Sıralı Tel Fırça 4 Sıralı / Hand Brush 4 Rows	1	
2400	Üniversal Fort Pense PVC / Universal Grip 240 mm	1	
2500	Üniversal Ayarlı Pense Universal Grip 250 mm	1	
0600	Kurbağacık Anahtar / Adjustable Wrench 10"	1	
4780	Manyetik Bits Tutucu Tornavida / Screwdriver, Magnetic Bit Holder 6.3x120	1	
4800	31'li Bits Takım (Plastik Kutulu) / Bits Set in plastic case	31	
4110	Düz Topaç Tornavida / Screwdriver, Stubby, Flat 6.5x25	1	
4130	Yıldız Topaç Tornavida / Screwdriver, Stubby, Phillips 6x25	1	
5500	Düz Keski Krom Flat Cold Chisel 150 mm	1	
5800	Tesviyeci Çekici Machinist's Hammer 300-1500 gr	2	
6350	Levye Oluklu / Tyre Lever 500 mm	1	

6. Premium Seri Çekmece/Drawer Kod / Code 8245006009

KOD CODE	İÇERİK CONTENTS	☐	FİYAT TL/Ad
1855	Mafsallı T Kol Lokma T- Handle Wrench with Universal Join 8-10-12-13-17-19	6	1780,90
6230	Gres Pompası Grease Gun 500cc	1	
06375	Ayarlı Yağ Filtre Sökeceği Adjustable Slot Type Oil Filter Wrench	1	
6225	Madeni Yağdanlık (Flexible Uçlu) Oiler With Flexible Spout 200cc	1	





8242 GARAJ SERİSİ / GARAGE SERIES

Garaj Serisi Takım Dolabı (5-6-7-8 Çekmeceli)
Garage Series Workshop Trolley (5-6-7-8 Drawers)

1



✓ Ergonomik sap
● Ergonomic handle



✓ 8 Bölmeli, sağlam ABS tabla
● Durable ABS worktop with divisions



✓ Havluluk x1
Avadanlık x2 Askılık x1
● Paper Roll Holder
x1 Bottle & Tins Holder x2 Hanger x1



✓ %100 açılabilir teleskobik raylar
● %100 extendable telescopic slides

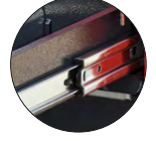

✓ Merkezi kilit sistemi, mandal sistemi devrilme emniyet sistemi.
● Central locking, system handgrip lock system antitilt system



✓ 2 sabit, 2 hareketli frenli tekerlek Ø 125mm
● 2 swivel castors with brake 2 fixed castors Ø 125 mm



✓ Yüksek dayanımlı elektrostatik toz boya.
● High strength electrostatic powder coating

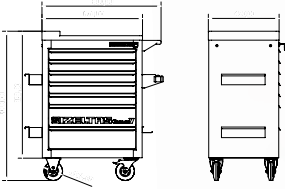

Ölçü/Size: 470x670x1010 mm

Sacdan imal edilmiş, Fırın boya
Made of sheet metal, Electrostatic paint



RAL 7016
RAL 3020

RAL 7016
RAL 5003

RAL 7016
RAL 7035

KOD/CODE	ÇEKMECE DRAWERS	35 kg	45 kg	45 kg	kg	RENK COLORS	FİYAT TL/Ad
		400x548x68	400x548x143	400x548x218			
8242 32 1005	5	1X	4X	--	59		2405,85
8242 32 1006	6	4X	1X	1X	62	RAL 7016 RAL 3020	2831,85
8242 32 1007	7	5X	2X	--	65		3308,70
8242 32 1008	8	7X	1X	--	67		3632,20
8242 32 2005	5	1X	4X	--	59		2405,85
8242 32 2006	6	4X	1X	1X	62	RAL 7016 RAL 5003	2831,85
8242 32 2007	7	5X	2X	--	65		3308,70
8242 32 2008	8	7X	1X	--	67		3632,20
8242 32 3005	5	1X	4X	--	59		2405,85
8242 32 3006	6	4X	1X	1X	62	RAL 7016 RAL 7035	2831,85
8242 32 3007	7	5X	2X	--	65		3308,70
8242 32 3008	8	7X	1X	--	67		3632,20
8242 00 1142 Dolu/Full 139 Parça/Pcs	7	5X	2X	--			7303,45
8242 00 8142 Dolu/Full 139 Parça/Pcs	8	7X	1X	--			7626,95

1

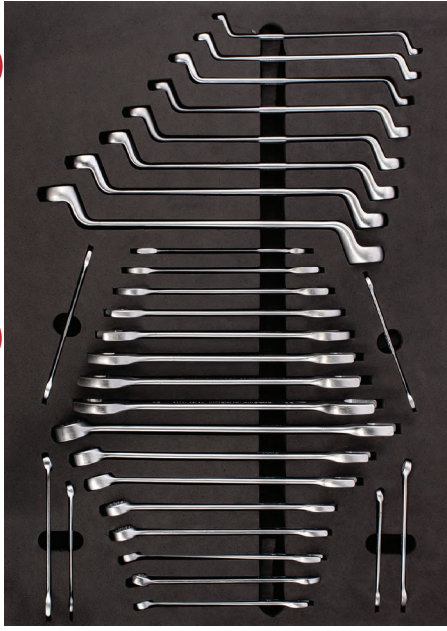

1

1. Garaj Seri Çekmece/Drawer

Kod / Code 8242001030

KOD CODE	İÇERİK CONTENTS	□	FİYAT TL/Ad
0130	İki Ağız Anahtar Uzun Boy D/E Open Jaw Wrench Long Pattern 6x7 - 8x9 - 10x11 - 12x13 14x15 - 16x17 - 18x19 - 20x22 - 21x23 - 24x26	10	
0330	Kombine Anahtar Uzun Boy Combination Wrenches Long Pattern 6 - 7 - 8 - 9 - 10 - 11 - 12 - 13 - 14 - 17 - 19 - 22	12	722,10
0430	Yıldız Anahtar Ring Wrench 6x7 - 8x9 - 10x11 - 12x13 - 14x15 - 16x17 18x19 - 20x22	8	

2. Garaj Seri Çekmece/Drawer

Kod / Code 8242002072

2



KOD CODE	İÇERİK CONTENTS	□	FİYAT TL/Ad
1113	1/2" Lokmalı Allen Uçlar Hexagonal Bits Socket H5-H6-H7-H8-H10-H12-H14	7	
1113	1/2" Lokmalı Star Uç / 1/2 Star Bits Socket T20-T25-T27-T30-T40-T45-T50-T55-T60	9	
0330	Kombine Anahtar Uzun Boy Combination Pliers Long 16-18 mm	2	
4900	Allen Takımı Altı Köşe / Hex Key Wrench Set 2-2.5-3-3.5-4-5-6-7-8-9-10-12	12	
1107	1/4" Altı Köşe Lokma Takımı Socket Wrench Set 1/4" Cırcır Kolu Ratchet Handle 4 - 5 - 6 7 - 8 - 9 - 10 11 - 12 - 13 Altı Köşe Six Points	15	1422,20
1113	1/4" T Kol / Sliding T Handle 1/4" Ara Kol / Extension Bar 50 mm 1/4" Ara Kol Extension Bar 100 mm 1/2" Lokma Takımı Socket Wrench Set 1/2" Cırcır Kolu 32 Diş Ratchet Handle 10 - 11 - 12 13 - 14 - 15 16 - 17 - 18 19 - 21 - 22 23 - 24 - 26 27 - 28 - 30 32 Altı Köşe Six Points 1/2" Mafsal Universal Joint 1/2" T Kol Adaptör Sliding T Handle Adapter 1/2" Ara Kol Extension Bar 125 mm 1/2" Ara Kol Extension Bar 250 mm	24	

3. Garaj Seri Çekmece/Drawer

Kod / Code 8242003010

1



KOD CODE	İÇERİK CONTENTS	☐	FİYAT TL/Ad
3331	İç Eğri Segman Pense Circlip Pliers Internal (Bent) 170 mm	1	939,45
3321	İç Düz Segman Pense Circlip Pliers Internal (Flat) 180 mm	1	
3311	Dış Eğri Segman Pense Circlip Pliers External (Bent) 170 mm	1	
3301	Dış Düz Segman Pense Circlip Pliers External (Flat) 180 mm	1	
3700	Yan Keski Opak İzole Side Cutting Pliers 160 mm	1	
3220	Düz Kargaburun Opak İzole Nose Pliers (Flat) 200 mm	1	
3020	Kombine Pense Opak İzole Combination Pliers 180 mm	1	
2510	Special Ayarlı Pense / Universal Grip 250 mm	1	
0600	Kurbağacık Anahtar / Adjustable Wrench 10"	1	
2400	Üniversal Fort Pense / Waterpump Pliers Üniversal 240 mm	1	

4. Garaj Seri Çekmece/Drawer

Kod / Code 8242004018



KOD CODE	İÇERİK CONTENTS	☐	FİYAT TL/Ad
4300	Opak Seri Düz Uçlu Tornavida Screwdriver, Opak Flat 5x125-4x100-6x150-8x175	4	510,60
4320	Opak Seri Yıldız Uçlu Tornavida Screwdriver, Opak Phillips 4.5x80-6x100	2	
5800	Tesviyeci Çekiç Machinist's Hammer 300 gr	1	
5850	Plastik Çekiç Plastic Hammer ø30	1	
5545	Konik Pim Zimba Drift Punch 5 mm	1	
5550	Düz Pim Zimba Split Pin Punch 5 mm	1	
5540	Nokta Zimba Center Punch 5x120	1	
5500	Düz Keski Flat Cold Chisel 150 mm	1	
4920	T Tipi Allen Anahtar / Hex Key Wrench 3-4-5-6-7-8	6	

5. Garaj Seri Çekmece/Drawer

Kod / Code 8242005011



KOD CODE	İÇERİK CONTENTS	☐	FİYAT TL/Ad
07415	Sıralı Tel Fırça 3 Sıralı Hand Brush 3 Raws	1	400,40
6350	Levyeye Oluklu Tyre Lever, Straight 400 mm	1	
6220	Spiralli Mıknatıs Flexible Magnet Holder 500 gr	1	
4110	Düz Topaç Tornavida Screwdriver Stubby Flat 6.5x25	1	
4130	Yıldız Topaç Tornavida Screwdriver Stubby Phillips 6x25	1	
4770	Lokma Uçlu Tornavida Nut Spinner 6-7-8-9-10-13	6	



8235 PARTNER SERİSİ / PARTNER SERIES

1

Partner Mobil Takım Dolabı (5 Çekmeceli)
Partner Workshop Trolley (5 Drawers)



- ✓ Merkezi kilit.
- Central lock system



- ✓ %100 açılabilir, kendinden frenli teleskobik ray
- %100 extendable telescopic soft close slides



- ✓ 8 Bölmeli, sağlam ABS tabla
- 8 Durable ABS worktop with divisions



- ✓ 2 sabit, 2 hareketli frenli tekerlek ø 100mm
- 2 swivel castors with brake
- 2 fixed castors ø 100 mm

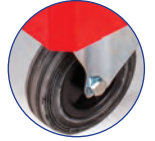

- ✓ Yüksek dayanımlı elektrostatik toz boya.
- High strength electrostatic powder coating



Ölçü/Size: 470x670x975 mm

Sacdan imal edilmiş, Fırın boya
Made of sheet metal, Electrostatic paint

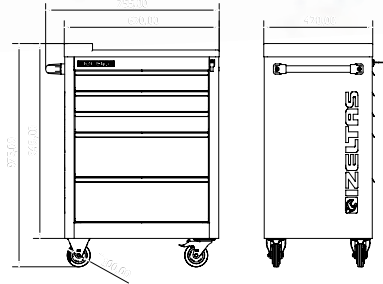

RAL 3020



RAL 5003



RAL 9005

KOD/CODE	ÇEKMECE DRAWERS	35 kg	45 kg	kg	RENK COLORS	FİYAT TL/Ad
8235 32 6005	5	3X	2X	56	RAL 3020	2188,85
8235 32 5005	5	3X	2X	56	RAL 5003	2188,85
8235 32 7005	5	3X	2X	56	RAL 9005	2188,85
8235 00 6121 Dolu/Full 118 Parça/Pcs	5	3X	2X			5148,90

1



1



1. Partner Seri Çekmece/Drawer

Kod / Code 8235001072

KOD CODE	İÇERİK CONTENTS	□	FİYAT TL/Ad
1107	<p>1/4" Altı Köşe Lokma Takımı 1/4" Socket Wrench Set</p> <p>1/4" Cırcır kolu Ratchet Handle</p> <p>1/4" Mafsal Universal Joint</p> <p>1/4" T Kol Sliding T Handle</p> <p>1/4" Ara Kol Extention Bar 50 mm</p> <p>1/4" Ara Kol Extention Bar 100 mm</p> <p>4 - 5 - 6 7 - 8 - 9 - 10 11 - 12 - 13 Altı Köşe Six Points</p>	15	
1113	<p>1/2" Lokma Takımı 1/2" Socket Set</p> <p>1/2" Cırcır Kolu 32 Diş Ratchet Handle</p> <p>1/2" Mafsal Universal Joint</p> <p>1/2" T Kol Adaptör Sliding T Handle Adapter</p> <p>1/2" Ara Kol Extention Bar 125 mm</p> <p>1/2" Ara Kol Extention Bar 250 mm</p> <p>10 - 11 - 12 - 13 14 - 15 16 - 17 - 18 19 - 21 - 22 23 - 24 - 26 - 27 - 28 30 - 32</p>	24	1577,35
1507	<p>1/4" Derin Lokma Tornavida Adaptörü Spindle Handle</p>	1	
4900	<p>12 'li Allen Anahtar Takımı Hex Key Wrench Set 2-2.5-3-3.5-4-5-6-7-8-9-10-12 mm</p>	12	
4910	<p>8 'li Torx Allen Anahtar Takımı Torx Key Wrench 6 Point T9-T10-T15-T20-T25-T27-T30-T40</p>	8	
1108	<p>1/2" Altı Köşe Derin Lokma Deep Socket Wrench 6 Point 10-13-16-17-18-19 mm</p>	6	
1113	<p>1/2" 16 mm Buji Lokma Anahtar Spark Plug Socket With Rubber</p>	1	
2400	<p>240 mm Üniversal Fort Pense Waterpump Pliers, Universal</p>	1	
2500	<p>250 mm Üniversal Ayarlı Pense Universal Grip</p>	1	

2. Partner Seri Çekmece/Drawer

Kod / Code 8235002031

1

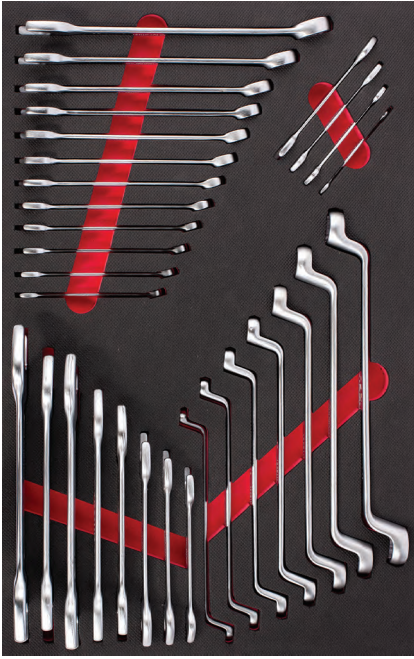

KOD CODE	İÇERİK CONTENTS	□	FİYAT TL/Ad
0100	İki Ağız Anahtar Kısa Boy Double Ended Open Jaw Wrench Short Pattern 6x7 - 8x9 - 10x11 - 12x13 14x15 - 16x17 - 18x19 - 20x22 21x23 - 24x26 - 25x28 - 30x32	12	716,00
0320	Kombine Anahtar Kısa Boy Combination Wrench Short Pattern 8 - 9 - 10 - 11 - 12 - 13 14 - 15 -16- 17 - 19 - 22	12	
0430	Yıldız Anahtar Ring Wrench 8x9 - 10x11 - 12x13 - 14x15 - 16x17 18x19 - 20x22	7	

2

3. Partner Seri Çekmece/Drawer

Kod / Code 8235003017



KOD CODE	İÇERİK CONTENTS	□	FİYAT TL/Ad
4300	Opak Seri Düz Uçlu Tornavida Screwdriver, Opak Flat 3x80-4x80-4x100-5x125-6x150	5	666,70
4320	Opak Seri Yıldız Uçlu Tornavida Screwdriver, Opak Philips 4.5x80-6x100	2	
3700	Yan Keski Opak İzole Side Cutting Pliers 160 mm	1	
3020	Kombine Pense Opak İzole Combination Pliers 180 mm	1	
3220	Düz Kargaburun Opak İzole Nose Pliers Flat 200 mm	1	
4770	Lokma Uçlu Tornavida Nut Spinner 6-7-8-10-13	5	
5500	Düz Keski Flat Cold Chisel 150 mm	1	
5800	Tesviyecci Çekiçi Machinist's Hammer 500 gr	1	

3



1

Eko Serisi Takım Dolabı (5-7 Çekmeceli)
Eco Series Workshop Trolley (5-7 Drawers)

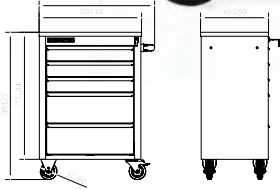

Ölçü/Size: 410x620x894 mm



✓ 4 bölmeli sağlam ve dayanıklı ABS plastik üst malzeme tabla.
● Resistant and solid top cover with 4 divisions



✓ %100 açılabilir teleskobik raylar.
● %100 extendable telescopic slides



✓ Merkezi kilit
● Central locking



✓ 2 sabit, 2 hareketli frenli tekerlek ø 100 mm
● 2 swivel castors with brake
2 fixed castors ø 100 mm





✓ Yüksek dayanımlı elektrostatik toz boya.
● High strength electrostatic powder coating

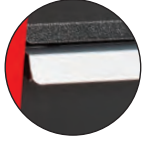

✓ Elokсалlı alüminyum tutma çantası.
● Handle with anodised aluminum



Sacdan imal edilmiş, Fırın boya
Made of sheet metal, Electrostatic paint

KOD/CODE	ÇEKMECE DRAWERS	 35 kg	 45 kg	Kg	RENK COLORS	FİYAT TL/Ad
		350x503x82	400x503x176			
8243 32 1005	5	3X	2X	43	RAL 7016 RAL 3020	1596,75
8243 32 1007	7	7X	--	43		2140,70
8243 32 2005	5	3X	2X	43	RAL 7016 RAL 5003	1596,75
8243 32 2007	7	7X	--	43		2140,70
8243 32 3005	5	3X	2X	43	RAL 7035 RAL 7016	1596,75
8243 32 3007	7	7X	--	43		2140,70
8243 00 1096 Dolu/Full 93 Parça/Pcs	5	3X	2X			3946,45
8243 00 7096 Dolu/Full 93 Parça/Pcs	7	3x	--			4490,40

(★) İşaretili olan ürünler stoklarla sınırlıdır.
Limited with stocks.

1. Eko Seri Çekmece/Drawer

Kod / Code 8243001030

1

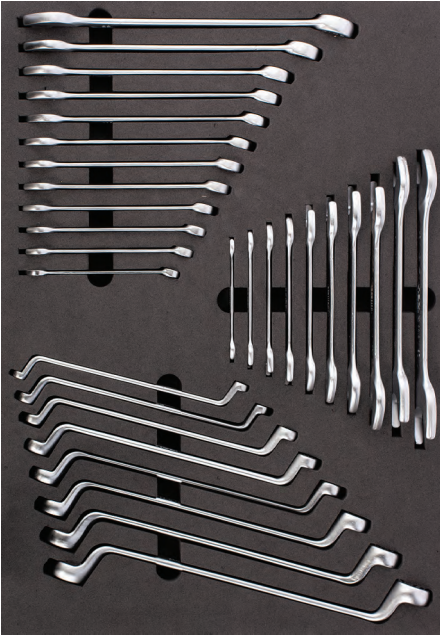

KOD/CODE	İÇERİK CONTENTS	☐	TL/Ad.
0100	İki Ağız Anahtar Kısa Boy D/E Open Jaw Wrench Short Pattern 6x7 - 8x9 - 10x11 - 12x13 14x15 - 16x17 - 18x19 - 20x22 - 21x23 - 24x26	10	
0320	Kombine Anahtar Kısa Boy Combination Wrench Short Pattern 8 - 9 - 10 - 11 - 12 - 13 - 14 - 15 - 16 - 17 - 19 - 22	12	677,50
0430	Yıldız Anahtar Ring Wrench 6x7 - 8x9 - 10x11 - 12x13 - 14x15 - 16x17 18x19 - 20x22	8	

2. Eko Seri Çekmece/Drawer

Kod / Code 8243002052



KOD/CODE	İÇERİK CONTENTS	☐	TL/Ad.
1113	1113 1/2" 17'li Lokma Takımı Socket Wrench Set 1/2" mm 10 - 11 - 12 - 13 - 14 - 15 - 17 - 19 22 - 24 - 27 - 30 - 32 250 - 250 - 70	17	
1107	1/2" T Kol Adaptör Sliding T Handle Adapte		
1107	1/4" Altı Köşe Lokma Takımı Socket Wrench Set 1/4" mm 4 - 5 - 6 - 7 - 8 - 9 - 10 - 11 - 12 - 13 140 - 115 - 100 - 50 - 38	15	1003,65
4900	Allen Anahtar Takımı Hex Key Wrench Set 2 - 2.5 - 3 - 3.5 - 4 - 5 - 6 - 7 - 8 - 9 - 10 - 12	12	
4770	Lokma Uçlu Tornavidalar Nutspinners 6 - 7 - 8 - 10 - 13	5	

3. Eko Seri Çekmece/Drawer

Kod / Code 8243003013



KOD/CODE	İÇERİK CONTENTS	☐	TL/Ad.
4320	Opak Yıldız Uçlu Tornavida Opak Screwdriver, Phillips 4,5x80-6x100 mm	2	
4300	Opak Düz Uçlu Tornavida Opak Screwdriver, Flat 4x100-5x125-6x150-8x175 mm	4	
3700	Yan Keski Opak Side Cutting Pliers 160 mm	1	
3020	Kombine Pense Opak Combination Pliers 180 mm	1	
3220	Kargaburun Düz Uçlu Opak Nose Pliers, Flat 160 mm	1	668,55
5500	Düz Keski Krom Flat Cold Chisel 150 mm	1	
5800	Tesviyeci Çekici Machinist's Hammer 300 gr	1	
2510	Spesiyel Ayarlı Pense / Waterpump Pliers Special 250 mm	1	
2400	Üniversal Fort Pense PVC / Universal Grip 240 mm	1	

1

Trend Serisi Takım Dolabı (5-7 Çekmeceli)
Trend Series Workshop Trolley (5-7 Drawers)



✓ 4 bölümlü sağlam ve dayanıklı ABS plastik üst malzeme tabla.
● Resistant and solid top cover with 4 divisions

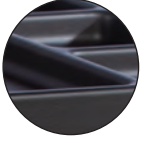

✓ %100 açılabilir teleskobik raylar.
● %100 extendable telescopic slides



✓ Merkezi kilit
● Central locking



✓ 2 sabit, 2 hareketli frenli tekerlek ø 100 mm
● 2 swivel castors with brake
2 fixed castors ø 100 mm



✓ Yüksek dayanımlı elektrostatik toz boya
● High strength electrostatic powder coating





✓ Kendiliğinden açılmayı engelleyen plastik kilit
● Plastic lock preventing self opening

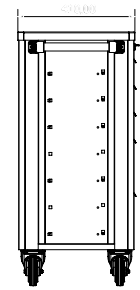
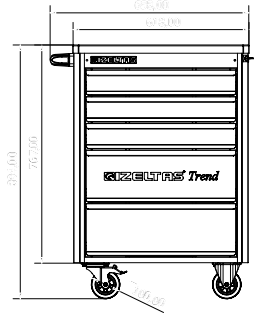

Ölçü/Size: 410x618x894 mm



Sacdan imal edilmiş, Fırın boya
Made of sheet metal, Electrostatic paint

KOD/CODE	ÇEKMECE DRAWERS	 350x503x82	 400x503x176	 Kg	RENK COLORS	FİYAT TL/Ad
8244 32 1005	5	3X	2X	43	RAL 9005 RAL 3020	1268,70
8244 32 1007	7	7X	--	43		1669,25
8244 00 5096 Dolu/Full 93 Parça/Pcs	5	3X	2X			3618,40
8244 00 7096 Dolu/Full 93 Parça/Pcs	7	7X	--			4018,95

1. Trend Seri Çekmece/Drawer Kod / Code 8244001030

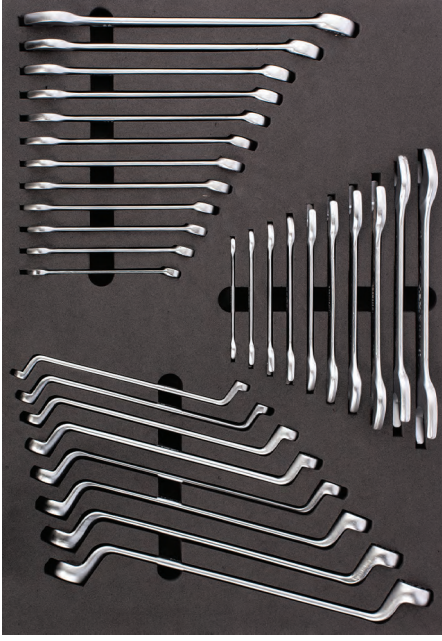

KOD/CODE	İÇERİK CONTENTS	TL/Ad.
0100	İki Ağız Anahtar Kısa Boy D/E Open Jaw Wrench Short Pattern 6x7 - 8x9 - 10x11 - 12x13 14x15 - 16x17 - 18x19 - 20x22 - 21x23 - 24x26	10
0320	Kombine Anahtar Kısa Boy Combination Wrench Short Pattern 8 - 9 - 10 - 11 - 12 - 13 - 14 - 15 - 16 - 17 - 19 - 22	12
0430	Yıldız Anahtar Ring Wrench 6x7 - 8x9 - 10x11 - 12x13 - 14x15 - 16x17 18x19 - 20x22	8

2. Trend Seri Çekmece/Drawer Kod / Code 8244002052



KOD/CODE	İÇERİK CONTENTS	TL/Ad.
1113	1/2" 17'li Lokma Takımı Socket Wrench Set 1/2" mm 10 - 11 - 12 - 13 - 14 - 15 - 17 - 19 22 - 24 - 27 - 30 - 32 250 - 250 - 70	17
1107	1/4" Altı Köşe Lokma Takımı Socket Wrench Set 1/4" mm 4 - 5 - 6 - 7 - 8 - 9 - 10 - 11 - 12 - 13 140 - 115 - 100 - 50 - 38	15
4900	Allen Anahtar Takımı Hex Key Wrench Set 2 - 2.5 - 3 - 3.5 - 4 - 5 - 6 - 7 - 8 - 9 - 10 - 12	12
4770	Lokma Uçlu Tornavidalar Nutspinners 6 - 7 - 8 - 10 - 13	5

3. Trend Seri Çekmece/Drawer Kod / Code 8244003013



KOD/CODE	İÇERİK CONTENTS	TL/Ad.
4320	Opak Yıldız Uçlu Tornavida Opak Screwdriver, Phillips 4.5x80-6x100 mm	2
4300	Opak Düz Uçlu Tornavida Opak Screwdriver, Flat 4x100-5x125-6x150-8x175 mm	4
3700	Yan Keski Opak Side Cutting Pliers 160 mm	1
3020	Kombine Pense Opak Combination Pliers 180 mm	1
3220	Kargaburun Düz Uçlu Opak Nose Pliers, Flat 160 mm	1
5500	Düz Keski Krom Flat Cold Chisel 150 mm	1
5800	Tesviyecici Çekici Machinist Hammer 300 gr	1
2510	Special Ayarlı Pense / Waterpump Pliers Special 250 mm	1
2400	Üniversal Fort Pense PVC / Universal Grip 240 mm	1

1

Vagon Serisi Takım Dolabı
Wagon Series Workshop Trolley

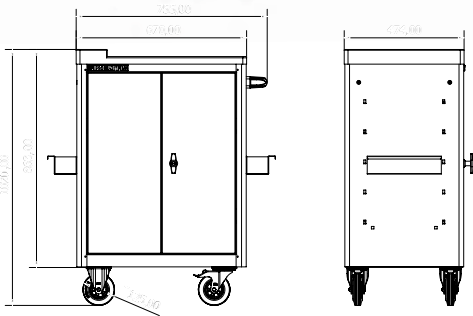

- ✓ 8 Bölmeli, sağlam ABS tabla
- Durable ABS worktop with divisions

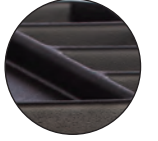

- ✓ Kilitli T kol
- Locked T-handle

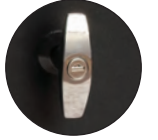

- ✓ 2 Sabit, 2 hareketli frenli tekerlek ø 125mm
- 2 swivel castors with brake 2 fixed castors ø 125 mm



- ✓ Yüksek dayanımlı elektrostatik toz boya.
- High strength electrostatic powder coating



- ✓ 2X ayarlanabilir raf (10 adet seperatör ile)
- 2x adaptable shelves with separator 10 pcs



- ✓ Standard tutma sapı
- Standard handle



- ✓ 2X avadanlık
- 2X tin holder



RAL 7016
RAL 3020

Ölçü/Size: 474x670x1020 mm

Sacdan imal edilmiş, Fırın boya
Made of sheet metal, Electrostatic paint

KOD/CODE	Ölçü / SIZE (mm)	KG	RENK COLORS	FİYAT TL/AD
----------	------------------	----	-------------	-------------

8210 32 6001

470x670x1020

45

RAL 7016
RAL 3020

1425,30

8160 TAKIM DOLABI / TOOL CABINET

Takım Dolabı
Tool Cabinet

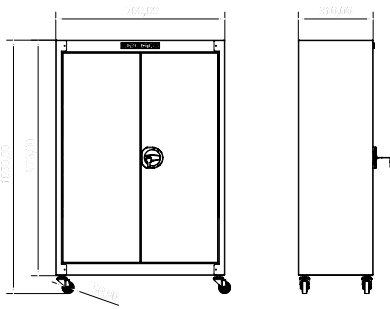

Ölçü/Size: 310x700x1050 mm

Sacdan imal edilmiş, Fırın boyası
Made of sheet metal, Electrostatic paint

✓ Kilit T kol
● Locked T-handle



✓ %100 açılabilir teleskobik raylar.
● %100 extendable telescopic slides



✓ 2 hareketli frenli tekerlek ø 50mm
● 2 swivel castors with brake ø 50 mm



✓ Yüksek dayanımlı elektrostatik toz boya.
● High strength electrostatic powder coating

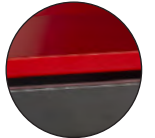

✓ Avadanlık x2
● Bottle and tins holder x2



✓ Askılık x4
● Hanger x4



✓ Özel askılık x4
● Special hanger x4



✓ Anahtar askısı x1
● Hanger for wrenches x1

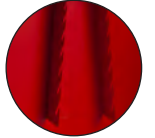

✓ Özel avadanlık x1
● Special tin holder x1

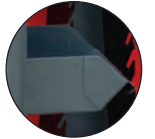

✓ Matkap ucu tutucu x1
● Drill bits holder x1



RAL 7016
RAL 3020

KOD/CODE	20 kg	Ölçü / SIZE (mm)	KG	COLORS	FİYAT TL/Ad.
8160 32 6001	3x	250x650x1010	35	RAL 7016 RAL 3020	1256,50

8160 32 6001

3x

250x650x1010

35

RAL 7016
RAL 3020

1256,50

Demonte Mini Servis Arabası
Disassembled Mini Service Trolley

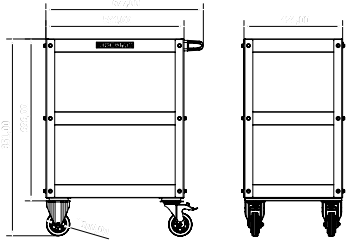

Çelik konstrüksiyon
Steel construction

- **3X Kauçuk Kaydırmaz Mat**
3X Rubber Anti Slipping Mats
- **2X Sabit, 2X Hareketli Frenli Tekerlek (ø 100 mm)**
2X Fixed, 2X Swivel Castors with Brake (ø 100 mm)
- **Sağlam sac metal yapı, Her raf 50 Kg taşır.**
Robust sheet-steel construction, Loading capacity per shelf 50 Kg

KOD/CODE	 420x590x57	Ölçü / SIZE (mm)	 KG	COLORS	FİYAT TL/Ad.
----------	---	------------------	---	--------	-----------------

8550 34 8001

3x

424x594x851

18

RAL 9005
RAL 3020

670,00

Demonte Mini Servis Arabası (kapalı)
Disassembled Mini Service Trolley (closed)

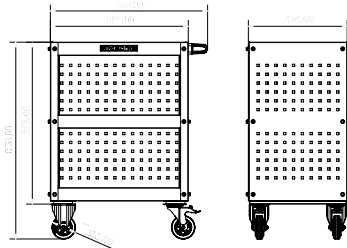

Çelik konstrüksiyon
Steel construction

- **3X Kauçuk Kaydırmaz Mat**
3X Rubber Anti Slipping Mats
- **2X Sabit, 2X Hareketli Frenli Tekerlek (ø 100 mm)**
2X Fixed, 2X Swivel Castors with Brake (ø 100 mm)
- **Sağlam sac metal yapı, Her raf 50 Kg taşır.**
Robust sheet-steel construction, Loading capacity per shelf 50 Kg
- **Arabanın yanları ve arkasında kare askı delikleri**
Square-shaped perforation on the side panels and back panel offers individual fastening

KOD/CODE	 420x590x57	Ölçü / SIZE (mm)	 KG	COLORS	FİYAT TL/Ad.
----------	---	------------------	---	--------	-----------------

8550 34 8002

3x

424x594x851

23

RAL 9005
RAL 3020

850,00

8545
1

Taşıma Arabası Platform Wagon

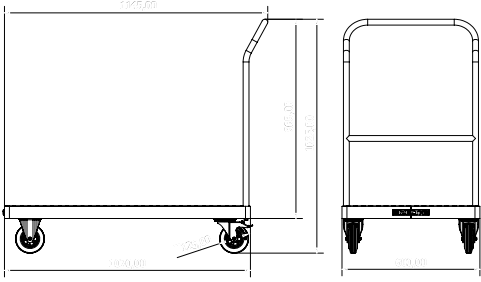

- **18mm Plywood Tabla (Kauçuk Mat ile Birlikte)**
18mm PLYWOOD table (with rubber mat)
- **2X Sabit, 2X Hareketli Frenli Tekerlek (ø 200mm)**
2X Fixed, 2X Swivel Castors with Brake (ø 200mm)
- **Sağlam sac metal yapı, Her raf 540 Kg taşır.**
Robust sheet-steel construction, Loading capacity per shelf 540 Kg

Çelik konstrüksiyon
Steel construction

KOD/CODE	Ölçü / SIZE (mm)	KG	COLORS	FİYAT TL/Ad.
----------	------------------	----	--------	--------------

8545 34 1005

600x1145x1025

38

RAL 9005

1624,05

8550

Servis Arabası (Büyük Boy) Service Trolley (Large Size)

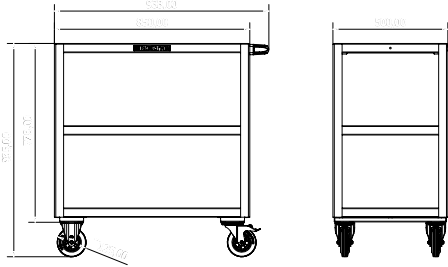

- **3X Kauçuk Kaydırmaz Mat**
3X Rubber Anti Slipping Mats
- **2X Sabit, 2X Hareketli Frenli Tekerlek (ø 125 mm)**
2X Fixed, 2X Swivel Castors with Brake (ø 125 mm)
- **Sağlam sac metal yapı, Her raf 75 Kg taşır.**
Robust sheet-steel construction, Loading capacity per shelf 75 Kg

Çelik konstrüksiyon
Steel construction

KOD/CODE	75 kg	Ölçü / SIZE (mm)	KG	COLORS	FİYAT TL/Ad.
----------	-------	------------------	----	--------	--------------



494x844x40

8550 34 6001

3x

500x850x935

37

RAL 3020

1152,05

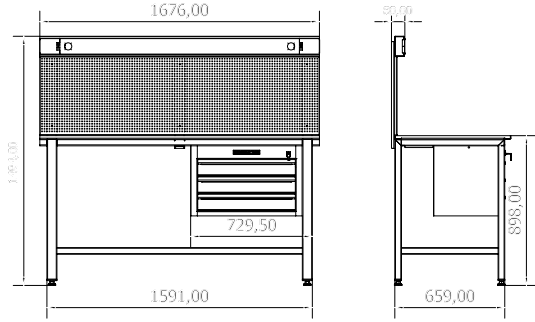
Servis Masası (Panolu)
Work Bench (With Panel)

- **Merkezi kilit sistemi, mandal sistemi**
Central locking system, handgrip lock system
- **Kaynaklı sağlam tasarım**
Robust welded design
- **%100 Açılabilir teleskobik raylar**
100% extendable telescopic slides
- **Yüksek dayanımlı elektrostatik toz boya.**
High strength electrostatic powder paint
- **Delikli panel (220 V prizler ile).**
Perforated panel with electrical plugs 220 V

Çelik Konstrüksiyon ve zor koşullarda çalışmaya elverişli
 Özel Plywood ahşap tezgah
 Strong and durable steel construction and Plywood bench

KOD/CODE		Ölçü / SIZE (mm)	KG	COLORS	FIYAT TL/Ad.
	348x548x90				

8500 34 6001

3x

720x1680x1495

102

 RAL 7016
 RAL 3020

3500,00

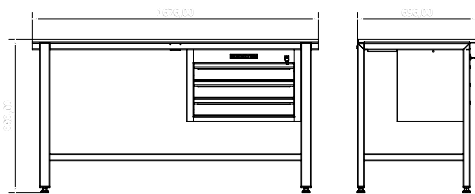
8501
Servis Masası (Panosuz)
Work Bench (Without Panel)

- **Merkezi kilit sistemi, mandal sistemi**
Central locking system, handgrip lock system
- **Kaynaklı sağlam tasarım**
Robust welded design
- **%100 Açılabilir teleskobik raylar**
100% extendable telescopic slides
- **Yüksek dayanımlı elektrostatik toz boya.**
High strength electrostatic powder paint

Çelik konstrüksiyon ve zor koşullarda çalışmaya elverişli
 Özel Plywood ahşap tezgah
 Strong and durable steel construction and Plywood bench

KOD/CODE		Ölçü / SIZE (mm)	KG	COLORS	FIYAT TL/Ad.
	348x548x90	696x1676x898			

8501 34 6001

3x

700x1680x900

84

 RAL 7016
 RAL 3020

2650,00

Demonte Servis Masası
Disassembled Work Bench

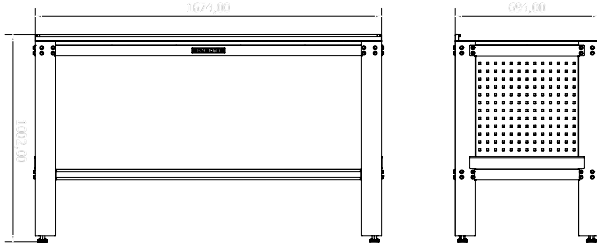

- **Demonte sağlam tasarım**
Robust disassembled design
- **18mm Plywood Tabla (Kauçuk mat ile birlikte)**
18mm Plywood Bench with non-slip rubber insert
- **Ayarlanabilir ayaklar**
Height adjustable feet
- **İZELTAS Eco ve/veya Trend Dolaplar ile kombine kullanabilme imkanı**
Can be combined with IZELTAS Eco and Trend Trolley

Çelik konstrüksiyon
Steel construction

KOD/CODE		Ölçü / SIZE (mm)	 KG	COLORS	FİYAT TL/Ad.
	200x500x55				

8502 34 6001

3x

694x1674x1002



35

RAL 3020

2300,00

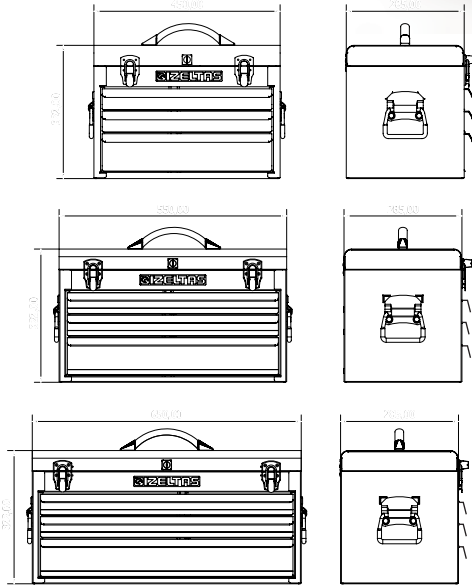
Çekmeceli Alet Sandığı
Tool Chest With Drawers

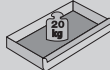
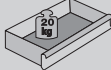

KOD/CODE	Ölçü / SIZE (mm)	ÇEKMECE DRAWERS				FİYAT TL/Ad
8320 33 1001	285x450x322	3x	2x	1x	16	1162,35
★8320 33 1002	285x550x322	3x	2x	1x	18	1174,70
8320 33 1003	285x650x322	3x	2x	1x	20	1187,05

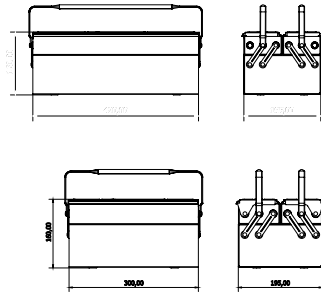
8420
Takım Çantası (3 Gözlü)
Tool Box (3 Trays)

Sacdan imal edilmiş, Fırın boya
 Made from metal sheet, Electrostatic paint

KOD CODE	Ölçü / SIZE (mm)	g	TL/Ad	FİYAT TL/Ad
8410 33 6103	190x300x150	2400	1	117,75
8410 33 6203	190x420x150	3000	1	147,20

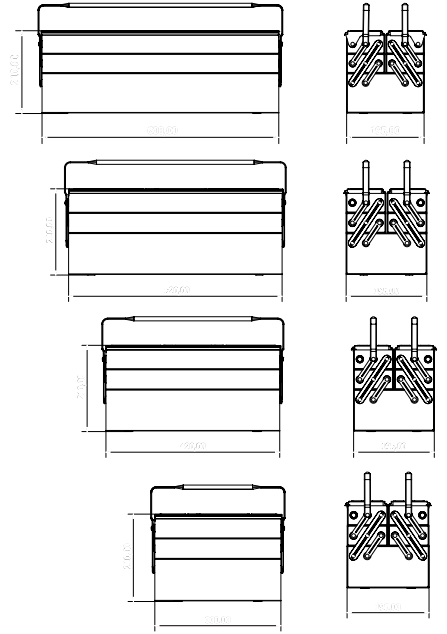
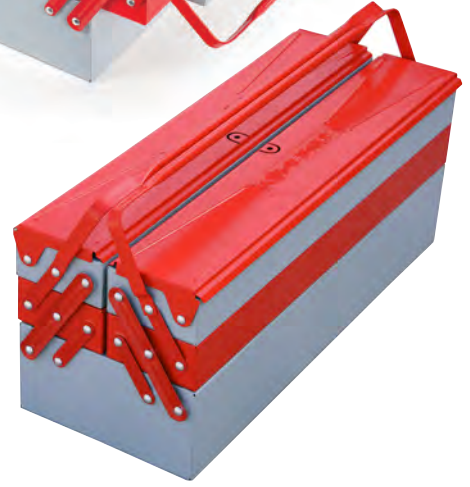
8420
Takım Çantası (5 Gözlü)
Tool Box (5 Trays)

Sacdan imal edilmiş, Fırın boya
 Made from metal sheet, Electrostatic paint

KOD CODE	Ölçü / SIZE (mm)	g	TL/Ad	FİYAT TL/Ad
8420 33 6105	195x300x210	3200	1	172,50
8420 33 6205	195x420x210	4200	1	179,10
8420 33 6305	195x520x210	5000	1	204,10
8420 33 6405	195x600x210	5600	1	275,00

(★) İşaretli olan ürünler stoklarla sınırlıdır.
 Limited with stocks.

1 Takım Çantası (5 Gözlü)
Tool Box (5 Trays)**8420 00 5063**

Mekanikçi Takım Çantası (62 Parça, 5 Gözlü)
Tool Box for Mechanician (62 Pcs, 5 Trays)

**8420 00 5046**

Elektrikçi Takım Çantası (45 Parça, 5 Gözlü)
Tool Box for Electrician (45 Pcs, 5 Trays)

**8420 00 5028**

Tesisatçı Takım Çantası (28 Parça, 5 Gözlü)
Tool Box for Plumbers (28 Pcs, 5 Trays)



8420 00 5063
Mekanikçi Takım Çantası (5 Gözlü)
Tool Box for Mechanician (5 Trays)

KOD CODE	ÖLÇÜ SIZE mm	TL/Ad.
8420 00 5063	195x420x210 DOLU / FULL	62 1540,10

KOD CODE	İÇERİK CONTENTS	
05881 50 015	5 m Krom Şerit Metre Chrom Case Steel, Measuring tapes	1
4785 19 6330	6.3x30 Kısa Bits Tutucu Tornavida Screwdriver, Magnetic Bit Holder (Short)	1
4800 00 8110	10 'Lu Bits Takım Bits Set 10 (Pcs) 25 mm	10
4320	Yıldız Uçlu Tornavida Opak Seri Screwdriver, Opak, Flat 4.5x80-6x100	2
4300	Düz Uçlu Tornavida Opak Seri Screwdriver, Opak, Philips 3x80-4x100-5x125-6x150	4
4550 17 0135	135mm Kontrol Kalemi Voltage Tester	1
2400 11 0240	240mm Üniversal Fort Pense Water Pump Pliers Universal	1
1113	1/2" Lokma Anahtar Socket Wrench 10-11-12-13-14-15-17-19-22-24-27-30-32 mm	13
1513 06 4250	1/2" Uzun Ara Kol Extension Bar Long 250 mm	1
1513 06 4070	1/2" Mafsals Universal Joint 70 mm	1
1513 06 0032	1/2" Cırcır Kol 32 Dişli Ratchet Handle 250 mm	1
4900 00 3112	12 'Li Allen Takım Hex Key Wrench Set	12
0320	Kısa Kombine Anahtar Combination Wrench Short Pattern 8-9-10-11-12-13-14-17-19-22 mm	10
3700 16 2160	160mm Opak İzole Yan Keski Side Cuting Nippers, Opak insulated	1
3020 12 2180	180mm Opak İzole Kombine Pense Combination Pliers, Opak Insulated	1
3220 13 2160	160mm Opak İzole Düz Kargaburun Nose Pliers, Flat, Opak Insulated	1

8420 00 5046
Elektrikçi Takım Çantası (5 Gözlü)
Tool Box for Electrician (5 Trays)

KOD CODE	ÖLÇÜ SIZE mm	TL/Ad.
8420 00 5046	195x420x210 DOLU / FULL	45 1662,05

KOD CODE	İÇERİK CONTENTS	
05881 50 005	5m Plastik Şerit Metre Plastic Measuring Tape	1
4783 19 6120	1000V İzoleli Manyetik Bits Tutucu Tornavida Screwdriver, Magnetic Bit Holder Insulated 6.3x120	1
4800 00 8106	6 'Li Bits Takım Bits Set (6 Pcs)	6
0600 01 1010	10" Kurbağcık Anahtar Adjustable Jaw Wrench, PVC Insulated	1
4140-4145	1000V İzoleli Elektrikçi Düz Yıldız Tornavida Insulated Electrician type Flat Screwdriver, Phillis 1000V 4x100-5.5x125 - 4.5x80-6x100	4
4550 17 0135	135mm Kontrol Kalemi Voltage Tester	1
4550 17 0190	190mm Kontrol Kalemi Voltage Tester	1
4773	1000V Süngüsü İzoleli Lokma Uçlu Tornavida Nut Spinner, Electrician Blode Insulated 1000V 6-7-8-10-13 mm	5
0340	Cırcır Kombine Anahtar Combination Wrench With Ratchet 8-10-12-13-17-19 mm	6
4900 00 3110	10 'Lu Allen Anahtar Takımı (mm) Hex Key Wrench Set 10 pcs	10
4500-4520	Klemens Tornavida Screwdriver, Electronic 3x80-3x100-3x125-3x60-4x80	5
3700 16 6160	1000V İzoleli Elektrikçi 160mm Yan Keski Insulated Electrician Type Side Cutter 1000V	1
3020 12 6180	1000V İzoleli Elektrikçi 180mm Kombine Pense Insulated Electrician Type Combination Plier 1000V	1
3220 13 6160	1000V İzoleli Elektrikçi 160mm Kargaburun Insulated Electrician Type Nose Plier 1000V	1

8420 00 5028
Tesisatçı Takım Çantası (5 Gözlü)
Tool Box for Plumbers (5 Trays)

KOD CODE	ÖLÇÜ SIZE mm	TL/Ad.
8420 00 5028	195x420x210 DOLU / FULL	28 1605,85

KOD CODE	İÇERİK CONTENTS	
0600 01 1010	10" Kurbağcık Anahtar 10" Adjustable Jaw Wrench, PVC Insulated	1
0600 01 1012	12" Kurbağcık Anahtar 12" Adjustable Jaw Wrench, PVC Insulated	1
2400 11 0240	240 Üniversal Fort Pense 240 Waterpump Pliers, Universal	1
2100 10 0012	12" Stilson Boru Anahtarı 12" Pipe Wrench, Stillson	1
4901 22 1270	1/2" Sae Allen Anahtar 1/2" Hex Key Wrench SAE	1
4300 17 6150	Düz Uçlu Tornavida Opak Seri Screwdriver, Opak, Slotted 6x150 mm	1
4320 18 6100	Yıldız Uçlu Tornavida Opak Seri Screwdriver, Opak, Phillips 6x100 mm	1
5800 25 0500	500gr Çekiç / Machinist Hammer	1
5500 23 0200	200mm Düz Keski / Flat Cold Chiesel	1
3830 15 0250	250mm Betoncu Kerpeten Tower Pincers	1
4900 00 3112	12 'Li Allen Anahtar Takımı (mm) Hex Key Wrench Set 12 pcs	12
0588 15 0015	5m Krom Şerit Metre Chrom Case Steel Measuring Tape	1
2201 10 0010	1" Maşalı Boru Anahtarı 1" Pipe Wrench	1
3700 16 2160	160mm Opak İzole Yan Keski Side Cutting Nippers, Opak insulated	1
3020 12 2180	180mm Opak İzole Kombine Pense Combination Pliers, Opak Insulated	1
3220 13 2160	160mm Opak İzole Düz Kargaburun Nose Pliers, Flat, Opak Insulated	1

1

8440

1

Plastik Takım Çantaları
Plastic Tool Boxes



KOD CODE	inch	ÖLÇÜ SIZE mm	g	TL/ Ad.
8440 33 1016	16"	413x212x186	1207	4 60,00
8440 33 1019	19"	480x267x242	1922	4 75,00
8440 33 1022	22"	564x310x310	2870	4 125,00

8445

Tekerlekli Plastik Takım Çantası
Plastic Mobile Tool Chest



KOD CODE	inch	ÖLÇÜ SIZE mm	g	TL/ Ad.
8445 33 1028	28"	380x595x420	5900	1 295,00

8705 00 6113

Hobby Set Oto Tipi (13 Parça)
Hobby Set Auto Type (13 pcs)



KOD CODE	İÇERİK CONTENTS	TL/ Ad.
0100	İki Ağız Anahtar (Kısa Boy) Duble Ended Open Jaw Wrench Short Pattern 8x9-10x11-12x13-14x15-16x17-18x19	6
1841	21 mm Kovan Anahtar Bir Ağız Single Ended Tubular Socket Wench	1
2400	240 mm Ünlversal Fort Pense Waterpump Pliers Universal	1
3020	160 mm Kombine Pense Opak Combination Pliers	1
4240	Değişken Uçlu Tornavida Takımı Screwdriver Set Reversible 4.5x80 - 6x80	1
5800	200 gr Tesviyeci Çekiç / Machinist Hammer	1
6350	300 mm Levye Oluklu / Tyre Lever Straight	1

8790 00 8106

Bakım Onarım Seti (5 Parça)
Maintenance Set (5 Pcs)



KOD CODE	İÇERİK CONTENTS	TL/ Ad.
3020 12 3160	160 mm Kombine Pense Kraft Combination Pliers	1
3220 13 3160	160 mm Kargaburun Düz Uçlu Kraft Nose Pliers Flat	1
3700 16 3140	140 mm Yan Keski Kraft Side Cutting Pliers	1
4100 17 5100	5x100 Kraft Seri Düz Uçlu Tornavida Screwdriver Kraft, Flat	1
4120 18 4580	4.5x80 Kraft Seri Yıldız Uçlu Tornavida Screwdriver Kraft, Phillips	1

(★) İşaretili olan ürünler stoklarla sınırlıdır.
Limited with stocks.

8786 00 1003

Doğada Set (3 Parça)
Outdoor Set (3 Pcs)

**YENİ
NEW**

8793 00 1014

Bakım Seti (14 Parça)
Maintenance Set (14 Pcs)

**YENİ
NEW**



1

KOD CODE	İÇERİK CONTENTS	☐	TL/ Ad.
6710 27 0230	Bağ Makası Lüks / Pruning Shears	1	
6735 27 0300	Dal Budama Testeresi / Pruning Saw	1	428,10
6410 25 0800	Nacak / Hatchet	1	

KOD CODE	İÇERİK CONTENTS	☐	TL/Ad.
0130	İki Ağız Anahtar (Uzun Boy) Double Ended Open Jaw Wrench Long Pattern 6x7-8x9-10x11-12x13-14x15-16x17-18x19-20x22	8	
3220	160 mm Kargaburun Düz Uçlu Ergonomik Long Nose Pliers Flat	1	
3700	140 mm Yan Keski Ergonomik Side Cutting Pliers	1	410,20
4350	Ergonomik Seri Düz Uçlu Tornavida 4x100-6x100 Screwdriver Ergonomic, Flat	2	
4370	Ergonomik Seri Yıldız Uçlu Tornavida 4.5x80-6x100 Screwdriver Ergonomic, Phillips	2	



**ŞABLON
BILLET****FİNAL ÜRÜN
FINAL PRODUCT**

IZELTAS®

ANAHTARLAR

WRENCHES

İki Ağız Anahtarlar
Open Jaw Wrenches

Kombine Anahtarlar
Combination Wrenches

Yıldız Anahtarlar
Ring Wrenches

Çakma Anahtarlar
Slugging Wrenches

Kurbağacık Anahtarlar
Adjustable Wrenches



İKİ AĞIZ ANAHTAR / DOUBLE ENDED OPEN JAW WRENCH

Nikel üzeri mat krom kaplama ile tutuş kolaylığı ve korozyon direncinde üst seviye koruma
High corrosion resistance with chrome over nickel plating

Yüksek mukavemetli alaşımlı sıcak dövme çeliği
High strength alloyed cold work tool steel

15°açılı açık ağız anahtar
15° angled open jaws

TSE standartlarına uygun üretim/markalama
Production/marketing acc to TSE standards

Güvenli kullanım ve rahat kavrama için yuvarlatılmış yüzeyler
Rounded surfaces for safe and comfortable use

Dayanımı artırmak için güçlendirilmiş boyun tasarımı
Reinforced neck design to improve endurance

En uygun temas yüzeyi için hassas işlenmiş ağızlar
Precise machined jaws for best contact

0100

İki Ağız Anahtar Kısa Boy (mm)

Double Ended Open Jaw Wrench Short Pattern (mm)



TS 81-6
DIN 895

2



Krom vanadyum, Krom kaplı
Chrom vanadium, Chrom plated

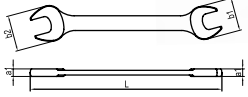

KOD CODE	mm	L mm	a1 mm	b1 mm	b2 mm	g	TL/Ad.	
0100 01 0405	4x5	97	3.5	11	12.5	15	10	9,70
0100 01 0607	6x7	97	3.5	14	16	18	10	9,90
0100 01 0809	8x9	108	4	18	20	30	10	10,15
0100 01 0810	8x10	117	4.6	18	22	33	10	10,40
0100 01 1011	10x11	120	4.6	22	24	41	10	11,10
0100 01 1012	10x12	120	4.6	22	26	35	10	11,10
0100 01 1013	10x13	120	4.6	22	28	38	10	11,90
0100 01 1114	11x14	133	5.2	26	28	50	10	12,20
0100 01 1213	12x13	133	5.2	26	28	57	10	12,20
0100 01 1214	12x14	147	5.2	26	30	59	10	12,20
0100 01 1314	13x14	147	5.2	28	30	66	10	12,20
0100 01 1415	14x15	147	5.8	30	32	78	10	14,15
0100 01 1317	13x17	162	6.2	28	36	80	10	16,10
0100 01 1417	14x17	162	6.2	30	36	90	10	16,50
0100 01 1617	16x17	162	6.2	34	36	109	10	16,50
0100 01 1719	17x19	178	7	36	40	143	10	17,70
0100 01 1819	18x19	178	7	38	40	144	10	17,70
0100 01 1820	18x20	178	7	38	40	125	10	20,00
0100 01 1822	18x22	195	7.4	38	46	160	10	20,00
0100 01 1922	19x22	195	7.4	40	46	175	10	20,00
0100 01 2022	20x22	195	7.4	42	46	196	10	20,00
0100 01 2123	21x23	213	7.7	44	48	230	10	20,90
0100 01 2224	22x24	213	8	46	50	239	10	21,85
0100 01 2426	24x26	232	8.2	50	54	297	10	22,50
0100 01 2427	24x27	232	8.2	50	56	296	10	22,50
0100 01 2528	25x28	248	8.6	52	57.5	366	10	27,95
0100 01 2732	27x32	265	9	56	66	415	10	33,30
0100 01 3032	30x32	265	9	62	66	465	10	33,30

ÖZEL SERİLER (adet ve termin süresi isteyiniz)

0100 01 0608	6x8	97	3.5	14	18	20	10	9,90
0100 01 0708	7x8	108	3.5	16	18	20	10	10,15
0100 01 0709	7x9	108	4	16	20	25	10	10,15
0100 01 0910	9x10	117	4.6	20	22	30	10	10,40
0100 01 0911	9x11	120	4.6	20	24	30	10	11,10
0100 01 1014	10x14	120	5.2	22	30	50	10	11,90
0100 01 1113	11x13	133	5.2	26	28	50	10	12,20
0100 01 1315	13x15	147	5.8	28	32	65	10	14,15
0100 01 1722	17x22	195	7.4	36	46	160	10	20,00
0100 01 1924	19x24	213	7.7	40	50	200	10	20,90
0100 01 2226	22x26	232	8	46	54	250	10	22,50
0100 01 2227	22x27	232	8.2	46	56	260	10	22,50
0100 01 2430	24x30	265	9	50	62	370	10	33,30
0100 01 2730	27x30	265	9	56	62	380	10	33,30

0100

İki Ağız Anahtar Takımı Kısa Boy (mm)

Double Ended Open Jaw Wrench
Short Pattern Set (mm)



KOD CODE	İÇERİK CONTENTS	g	TL/Ad.
0100 00 2108	6x7 - 8x9 - 10x11 12x13 - 14x15 - 16x17 18x19 - 20x22	736	8 111,70
0100 00 2112	6x7 - 8x9 - 10x11 12x13 - 14x15 - 16x17 18x19 - 20x22 - 21x23 24x26 - 25x28 - 30x32	2110	12 216,35

(★) İşaretli olan ürünler stoklarla sınırlıdır.
Limited with stocks.

İki Ağız Anahtar Uzun Boy (mm)

Double Ended Open Jaw Wrench Long Pattern (mm)

TS ISO 10102
DIN 3110

2

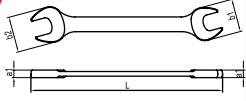

Krom vanadyum, Krom kaplı
Chrom vanadium, Chrom plated

KOD CODE	mm	L mm	a1 mm	b1 mm	b2 mm	g	TL/Ad.	
0130 01 0607	6x7	125	3.5	14	16	24	10	12,65
0130 01 0608	6x8	125	3.5	14	18	20	10	13,10
0130 01 0809	8x9	140	4	18	20	35	10	13,10
0130 01 0810	8x10	140	4	18	22	36	10	13,10
0130 01 1011	10x11	155	4.5	22	24	47	10	14,50
0130 01 1012	10x12	162	4.7	22	26	57	10	14,50
0130 01 1013	10x13	162	4.7	22	28	61	10	14,50
0130 01 1014	10x14	162	4.7	22	28	65	10	14,50
0130 01 1113	11x13	172	5	26	28	70	10	14,50
0130 01 1114	11x14	172	5	26	30	65	10	14,50
0130 01 1213	12x13	172	5	26	28	67	10	15,25
0130 01 1214	12x14	172	5	26	30	65	10	15,25
0130 01 1314	13x14	188	5.5	28	30	85	10	15,25
0130 01 1315	13x15	188	5.5	30	32	93	10	15,25
0130 01 1415	14x15	188	5.5	30	32	91	10	17,75
0130 01 1317	13x17	205	6.2	28	36	111	10	19,35
0130 01 1417	14x17	205	6.2	30	36	106	10	19,35
0130 01 1617	16x17	205	6.2	34	36	120	10	19,60
0130 01 1618	16x18	220	7	36	40	165	10	22,20
0130 01 1719	17x19	220	7	36	40	160	10	20,90
0130 01 1819	18x19	220	7	38	40	161	10	20,90
0130 01 1921	19x21	235	7.5	40	46	195	5	24,35
0130 01 1922	19x22	235	7.5	40	46	195	5	24,35
0130 01 2022	20x22	235	7.5	42	46	195	5	24,35
0130 01 1924	19x24	248	8.3	40	50	235	5	24,45
0130 01 2123	21x23	248	8.3	44	48	235	5	24,85
0130 01 2224	22x24	248	8.3	46	50	235	5	25,55
0130 01 2426	24x26	265	8.8	50	54	300	5	29,20
0130 01 2427	24x27	265	8.8	50	56	300	5	29,20
0130 01 2430	24x30	282	9.3	50	61.5	380	5	32,70
0130 01 2528	25x28	282	9.3	52	57.5	390	5	32,70
0130 01 2729	27x29	300	9.8	56	59	400	5	40,80
0130 01 2730	27x30	300	9.8	56	59	440	5	40,80
0130 01 2732	27x32	300	9.8	56	65.5	460	5	40,80
0130 01 3032	30x32	300	9.8	61.5	65.5	480	5	40,80
0130 01 3036	30x36	325	10.4	61.5	76	645	5	77,45
0130 01 3236	32x36	325	10.4	65.5	76	680	5	77,45
0130 01 3436	34x36	330	10.4	71	76	690	5	77,45
0130 01 3641	36x41	360	12	76	87	955	5	120,35
0130 01 4146	41x46	400	12.5	87	98	1300	5	185,55
0130 01 4650	46x50	450	13	98	107	1635	5	205,80

ÖZEL SERİLER (adet ve termin süresi isteyiniz)

SPECIAL SERIES (ask for quantity and delivery terms)

0130 01 0555	5x5.5	97	3.5	14	16	15	10	9,90
0130 01 0708	7x8	135	3.5	16	18	20	10	13,10
0130 01 0709	7x9	140	4	16	20	30	10	13,10
0130 01 0910	9x10	140	4.5	20	22	45	10	14,50
0130 01 0911	9x11	155	4.5	20	24	45	10	14,50
0130 01 1722	17x22	235	7.5	36	46	190	5	24,35
0130 01 1724	17x24	248	8.3	36	50	240	5	24,45
0130 01 2227	22x27	265	8.8	46	56	300	5	29,20

0130

İki Ağız Anahtar Takımı Uzun Boy (mm)

Double Ended Open Jaw Wrench
Long Pattern Set (mm)



KOD CODE	İÇERİK CONTENTS	g	TL/Ad.	
0130 00 2108	6x7 - 8x9 - 10x11 - 12x13 14x15 - 16x17 - 18x19 20x22	815	8	138,10
0130 00 2112	6x7 - 8x9 - 10x11 12x13 - 14x15 - 16x17 18x19 - 20x22 - 21x23 24x26 - 25x28 - 27x32	2315	12	265,65

(★) İşaretli olan ürünler stoklarla sınırlıdır.
Limited with stocks.

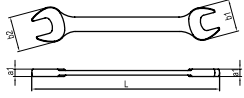
0161
İki Ağız Anahtar Uzun Boy (SAE)
Double Ended Open Jaw Wrench Long Pattern (SAE)

Krom vanadyum, Krom kaplı
Chrom vanadium, Chrom plated

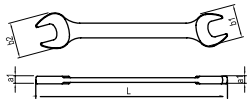
KOD CODE	inch	L mm	a1 mm	b1 mm	b2 mm	g	TL/ Ad.
0161 01 0608	1/4"x5/16"	125	3.5	14	16	20	10 15,70
0161 01 0809	5/16"x3/8"	140	4	18	20	30	10 15,70
0161 01 0810	5/16"x11/32"	140	4	18	20	30	10 15,70
0161 01 0811	5/16"x7/16"	140	4	18	22	30	10 15,70
0161 01 0911	3/8"x7/16"	155	4.5	22	24	35	10 17,40
0161 01 1112	7/16"x1/2"	172	5	26	28	40	10 17,40
0161 01 1214	1/2"x9/16"	172	5	26	30	65	10 18,35
0161 01 1416	9/16"x5/8"	188	5.5	30	32	85	10 21,35
0161 01 1417	9/16"x11/16"	205	6.2	30	36	110	10 23,25
0161 01 1517	19/32"x11/16"	205	6.2	34	36	115	10 23,50
0161 01 1619	5/8"x3/4"	220	7	36	40	150	10 25,10
0161 01 1920	3/4"x25/32"	220	7	38	40	160	10 25,10
0161 01 2021	25/32"x13/16"	235	7.5	40	46	195	10 29,20
0161 01 1922	3/4"x7/8"	235	7.5	40	46	195	10 29,20
0161 01 2122	13/16"x7/8"	248	8.3	44	48	235	10 29,75
0161 01 2325	15/16"x1"	265	8.8	50	54	300	10 35,10
0161 01 2328	15/16"x1 1/8"	265	8.8	50	56	300	10 35,50
0161 01 2628	1 1/16"x1 1/8"	300	9.8	56	59.5	460	10 51,00
0161 01 2631	1 1/16"x1 1/4"	300	9.8	56	65.5	460	10 53,85
0161 01 2833	1 1/8"x1 5/16"	300	9.8	56	65.5	460	10 53,85

0132
İki Ağız Anahtar Uzun Boy MASTER (mm)
Double Ended Open Jaw Wrench MASTER
Long Pattern (mm)
TS ISO 10102
DIN 3110

Saten krom yüzeyli, Krom vanadyum, Krom kaplı
Satin chrom finish, Chrom vanadium, Chrom plated

KOD CODE	mm	L mm	a1 mm	b1 mm	b2 mm	g	TL/ Ad.
★0132 01 1415	14x15	188	5.5	30	32	85	10 20,35
★0132 01 1819	18x19	220	7	38	40	160	10 24,00
★0132 01 2528	25x28	282	9.3	52	57.5	390	5 37,50
★0132 01 2732	27x32	300	9.8	56	65.5	460	5 46,75

0161
İki Ağız Anahtar Takımı Uzun Boy (SAE)
Double Ended Open Jaw Wrench
Long Pattern Set (SAE)

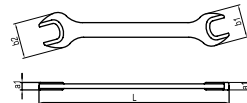
KOD CODE	İÇERİK CONTENTS	g	TL/ Ad.
0161 00 2108	1/4"x5/16" - 5/16"x3/8" 7/16"x1/2" - 9/16"x5/8"-19/32"x11/16" 3/4"x25/32" - 13/16"x7/8"-15/16"x1"	1090	8 183,60
0161 00 2112	1/4"x5/16" - 5/16"x3/8" - 3/8"x7/16" 7/16"x1/2" - 1/2"x9/16" - 9/16"x5/8" 19/32"x11/16" - 3/4"x25/32" - 13/16"x7/8" 15/16"x1" - 1 1/16"x1 1/4" 1 1/8"x1 5/16"	2165	12 327,05

0220
İki Ağız Taçlı Anahtar (mm)
Double Ended Open Jaw Wrench (mm)

Krom vanadyum, Krom kaplı
Chrom vanadium, Chrom plated

KOD CODE	mm	L mm	a1 mm	b1 mm	b2 mm	g	TL/ Ad.
★0220 01 1722	17x22	195	7.5	35.5	44.5	120	10 22,50

(★) İşaretili olan ürünler stoklarla sınırlıdır.
Limited with stocks.

0250

Bir Ağız Taçlı Anahtar (mm) Single Ended Open Jaw Wrench (mm)

2

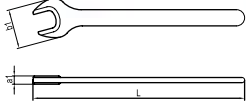

Krom vanadyum
Chrom vanadium

KOD CODE	mm	L mm	a1 mm	b1 mm	g	TL/Ad.
0250 01 0030	30	260	10.5	60.2	250	1 58,45
0250 01 0036	36	300	10.5	74.6	370	1 73,75
0250 01 0041	41	345	12.2	85.5	550	1 96,35
0250 01 0046	46	390	14	96.3	750	1 103,65
0250 01 0050	50	425	15.2	105	1000	1 129,45
0250 01 0055	55	455	16.5	113.5	1300	1 173,50
0250 01 0060	60	490	18.4	121	1600	1 222,15
0250 01 0065	65	524	19	130	1980	1 270,85

ÖZEL SERİLER (adet ve termin süresi isteyiniz) SPECIAL SERIES (ask for quantity and delivery terms)

0250 01 0021	21	185	8	42.4	95	10	-----
0250 01 0022	22	195	8	44.4	110	10	-----
0250 01 0023	23	195	8	46.3	115	10	-----
0250 01 0024	24	215	9	48.3	150	10	-----
0250 01 0025	25	215	9	50.3	155	10	-----
0250 01 0027	27	240	9.5	54.3	200	5	-----
0250 01 0032	32	270	10.5	64	300	5	-----
0250 01 0034	34	270	10.5	68	320	5	-----
0250 01 0038	38	300	10.5	76.8	400	5	-----
0250 01 0070	70	564	20.8	140	2480	1	-----
0250 01 0075	75	608	21.8	151	3100	1	-----

0255

Süper İzole Çatal Bir Ağız Anahtar (mm) Single Ended Open Jaw Wrench Super Insulated (mm)

IEC 60900
△ 1000 V



Krom vanadyum, Krom kaplı, Kalın PVC izoleli
Chrom vanadium, Chrom plated, Triple PVC insulated

KOD CODE	mm	L mm	g	TL/Ad.
0255 01 0010	10	110	40	10 34,15
0255 01 0011	11	120	45	10 36,05
0255 01 0012	12	130	50	10 37,65
0255 01 0013	13	140	60	10 40,55
0255 01 0014	14	155	75	10 42,10
0255 01 0017	17	170	100	10 51,65
0255 01 0019	19	185	150	10 60,70
0255 01 0022	22	200	200	10 81,60
0255 01 0024	24	220	280	10 99,85

0325

Montaj Anahtar (mm) Speed Wrench (mm)

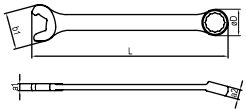

Krom vanadyum, Krom kaplı
Chrom vanadium, Chrom plated

KOD CODE	mm	L mm	a1 mm	a2 mm	b1 mm	ØD mm	g	TL/Ad.
0325 02 0010	10	130	4.3	6.9	22	15.5	35	10 21,85
0325 02 0013	13	160	5.2	7.9	28	19.5	45	10 24,45
0325 02 0017	17	200	6.4	9.8	36	25.5	110	10 32,40
0325 02 0019	19	220	7	11	40	28.5	155	10 37,90
0325 02 0020	20	235	7.2	11.4	42	30	180	10 38,65
0325 02 0021	21	245	7.4	12	44	31.5	180	10 44,95
0325 02 0022	22	255	8.2	12.6	46	33	245	10 51,45

70100 Daha Hızlı

Yeni tasarlanan montaj anahtarını, 2 kat hızlıncırcır mekanizması mantığına dayanan çalışma prensibinden alır. Kullanım sırasında, montaj anahtarını civatadan ayırmadan döndürme kolaylığı kullanım hızını artırırken, civata köşelerine sağlam tutunan anahtar profili güvenli ve kaydırmaz kullanım sağlar.

Uzun Ömür

Bu yeni montaj anahtarını profili, civata ve somunlar ile köşelerinden değil düz yüzeyleri üzerinden temas ederek düzenli tork iletimini sağlarken, gerilimin artmasını da engelleyerek anahtar ömrünün uzamasını sağlar.

• Anahtarını civatadan ayırmadan hızlı kullanılır.

• Güvenli tork iletimi ve uzun ömür.

100% Faster

The 100% new design speed wrench takes the 2-fold speed from the operating principle based on the ratchet mechanism logic. While in use, the ease of rotation without detaching the mounting wrench from the bolt increases the speed of use and the profile that firmly secured to the corners ensures safe and non-slip use

Long Life

This new mounting wrench profile by contacting bolts and nuts, not on corners, but on their flat surfaces, allows regular torx transmission, prevents the increase in surface tension and provides longer life.

• Quick use without detaching the wrench from the bolt.

• Safe torx transmission and long life.

0320

Kombine Anahtar Kısa Boy (mm) Combination Wrench Short Pattern (mm)



TS 3794
TS ISO 7738 Form A
DIN 3113

2

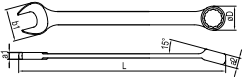

Krom vanadyum, Krom kaplı
Chrom vanadium, Chrom plated

KOD CODE	mm	L mm	a1 mm	a2 mm	b1 mm	øD mm	g	TL/Ad.	
0320 02 0005	5	100	3.4	5.1	14	10	15	10	12,65
0320 02 0055	5.5	100	3.4	5.1	14	10	15	10	12,65
0320 02 0006	6	100	3.4	5.1	14	10	15	10	13,10
0320 02 0007	7	110	3.6	5.5	16	11	20	10	13,95
0320 02 0008	8	120	3.8	5.9	18	13	25	10	15,15
0320 02 0009	9	130	4	6.3	20	14	30	10	15,55
0320 02 0010	10	140	4.3	6.9	22	15.5	40	10	17,55
0320 02 0011	11	150	4.5	7.3	24	17	45	10	17,95
0320 02 0012	12	160	4.9	7.7	26	18.5	55	10	19,20
0320 02 0013	13	170	5.2	7.9	28	19.5	60	10	19,60
0320 02 0014	14	180	5.5	8.7	30	21.5	75	10	21,20
0320 02 0015	15	190	5.8	9.1	32	22.5	90	10	22,70
0320 02 0016	16	200	6.1	9.6	34	24	105	10	24,35
0320 02 0017	17	210	6.4	9.8	36	25.5	120	10	25,95
0320 02 0018	18	220	6.8	10.4	38	27	145	10	29,00
0320 02 0019	19	232	7	11	40	28.5	170	10	30,50
0320 02 0020	20	240	7.2	11.4	42	30	195	10	31,05
0320 02 0021	21	250	7.4	12	44	31.5	190	10	36,05
0320 02 0022	22	260	8.2	12.6	46	33	275	10	41,20
0320 02 0023	23	270	8.3	13	48	35	255	5	41,20
0320 02 0024	24	280	8.5	13.6	50	36.5	320	5	50,40
0320 02 0025	25	290	8.8	14	52	39	320	5	50,40
0320 02 0026	26	300	9	14.8	54	41	400	5	59,35
0320 02 0027	27	310	9.3	15	56	41.5	400	5	59,35
0320 02 0028	28	320	9.4	15.4	57.5	42.5	380	5	59,35
0320 02 0029	29	330	10	15.6	59	43.5	510	5	68,00
0320 02 0030	30	340	10.3	16	61.5	44	505	5	68,00
0320 02 0032	32	370	10.5	16.2	65.5	47	560	5	71,50
0320 02 0034	34	400	10.7	16.8	71	50	675	5	74,75

0320

Kombine Anahtar Takımı Kısa Boy (mm) Combination Wrench Short Pattern Set (mm)



KOD CODE	İÇERİK CONTENTS	g	TL/Ad.
0320 00 2108	6 - 7 - 8 - 9 - 10 - 13 - 17 - 19	475	8 151,35
0320 00 2112	8 - 9 - 10 - 11 - 12 - 13 - 14 15 - 16 - 17 - 19 - 22	1190	12 270,90
0320 00 2117	6 - 7 - 8 - 9 - 10 - 11 - 12 - 13 - 14 15 - 16 - 17 - 18 - 19 - 20 - 21 - 22	1760	17 394,05
0320 00 2121	6 - 7 - 8 - 9 - 10 - 11 - 12 - 13 - 14 15 - 16 - 17 - 18 - 19 - 20 - 21 - 22 24 - 27 - 30 - 32	3650	21 643,30

Kombine Anahtar Uzun Boy (mm)
Combination Wrench, Long Pattern (mm)

 TS 3794
 TS ISO 7738 Form A
 DIN 3113

2

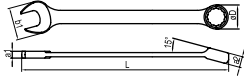
Krom vanadyum, Krom kaplı
Chrom vanadium, Chrom plated

KOD CODE	mm	L mm	a1 mm	a2 mm	b1 mm	øD mm	g	TL/Ad.	
0330 02 0005	5	95	3.2	5.2	12.5	9	20	10	14,60
0330 02 0055	5.5	100	3.4	5.4	13.5	9.5	20	10	14,60
0330 02 0006	6	105	3.8	5.6	14	10.5	20	10	14,60
0330 02 0007	7	117	4	6.1	16	12	20	10	14,60
0330 02 0008	8	130	4.2	6.6	18	13.5	30	10	17,10
0330 02 0009	9	141	4.5	7	20	15	40	10	17,30
0330 02 0010	10	154	4.7	7.6	22	16	50	10	19,20
0330 02 0011	11	166	5	8.2	24	17.5	60	10	20,25
0330 02 0012	12	178	5.2	8.7	26	19	70	10	20,25
0330 02 0013	13	190	5.6	9.2	28	20.5	80	10	22,75
0330 02 0014	14	203	5.8	9.7	30	22	100	10	23,60
0330 02 0015	15	215	6.4	10.1	32	23.5	115	10	25,25
0330 02 0016	16	227	6.4	10.8	34	25	135	10	25,55
0330 02 0017	17	239	6.6	11.4	36	26.5	160	10	29,00
0330 02 0018	18	250	7	12	38	28	186	10	31,30
0330 02 0019	19	263	7.3	12.7	40	29.5	205	10	34,00
0330 02 0020	20	275	7.7	13.2	42	31	235	10	36,15
0330 02 0021	21	288	8.1	13.3	44	31.5	260	10	38,45
0330 02 0022	22	300	8.5	13.7	46	34	300	10	45,80
0330 02 0023	23	315	8.8	14.2	48	35.5	300	5	55,95
0330 02 0024	24	330	9	14.2	50	37	390	5	55,95
0330 02 0025	25	340	9.3	14.7	52	38.5	380	5	55,95
0330 02 0026	26	350	9.7	14.7	54	40	475	5	65,90
0330 02 0027	27	360	10	15.2	56	41	475	5	65,90
0330 02 0028	28	370	10.4	15.7	57.5	43	475	5	65,90
0330 02 0029	29	390	10.8	16.2	59	44	610	5	65,90
0330 02 0030	30	410	11.2	16.6	61.5	45	610	5	75,70
0330 02 0032	32	420	11.5	17.1	65.5	48	755	5	79,35
0330 02 0034	34	430	11.8	17.4	71	51	735	5	80,90
0330 02 0036	36	440	12.2	17.7	76	53	1000	5	91,65
0330 02 0038	38	450	12.5	18.7	80	56	1000	5	93,80
0330 02 0041	41	480	13.5	19.7	87	61	1240	5	106,75
0330 02 0046	46	505	14.7	20.7	95	67.5	1635	1	145,05
0330 02 0050	50	540	15.9	22.7	104	73.5	2100	1	196,75

0330
Kombine Anahtar Takımı Uzun Boy (mm)
Combination Wrench Long Pattern Set (mm)

KOD CODE	İÇERİK CONTENTS	g	TL/Ad.	
0330 00 2108	6 - 7 - 8 - 9 - 10 - 13 17 - 19	665	8	168,55
0330 00 2112	8 - 9 - 10 - 11 - 12 13 - 14 - 15 - 16 17 - 19 - 22	1780	12	300,05
0330 00 2117	6 - 7 - 8 - 9 - 10 11 - 12 - 13 - 14 - 15 16 - 17 - 18 - 19 20 - 21 - 22	2170	17	435,15
0330 00 2121	6 - 7 - 8 - 9 - 10 - 11 12 - 13 - 14 - 15 - 16 17 - 18 - 19 - 20 - 21 22 - 24 - 27 - 30 - 32	4465	21	712,05

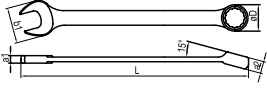
0331
Kombine Anahtar Uzun Boy (SAE)
Combination Wrench Long Pattern (SAE)
TSEK

Krom vanadyum, Krom kaplı
Chrom vanadium, Chrom plated

KOD CODE	inch	L mm	a1 mm	a2 mm	b1 mm	σD mm	g	TL/Ad.
0331 02 0005	3/16"	95	3.2	5.2	12.5	9	15	10 17,55
0331 02 0006	1/4"	105	3.8	5.6	14	10.5	20	10 18,25
0331 02 0008	5/16"	130	4.2	6.6	18	13.5	30	10 21,25
0331 02 0010	3/8"	154	4.7	7.6	22	16	50	10 24,25
0331 02 0011	7/16"	166	5	8.2	24	17.5	60	10 25,45
0331 02 0013	1/2"	190	5.6	9.2	28	20.5	80	10 28,70
0331 02 0014	9/16"	203	5.8	9.7	30	22	100	10 30,20
0331 02 0015	19/32"	215	6.4	10.1	32	23.5	115	10 32,00
0331 02 0016	5/8"	227	6.4	10.8	34	25	135	10 34,35
0331 02 0017	11/16"	239	6.6	11.4	36	26.5	155	10 36,60
0331 02 0019	3/4"	263	7.3	12.7	40	29.5	205	10 42,70
0331 02 0020	25/32"	275	7.7	13.2	42	31	230	10 45,70
0331 02 0021	13/16"	288	8.1	13.3	44	31.5	260	5 50,45
0331 02 0022	7/8"	300	8.5	13.7	46	34	310	5 58,10
0331 02 0024	15/16"	330	9	14.2	50	37	380	5 71,10
0331 02 0025	1"	340	9.3	14.7	52	38.5	380	5 71,10
0331 02 0027	1 1/16"	360	10	15.2	56	41	470	5 83,25
0331 02 0028	1 1/8"	370	10.4	15.7	57.5	43	470	5 83,25
0331 02 0030	1 3/16"	410	11.2	16.6	61.5	45	635	5 95,35
0331 02 0032	1 1/4"	420	11.5	17.1	65.5	48	775	5 99,95
0331 02 0033	1 5/16"	430	11.8	17.4	71	51	775	5 99,95
0331 02 0038	1 1/2"	450	12.5	18.7	80	56	1015	5 120,80

ÖZEL SERİLER (adet ve termin süresi isteyiniz)
SPECIAL SERIES (ask for quantity and delivery terms)

0331 02 0035	1 3/8"	440	12.2	17.7	76	53	1015	5 109,85
0331 02 0036	1 7/16"	440	12.2	17.7	76	53	1015	5 109,85
0331 02 0041	1 5/8"	480	13.5	19.7	87	61	1325	5 128,05
0331 02 0046	1 13/16"	505	14.7	20.7	95	67.5	1750	5 174,10
0331 02 0050	2"	540	15.9	22.7	104	73.5	2200	5 236,05

0331
Kombine Anahtar Takımı Uzun Boy (SAE)
Combination Wrench Long Pattern Set (SAE)
TSEK

KOD CODE	İÇERİK CONTENTS	g	TL/Ad.
0331 00 2108	5/16" - 3/8" - 7/16" - 1/2" - 9/16" - 5/8" - 11/16" - 3/4"	925	8 243,50
0331 00 2112	5/16" - 3/8" - 7/16" - 1/2" - 9/16" - 5/8" - 11/16" - 3/4" - 13/16" - 7/8" - 15/16" - 1"	2320	12 494,25
0331 00 2117	1/4" - 5/16" - 3/8" - 7/16" - 1/2" - 9/16" - 19/32" - 5/8" - 11/16" - 3/4" - 25/32" - 13/16" - 7/8" - 15/16" - 1" - 1 1/16" - 1 3/16"	3875	17 768,80
0331 00 2120	1/4" - 5/16" - 3/8" - 7/16" - 1/2" - 9/16" - 19/32" - 5/8" - 11/16" - 3/4" - 25/32" - 13/16" - 7/8" - 15/16" - 1" - 1 1/16" - 1 1/8" - 1 3/16" - 1 1/4" - 1 5/16"	5880	20 1051,95

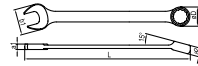
0322
Kombine Anahtar Kısa Boy MASTER (mm)
Combination Wrench MASTER
Short Pattern (mm)
TSE
TS 3794
TS ISO 7738 Form A
DIN 3113

Saten krom yüzeyli, Krom vanadyum, Krom kaplı
Satin chrom finish, Chrom vanadium, Chrom plated

KOD CODE	mm	L mm	a1 mm	a2 mm	b1 mm	σD mm	g	TL/Ad.
★0322 02 0006	6	100	3.4	5.1	14	10	15	10 13,75
★0322 02 0007	7	110	3.6	5.5	16	11	20	10 14,65
★0322 02 0008	8	120	3.8	5.9	18	13	25	10 15,85
★0322 02 0009	9	130	4	6.3	20	14	30	10 16,35
★0322 02 0011	11	150	4.5	7.3	24	17	45	10 18,95
★0322 02 0012	12	160	4.9	7.7	26	18.5	55	10 20,20
★0322 02 0014	14	180	5.5	8.7	30	21.5	75	10 22,35
★0322 02 0015	15	190	5.8	9.1	32	22.5	90	10 23,90
★0322 02 0016	16	200	6.1	9.6	34	24	105	10 25,60
★0322 02 0017	17	210	6.4	9.8	36	25.5	120	10 27,40
★0322 02 0018	18	220	6.8	10.4	38	27	145	10 30,50
★0322 02 0019	19	232	7	11	40	28.5	170	10 32,05
★0322 02 0020	20	240	7.2	11.4	42	30	195	10 32,60
★0322 02 0021	21	250	7.4	12	44	31.5	190	10 38,00
★0322 02 0022	22	260	8.2	12.6	46	33	275	10 43,50
★0322 02 0024	24	280	8.5	13.6	50	36.5	320	5 47,80
★0322 02 0025	25	290	8.8	14	52	39	340	5 52,55
★0322 02 0026	26	300	9	14.8	54	41	400	5 57,80
★0322 02 0030	30	340	10.3	16	61.5	44	505	5 69,35

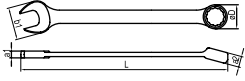
(★) İşaretili olan ürünler stoklarla sınırlıdır.
Limited with stocks.

Çırcır Kombine Anahtar (mm)
Combination Wrench With Ratchet (mm)
2

Krom vanadyum, Krom kaplı
 Chrom vanadium, Chrom plated

KOD CODE	mm	L mm	a1 mm	a2 mm	b1 mm	øD mm	g	TL/Ad.
0340 02 0008	8	136	5.1	7	18	17.5	35	10
0340 02 0009	9	143	5.4	7.6	20	19.3	40	10
0340 02 0010	10	160	5.8	7.7	22	21	55	10
0340 02 0011	11	168	6.1	8.3	24.5	22.7	70	10
0340 02 0012	12	174	6.4	8.7	26.5	24.7	80	10
0340 02 0013	13	180	6.7	9.3	27.6	26	90	10
0340 02 0014	14	193	7.4	9.4	31.4	27.7	120	10
0340 02 0015	15	200	7.7	10	33.4	29	135	10
0340 02 0016	16	216	8.1	10.6	34.6	30.7	155	10
0340 02 0017	17	233	8.8	10.9	38.4	33	190	10
0340 02 0018	18	239	9	11.2	39.9	33.7	200	10
0340 02 0019	19	250	9.5	11.5	41.5	34.8	240	10
0340 02 0021	21	285	10.2	13	45.8	42	350	10
0340 02 0022	22	285	10.2	13	45.8	42	340	10
0340 02 0024	24	325	11	14.5	51.5	47.5	470	5

0340
Çırcır Kombine Anahtar Takımı (mm)
Combination Wrench With Ratchet, Set (mm)

0335
Çoklu Yıldız Çırcır Anahtar (mm)
Multi-Ring Wrench (mm)

Krom vanadyum, Krom kaplı
 Chrom vanadium, Chrom plated

KOD CODE	ÖLÇÜ SIZE	g	TL/Ad.
0335 02 0010	10x13x17x19	215	5 195,50

KOD CODE	İÇERİK CONTENTS	g	TL/Ad.
0340 00 2110	8 - 9 - 10 - 11 12 - 13 - 14 - 15 17 - 19	1315	10 630,15
0340 00 2115	8 - 9 - 10 - 11 - 12 - 13 14 - 15 - 16 - 17 - 18 19 - 21 - 22 - 24	2445	15 1228,90

0345

Mafsallı Cırcır Kombine Anahtar (mm) Flexible Head Combination Wrench With Ratchet (mm)



2

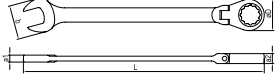

Krom vanadyum, Krom kaplı
Chrom vanadium, Chrom plated

KOD CODE	mm	L mm	a1 mm	a2 mm	b mm	σD mm	g	TL/Ad.	
0345 02 0008	8	136	5.5	7	17.1	17.5	40	10	80,70
0345 02 0009	9	136	5.5	7	17.1	17.5	50	10	82,25
0345 02 0010	10	140	6.1	7,7	21.3	21	60	10	85,60
0345 02 0011	11	142	6.4	8.3	23.7	22.7	80	10	88,25
0345 02 0012	12	143	6.7	8.7	25.8	24	90	10	93,30
0345 02 0013	13	156	7	9.3	26.8	26	105	10	97,30
0345 02 0014	14	164	7.3	9.4	30.4	27.7	125	10	102,35
0345 02 0015	15	174	7.7	10	31.1	29.1	145	10	107,40
0345 02 0016	16	176	8	10.6	33.8	30.7	185	10	116,85
0345 02 0017	17	195	8.3	10.9	37	32.6	210	10	118,40
0345 02 0018	18	213	8.6	11.2	38.7	33.7	235	10	127,50
0345 02 0019	19	214	9	11.3	40.2	34.8	260	10	133,20

0360

XL Ekstra Uzun Kombine Anahtar (mm) Extra Long (XL) Combination Wrench (mm)



0345

Mafsallı Cırcır Kombine Anahtar Takımı (mm) Flexible Head Combination Wrench With Ratchet, Set (mm)

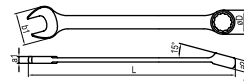

Krom vanadyum, Krom kaplı
Chrom vanadium, Chrom plated

KOD CODE	İÇERİK CONTENTS	g	TL/Ad.
0345 00 2112	8 - 9 - 10 - 11 - 12 - 13 14 - 15 - 16 - 17 - 18 - 19	1365	12

KOD CODE	mm	L mm	a1 mm	a2 mm	b1 mm	σD mm	g	TL/Ad.	
★0360 02 0008	8	170	4.5	7.5	20.3	13.2	45	10	18,70
★0360 02 0009	9	180	4.5	8	22.4	14.6	55	10	18,95
★0360 02 0010	10	190	5	8.5	24.4	16	60	10	21,10
★0360 02 0011	11	200	5.5	9	26.4	17.2	75	10	22,20
★0360 02 0012	12	210	6	9.5	28.4	19	90	10	22,20
★0360 02 0014	14	235	7	11	32.5	21.8	120	10	26,00
★0360 02 0015	15	250	7.5	12	34.5	23	150	10	27,70
★0360 02 0016	16	265	8	13	36.4	24.5	175	10	28,15
★0360 02 0018	18	295	9	15	40.6	28	240	10	34,50
★0360 02 0020	20	310	9.5	16	44.5	31	265	10	39,90
★0360 02 0030	30	480	14	21	64.8	47	870	1	83,25
★0360 02 0032	32	500	15	22	67	49.5	1000	1	99,25
★0360 02 0034	34	520	15	23	70	53	1100	1	101,25
★0360 02 0041	41	600	16	26	86	63.5	1700	1	160,35
★0360 02 0046	46	640	17.4	27	96	70.9	2230	1	186,85

(★) İşaretili olan ürünler stoklarla sınırlıdır.
Limited with stocks.

Boyunlu Kombine Anahtar (mm)
Offset Combination Wrench (mm)

 TS 3794
 TS ISO 7738 Form B
 DIN 3113

2

 Krom vanadyum, Krom kaplı
 Chrom vanadium, Chrom plated

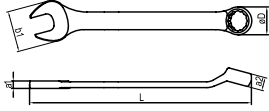
0370
Boyunlu Kombine Anahtar Takımı (mm)
Offset Combination Wrench, Set (mm)

KOD CODE	mm	L mm	a1 mm	a2 mm	b1 mm	ØD mm	g	TL/Ad.	
0370 02 0006	6	110	3.8	5.6	16	10.4	20	10	15,05
0370 02 0007	7	120	4	6.2	18	11.8	25	10	16,05
0370 02 0008	8	130	4.2	6.7	20	13.2	30	10	17,40
0370 02 0009	9	140	4.4	7.3	22	14.6	35	10	17,85
0370 02 0010	10	150	4.6	7.8	24	16	40	10	20,15
0370 02 0011	11	160	4.8	8.4	26	17.2	50	10	20,75
0370 02 0012	12	167	5	9	28	18.7	65	10	22,25
0370 02 0013	13	175	5.4	9.6	30	20	75	10	22,85
0370 02 0014	14	185	5.8	10.2	32	21.7	90	10	24,45
0370 02 0015	15	195	6.2	10.8	34	23	105	10	26,05
0370 02 0016	16	210	6.6	11.4	36	24.5	120	10	28,00
0370 02 0017	17	225	7	12	38	26	160	10	29,90
0370 02 0018	18	237	7.4	12.4	40	27.5	170	10	33,35
0370 02 0019	19	250	7.8	13	42	29	200	10	35,10
0370 02 0020	20	267	8.2	13.2	44	30.5	230	10	36,85
0370 02 0021	21	283	8.6	13.8	46	32	265	10	41,45
0370 02 0022	22	295	9	14.6	48	35	300	10	47,50
0370 02 0023	23	295	9	14.6	48	35	300	5	58,00
0370 02 0024	24	329	9.4	15.4	52	38	380	5	58,00
0370 02 0025	25	329	9.4	15.4	52	38	380	5	58,00
0370 02 0026	26	360	10.2	16.8	58	41.5	485	5	68,30
0370 02 0027	27	360	10.2	16.8	58	41.5	475	5	68,30
0370 02 0028	28	360	10.2	16.8	58	41.5	470	5	68,30
0370 02 0029	29	394	11	18.2	64	44.5	610	5	76,10
0370 02 0030	30	394	11	18.2	64	44.5	620	5	78,45
0370 02 0032	32	435	11.8	19.7	66	47.5	765	5	82,30
0370 02 0036	36	468	12.6	21.2	76	53	1020	5	95,10

KOD CODE	İÇERİK CONTENTS	g	TL/Ad.	
0370 00 2108	6 - 7 - 8 - 9 - 10 - 13 - 17 - 19	665	8	174,35
0370 00 2112	8 - 9 - 10 - 11 - 12 - 13 - 14 15 - 16 - 17 - 19 - 22	1375	12	312,25
0370 00 2117	6 - 7 - 8 - 9 - 10 - 11 - 12 - 13 - 14 15 - 16 - 17 - 18 - 19 - 20 - 21 - 22	2100	17	455,00
0370 00 2121	6 - 7 - 8 - 9 - 10 - 11 - 12 - 13 - 14 - 15 16 - 17 - 18 - 19 - 20 - 21 - 22 - 24 - 27 30 - 32	4425	21	742,05

0380

Torx® - mm Kombine Anahtar
Torx®- mm Combination Wrench

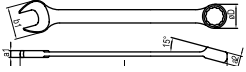
2

Krom vanadyum, Krom kaplı
Chrom vanadium, Chrom plated

KOD CODE	mm	*	L mm	a1 mm	a2 mm	b1 mm	ØD mm	g	□	TL/ Ad.
0380 02 0008	8	E10	170	4.5	7.5	20.3	13.2	45	10	30,40
0380 02 0009	9	E12	180	4.5	8	22.4	14.6	45	10	30,85
0380 02 0010	10	E14	190	5	8.5	24.4	16	60	10	34,25
0380 02 0011	11	E14	200	5.5	9	26.4	17.2	75	10	36,10
0380 02 0012	12	E16	210	6	9.5	28.4	19	90	10	37,10
0380 02 0013	13	E18	225	6.5	10	30.5	20	110	10	40,70
0380 02 0014	14	E18	235	7	11	32.5	21.8	120	10	45,00
0380 02 0015	15	E20	250	7.5	12	34.5	23	150	10	47,65
0380 02 0017	17	E22	280	8.5	14	38.4	26.5	210	10	51,75
0380 02 0018	18	E24	295	9	15	40.6	28	240	10	56,15
0380 02 0019	19	E24	310	9.5	16	42.6	29.5	280	10	60,80
0380 02 0022	22	E26	350	11	18	48.7	34.5	410	10	81,80

0380

Torx® - mm Kombine Anahtar Takımı
Torx®- mm Combination Wrench Set



Torx® -mm Kombine Anahtar: Bir çatal ağız ve bir yıldız ağızdan oluşan anahtarlarımız 8-22 mm arasında boyları bulunmaktadır. Çatal ağız kısmı mevcut çatal anahtarlardan farklı olarak 6 köşe avatanın yanısıra farklı geometri lere sahip avataları açabilmekte ve sıkabilmektedir.

TORX-mm combination wrench: Our wrenches consisting of an open end and a ring end are available in sizes from 8 to 22 mm. Unlike the existing open end wrenches, its open end can unbolt and tighten bolts with different geometries as well as the

KOD CODE	İÇERİK CONTENTS	g	□	TL/ Ad.
	8 - 9 - 10 - 11 - 12 - 13 - 17 - 19			
0380 00 2108	E10 - E12 - E14 - E14 E16 - E18 - E22 - E24	790	8	321,95
	8 - 9 - 10 - 11 - 12 - 13 14 - 15 - 17 - 18 - 19 - 22			
0380 00 2112	E10 - E12 - E14 - E14 - E16 - E18 E18 - E20 - E22 - E24 - E24 - E26	1590	12	552,55

(★) İşaretili olan ürünler stoklarla sınırlıdır.
Limited with stocks.

Yıldız İki Ağız Anahtar (mm) Double Ended Ring Wrench (mm)



TS 3794
TS ISO 10104 Form B
DIN 838

2

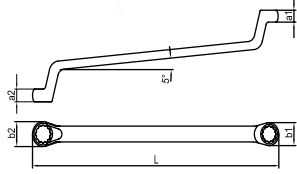

Krom vanadyum, Krom kaplı
Chrom vanadium, Chrom plated

KOD CODE	mm	L mm	a1 mm	a2 mm	b1 mm	b2 mm	g	TL/Ad.	
0430 03 0607	6x7	176	5.6	6	10	11.5	55	10	22,75
0430 03 0809	8x9	190	6.4	6.8	13	14.5	75	10	23,05
0430 03 0810	8x10	190	6.4	7.3	13	15.5	70	10	23,05
0430 03 1011	10x11	206	7.3	7.6	15.5	17	105	10	25,55
0430 03 1012	10x12	206	7.3	8.5	15.5	18.5	105	10	25,55
0430 03 1013	10x13	220	7.3	9	15.5	20	120	10	29,00
0430 03 1113	11x13	220	7.6	9	17	20	130	10	29,00
0430 03 1213	12x13	220	8.5	9	18.5	20	135	10	29,00
0430 03 1214	12x14	220	8.5	9.5	18.5	21.5	145	10	29,00
0430 03 1415	14x15	236	9.5	10	21.5	23	180	10	30,50
0430 03 1317	13x17	250	9	11.5	20	26.5	215	10	34,55
0430 03 1417	14x17	250	9.5	11.5	21.5	26.5	210	10	34,55
0430 03 1617	16x17	250	10.8	11.5	25	26.5	220	10	34,55
0430 03 1618	16x18	250	10.8	12	25	27.5	210	10	41,05
0430 03 1719	17x19	271	11.5	12.5	26.5	29	270	10	41,05
0430 03 1819	18x19	271	12	12.5	27.5	29	270	10	41,05
0430 03 1922	19x22	291	12.5	13.5	29	33	330	5	45,05
0430 03 1924	19x24	311	12.5	14.2	29	36.5	345	5	45,05
0430 03 2022	20x22	291	12.9	13.5	30.5	33	330	5	45,05
0430 03 2123	21x23	311	13.1	14	32	35	410	5	51,65
0430 03 2224	22x24	321	13.5	14.2	33	36.5	410	5	51,65
0430 03 2426	24x26	331	14.2	14.6	36.5	39.5	495	5	60,20
0430 03 2427	24x27	331	14.2	15	36.5	40.5	495	5	60,20
0430 03 2430	24x30	352	14.2	16.7	36.5	40	530	5	65,90
0430 03 2528	25x28	352	14.5	15.5	38	42.5	550	5	65,90
0430 03 2729	27x29	371	15	16.7	40.5	45	660	5	72,50
0430 03 2730	27x30	371	15	16.7	40.5	45	660	5	72,50
0430 03 2732	27x32	371	15	16.7	40.5	47.5	660	5	72,50
0430 03 3032	30x32	371	16.4	16.7	45	47.5	660	5	72,50
0430 03 3036	30x36	402	16.4	17.5	45	53	880	5	111,85
0430 03 3236	32x36	402	16.7	17.5	47.5	53	890	5	111,85
0430 03 3436	34x36	420	17.1	17.5	50	53	1000	5	136,70
0430 03 3641	36x41	438	17.5	19.5	53	61	1150	5	151,95
0430 03 4146	41x46	485	19.5	20.5	61	67.5	1430	5	208,20
0430 03 4650	46x50	535	20.5	22.4	67.5	73.5	1960	5	331,30

ÖZEL SERİLER (adet ve termin süresi isteyiniz) SPECIAL SERIES (ask for quantity and delivery terms)

0430 03 1014	10x14	220	7.3	9.5	15.5	21.5	120	10	29,00
0430 03 1315	13x15	236	9	10	20	23	170	10	30,50
0430 03 2227	22x27	331	14.2	15	36.5	40.5	500	5	60,20
0430 03 3034	30x34	379	16.4	16.9	45	50	690	5	96,40

0430

Yıldız İki Ağız Anahtar Takımı (mm) Double Ended Ring Wrench Set (mm)



KOD CODE	İÇERİK CONTENTS	g	TL/Ad.
0430 00 2108	6x7 - 8x9 - 10x11 - 12x13 - 14x15 16x17 - 18x19 - 20x22	1450	8 251,50
0430 00 2112	6x7 - 8x9 - 10x11 - 12x13 - 14x15 16x17 - 18x19 - 20x22 - 21x23 24x26 - 25x28 - 27x32	3610	12 501,75

0431

Yıldız İki Ağız Anahtar (SAE) Double Ended Ring Wrench (SAE)

TSEK



2

KOD CODE	inch	L mm	a1 mm	a2 mm	b1 mm	b2 mm	g	TL/Ad.
0431 03 0608	1/4"x5/16"	176	5.6	6	10	11.5	55	10 28,10
0431 03 0809	5/16"x3/8"	190	6.4	6.8	13	14.5	75	10 29,20
0431 03 0811	5/16"x7/16"	190	6.4	7.3	13	15.5	115	10 30,60
0431 03 0911	3/8"x7/16"	206	7.3	7.6	15.5	17	115	10 32,15
0431 03 1112	7/16"x1/2"	220	8.5	9	18.5	20	135	10 34,75
0431 03 1214	1/2"x9/16"	220	8.5	9.5	18.5	21.5	145	10 36,60
0431 03 1415	9/16"x19/32"	236	9.5	10	21.5	23	165	10 36,60
0431 03 1416	9/16"x5/8"	236	9.5	10	21.5	23	165	10 36,95
0431 03 1517	19/32"x11/16"	250	10.8	11.5	25	26.5	210	10 41,45
0431 03 1920	3/4"x25/32"	271	12	12.5	27.5	29	270	10 51,45
0431 03 2122	13/16"x7/8"	311	13.1	14	32	35	400	5 61,95
0431 03 2325	15/16"x1"	331	14.2	14.6	36.5	39.5	495	5 72,20
0431 03 2631	1 1/16"x1 1/4"	371	15	16.7	40.5	48	640	5 87,05
0431 03 2833	1 1/8"x1 5/16"	371	15	16.7	40.5	48	660	5 87,05
0431 03 3033	1 3/16"x1 5/16"	371	16.4	16.7	45	48	670	5 92,85

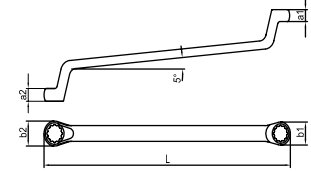

Saten krom yüzeyli, Krom vanadyum, Krom kaplı
Satin chrom finish, Chrom vanadium, Chrom plated

0431

Yıldız İki Ağız Anahtar Takımı (SAE) Double Ended Ring Wrench, Set (SAE)

TSEK

ÖZEL SERİLER (adet ve termin süresi isteyiniz) SPECIAL SERIES (ask for quantity and delivery terms)

0431 03 1217	1/2"x11/16"	250	9	10	20	26.5	185	10 41,45
0431 03 1417	9/16"x11/16"	250	9.5	11.5	21.5	26.5	185	10 41,45
0431 03 1617	5/8"x11/16"	250	10.8	11.5	25	26.5	210	10 41,45
0431 03 1619	5/8"x3/4"	271	11.5	12.5	26.5	29	270	10 49,40
0431 03 2021	25/32"x13/16"	291	12.9	13.5	30.5	33	270	5 54,05
0431 03 1922	3/4"x7/8"	291	12.9	13.5	30.5	33	400	5 54,05
0431 03 2223	7/8"x15/16"	321	13.5	14.2	33	36.5	400	5 61,95
0431 03 2328	15/16"x1 1/8"	331	14.2	15	36.5	40.5	500	5 72,20
0431 03 2528	1"x1 1/8"	352	14.5	15.5	38	42.5	570	5 79,05
0431 03 3036	1 3/16"x1 3/8"	402	16.4	17.5	45	53	880	5 134,15
0431 03 3236	1 1/4"x1 7/16"	402	16.7	17.5	48	53	890	5 134,15
0431 03 3641	1 7/16"x1 5/8"	438	17.5	19.5	53	61	1100	5 182,35
0431 03 4146	1 11/16"x1 7/8"	485	19.5	20.5	61	67.5	1390	5 249,80
0431 03 4650	1 13/16"x2"	535	20.5	22.5	67.5	73.5	1955	5 397,45



0432

Yıldız İki Ağız Anahtar MASTER (mm) Double Ended Ring Wrench (mm) MASTER



TS 3794
TS ISO 10104 Form B
DIN 838



Saten krom yüzeyli, Krom vanadyum, Krom kaplı
Satin chrom finish, Chrom vanadium, Chrom plated

KOD CODE	mm	L mm	a1 mm	a2 mm	b1 mm	b2 mm	g	TL/Ad.
★0432 03 0607	6x7	176	5.6	6	10	11.5	55	10 22,95
★0432 03 1819	18x19	271	12	12.5	27.5	29	270	10 41,50
★0432 03 2528	25x28	352	14.5	15.5	38	42.5	550	5 66,55
★0432 03 2732	27x32	371	15	16.7	40.5	47.5	660	5 73,20

KOD CODE	İÇERİK CONTENTS	g	TL/Ad.
0431 00 2108	1/4"x5/16" - 5/16"x3/8" 7/16"x1/2" - 9/16"x5/8" 19/32"x11/16" 3/4"x25/32" - 13/16"x7/8" 15/16"x1"	1915	8 356,05
0431 00 2112	1/4"x5/16" - 5/16"x3/8" 3/8"x7/16" - 7/16"x1/2" 9/16"x5/8" - 19/32"x11/16" 3/4"x25/32" - 13/16"x7/8" 15/16"x1" - 1 1/16"x1 1/4" 1 1/8"x1 5/16" 1 3/16"x1 5/16"	3985	12 655,15

(★) İşaretli olan ürünler stoklarla sınırlıdır.
Limited with stocks.

Düz Yıldız Anahtar (mm)
Flat Ring Wrench (mm)

 TS 3794
 TS ISO 10103
 DIN 837 - B

2

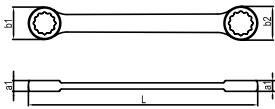
Krom vanadyum, Krom kaplı
Chrom vanadium, Chrom plated

KOD CODE	mm	L mm	a1 mm	b1 mm	b2 mm	g	TL/Ad.
0440 03 0607	6x7	99	4.4	9.5	11	10	20,90
0440 03 0809	8x9	113	5.2	12.5	14	25	21,85
0440 03 1011	10x11	125	6	15.5	16.5	30	24,25
0440 03 1213	12x13	140	6.8	18.5	20	45	26,15
0440 03 1415	14x15	156	7.2	21	22.5	60	30,50
0440 03 1617	16x17	170	8	24	25	80	36,15
0440 03 1819	18x19	188	8.8	26.5	27.5	105	37,80
0440 03 2022	20x22	208	9.6	29	32	135	43,90
0440 03 2123	21x23	230	10.6	30	33	170	52,00
0440 03 2426	24x26	256	10.8	35	37.5	225	52,65
0440 03 2528	25x28	280	11.8	36	40.5	270	61,50
0440 03 2732	27x32	310	12.8	38.5	45.5	355	76,00

ÖZEL SERİLER (adet ve termin süresi isteyiniz)
SPECIAL SERIES (ask for quantity and delivery terms)

0440 03 0810	8x10	120	5.6	12.5	15.5	30	10	23,40
0440 03 1013	10x13	140	6.6	15.5	20	45	10	26,15
0440 03 1315	13x15	156	7.2	20	22.5	55	10	30,50
0440 03 1317	13x17	170	8	20	25	85	10	36,15
0440 03 1618	16x18	188	8.6	24	26.5	90	10	37,80
0440 03 1719	17x19	188	8.8	25	27.5	105	10	37,80
0440 03 2224	22x24	230	10.8	32	35	170	10	52,00
0440 03 2427	24x27	256	10.8	35	38.5	225	10	52,65
0440 03 2729	27x29	290	12.8	38.5	42.5	285	10	70,30
0440 03 3032	30x32	310	12.8	43	45.5	360	10	76,00

0440
Düz Yıldız Anahtar Takımı (mm)
Flat Ring Wrench, Set (mm)

KOD CODE	İÇERİK CONTENTS	g	TL/Ad.
0440 00 2108	6x7 - 8x9 - 10x11 - 12x13 - 14x15 16x17 - 18x19 - 20x22	560	8 241,50
0440 00 2112	6x7 - 8x9 - 10x11 - 12x13 - 14x15 16x17 - 18x19 - 20x22 - 21x23 24x26 - 25x28 - 27x32	1540	12 483,65

 (★) İşaretli olan ürünler stoklarla sınırlıdır.
Limited with stocks.

0435

Süper İzoleli Bir Ağız Yıldız Anahtar (mm) Single Ended Ring Wrench Super Insulated (mm)

IEC 60900
⚡ 1000 V



Krom vanadyum, Krom kaplı, Kalın PVC izoleli
Chrom vanadium, Chrom plated, Triple PVC insulated

KOD CODE	mm	L mm	g	TL/Ad.
0435 03 0010	10	170	100	45,55
0435 03 0011	11	180	110	45,55
0435 03 0012	12	190	130	51,65
0435 03 0013	13	200	150	51,65
0435 03 0014	14	215	180	54,25
0435 03 0017	17	230	220	61,45
0435 03 0019	19	245	270	73,35
0435 03 0022	22	260	310	80,40
0435 03 0024	24	280	420	107,45

0530

Yarım Ay Anahtar Yıldız İki Ağız (mm) Double - Hex Starter and Block Wrench (mm)

TSEK

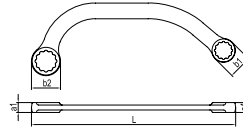

Krom vanadyum, Krom kaplı
Chrom vanadium, Chrom plated

KOD CODE	mm	L mm	a1 mm	b1 mm	b2 mm	g	TL/Ad.
0530 04 0810	8x10	120	6	12,5	15,5	30	26,95
0530 04 1011	10x11	150	7	17	20	55	31,65
0530 04 1012	10x12	150	7	17	20	55	31,65
0530 04 1113	11x13	150	7	17	20	55	31,65
0530 04 1315	13x15	185	9	21,5	26	110	37,75
0530 04 1317	13x17	185	9	21,5	26	105	37,75
0530 04 1417	14x17	185	9	21,5	26	110	37,75
0530 04 1517	15x17	185	9	21,5	26	100	37,75
0530 04 1922	19x22	230	11	29	33	195	49,15

0540

Rekor Anahtar (mm) Flarenut Wrench (mm)

DIN 3118

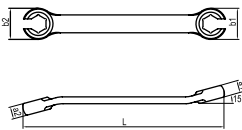

Krom vanadyum, Krom kaplı
Chrom vanadium, Chrom plated

KOD CODE	mm	L mm	a1 mm	a2 mm	b1 mm	b2 mm	g	TL/Ad.
0540 01 0810	8x10	130	7	8,5	18	20	60	38,85
0540 01 1011	10x11	150	8,5	9,3	20	22	75	40,35
0540 01 1012	10x12	150	8,5	9,3	20	22	75	40,35
0540 01 1113	11x13	170	9,3	10,8	22	25,5	105	43,20
0540 01 1214	12x14	170	9,3	10,8	22	25,5	105	43,20
0540 01 1719	17x19	210	11,8	13	30,5	33,5	185	77,15
0540 01 1922	19x22	230	12,8	14,9	33,5	39,5	235	92,40

0531

Yarım Ay Anahtar Yıldız İki Ağız (SAE) Double - Hex Starter and Block Wrench (SAE)

TSEK

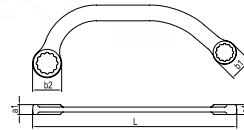

Krom vanadyum, Krom kaplı
Chrom vanadium, Chrom plated

KOD CODE	inch	L mm	a1 mm	b1 mm	b2 mm	g	TL/Ad.
0531 04 1112	7/16"x1/2"	150	7	17	20	50	39,05
0531 04 1214	1/2"x9/16"	185	9	21,5	26	110	45,40
0531 04 1416	9/16"x5/8"	185	9	21,5	26	115	46,80
0531 04 1922	3/4"x7/8"	230	11	29	33	195	59,00

ÖZEL SERİLER (adet ve termin süresi isteyiniz)
SPECIAL SERIES (ask for quantity and delivery terms)

0531 04 0809	5/16"x3/8"	120	6	12,5	15,5	30	10	32,30
0531 04 0911	3/8"x7/16"	150	7	17	20	50	10	38,00
0531 04 1417	9/16"x11/16"	185	9	21,5	26	110	10	45,25

(★) İşaretili olan ürünler stoklarla sınırlıdır.
Limited with stocks.

0700

Çatal Çakma Anahtar (mm)
Slugging Open Jaw Wrench (mm)

TS 81
DIN 133

0750

Yıldız Çakma Anahtar (mm)
Slugging Ring Wrench (mm)

TS 3794
DIN 7444

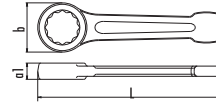
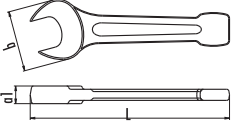
2

Krom vanadyum
Chrom vanadium

Krom vanadyum
Chrom vanadium

KOD CODE	mm	L mm	a1 mm	b mm	g	TL/Ad.
0700 05 0024	24	160	15	42	280	1 54,40
0700 05 0027	27	180	16	45	385	1 67,60
0700 05 0030	30	190	17	50	525	1 83,00
0700 05 0032	32	190	17	50	530	1 93,20
0700 05 0036	36	205	19	58	755	1 104,70
0700 05 0038	38	205	19	58	760	1 126,00
0700 05 0041	41	225	20	62	920	1 136,85
0700 05 0042	42	225	20	62	930	1 158,10
0700 05 0046	46	240	22	72	1305	1 174,00
0700 05 0047	47	240	22	72	1320	1 203,25
0700 05 0050	50	255	23	78	1565	1 217,45
0700 05 0055	55	272	25	88	2305	1 291,50
0700 05 0060	60	272	25	88	2310	1 316,45
0700 05 0065	65	300	28	98	3300	1 455,25
0700 05 0070	70	330	32	108	4555	1 582,85
0700 05 0075	75	330	32	108	4460	1 617,50
0700 05 0080	80	360	35	126	6115	1 785,30
0700 05 0085	85	360	35	126	5740	1 1041,05
0700 05 0090	90	390	40	140	8040	1 1071,15
0700 05 0095	95	390	40	140	8160	1 1142,25
0700 05 0100	100	420	44	148	12355	1 1619,00
0700 05 0105	105	420	44	148	11785	1 1669,45
0700 05 0110	110	450	48	166	15000	1 1904,95
0700 05 0115	115	450	48	166	14830	1 2188,30
0700 05 0120	120	490	54	178	18865	1 2309,85

ÖZEL SERİLER (adet ve termin süresi isteyiniz)
SPECIAL SERIES (ask for quantity and delivery terms)

0700 05 0125	125	490	54	178	17250	1	-----
0700 05 0130	130	518	59	196	20000	1	-----
0700 05 0135	135	518	59	196	19700	1	-----
0700 05 0140	140	518	59	196	19400	1	-----
0700 05 0145	145	580	62	223	28000	1	-----
0700 05 0150	150	580	62	223	27600	1	-----

KOD CODE	mm	L mm	a1 mm	b mm	g	TL/Ad.
0750 05 0024	24	160	15	42	235	1 76,35
0750 05 0027	27	180	16	46	325	1 91,10
0750 05 0030	30	190	17	52	435	1 108,75
0750 05 0032	32	190	17	52	425	1 124,95
0750 05 0036	36	205	19	59	550	1 141,40
0750 05 0038	38	205	19	59	530	1 169,30
0750 05 0041	41	225	20	64	730	1 184,90
0750 05 0042	42	225	20	64	700	1 211,40
0750 05 0046	46	240	22	73	970	1 221,05
0750 05 0047	47	240	22	73	930	1 243,95
0750 05 0050	50	255	23	78	1160	1 261,05
0750 05 0055	55	272	25	88	1520	1 367,20
0750 05 0060	60	272	25	88	1460	1 398,50
0750 05 0065	65	300	28	100	2025	1 520,95
0750 05 0070	70	330	32	109	2890	1 596,40
0750 05 0075	75	330	32	109	2755	1 638,30
0750 05 0080	80	360	35	123	4000	1 906,75
0750 05 0085	85	360	35	123	3620	1 1020,20
0750 05 0090	90	390	40	142	5465	1 1254,95
0750 05 0095	95	390	40	142	5250	1 1415,05
0750 05 0100	100	420	44	152	6755	1 1635,90
0750 05 0105	105	420	44	152	6445	1 1688,65
0750 05 0110	110	450	46	165	8500	1 1805,20
0750 05 0115	115	450	46	165	8460	1 2023,55
0750 05 0120	120	490	54	178	10000	1 2781,15

ÖZEL SERİLER (adet ve termin süresi isteyiniz)
SPECIAL SERIES (ask for quantity and delivery terms)

0750 05 0125	125	490	54	178	9900	1	-----
0750 05 0130	130	518	59	196	16000	1	-----
0750 05 0135	135	518	59	196	15900	1	-----
0750 05 0140	140	518	59	196	15800	1	-----
0750 05 0145	145	580	61.8	223	22000	1	-----
0750 05 0150	150	580	61.8	223	21900	1	-----
0750 05 0155	155	580	61.8	223	21800	1	-----
0750 05 0160	160	648	67	262	30100	1	-----
0750 05 0165	165	648	67	262	30000	1	-----
0750 05 0170	170	648	67	262	29800	1	-----
0750 05 0180	180	648	67	262	29700	1	-----

0550

Boru Uzatmalı Yıldız Anahtar (mm) Offset Ring Wrench (mm)



Krom vanadyum, Krom kaplı
Chrom vanadium, Chrom plated

KOD CODE	mm	L mm	a1 mm	b mm	øD mm	h mm	g	TL/Ad.
0550 05 0024	24	180	17	37	18.5	30	400	1 79,75
0550 05 0027	27	190	18	42	18.5	33	450	1 95,05
0550 05 0030	30	200	20	46	18.5	34	520	1 113,55
0550 05 0032	32	235	21.5	49	21.2	37	700	1 130,40
0550 05 0036	36	245	23	53.5	21.2	42	830	1 147,55
0550 05 0038	38	270	25	60.5	21.2	42	965	1 170,20
0550 05 0041	41	270	25	60.5	21.2	43	950	1 192,85
0550 05 0046	46	280	26	68	24.2	45	1240	1 230,75
0550 05 0050	50	290	28	74	24.2	47	1410	1 272,45
0550 05 0055	55	300	30	79	24.2	50	1550	1 383,20
0550 05 0060	60	345	32	89	29	50.5	2390	1 415,90
0550 05 0065	65	355	35	98	29	53	2730	1 450,30

ÖZEL SERİLER (adet ve termin süresi isteyiniz) SPECIAL SERIES (ask for quantity and delivery terms)

0550 05 0022	22	180	17	37	18.5	30	400	1	-----
0550 05 0034	34	235	21.5	49	21.2	37	750	1	-----
0550 05 0070	70	365	37	104	29	55	2900	1	-----
0550 05 0075	75	375	40	109	29	57.5	3100	1	-----
0550 05 0080	80	385	43	124	29	59	3900	1	-----
0550 05 0085	85	385	43	124	29	59	3750	1	-----
0550 05 0090	90	410	46	140	29	63	5100	1	-----
0550 05 0095	95	410	46	140	29	63	4950	1	-----
0550 05 0100	100	420	46	150	29	65	4800	1	-----

0551

Döndürme Kolu Borusu Tubular Handle



Dikişsiz Çelik Boru
Seamless Steel Pipe

KOD CODE	mm	L mm	ø mm	g	TL/Ad.
0551 05 0001	22 - 30	460	19	700	1 70,80
0551 05 0002	32 - 41	610	22	1220	1 95,95
0551 05 0003	46 - 55	760	25	1880	1 143,90
0551 05 0004	60 - 100	860	30	2975	1 194,25

0600

Kurbağacak Anahtar Adjustable Wrench

TS 3796
DIN 3117

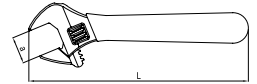

Yedek parça sayfa 196
Spare parts page 196

Krom vanadyum, Krom kaplı, PVC izoleli
Chrom vanadium, Chrom plated, PVC insulated

KOD CODE	L mm	L inch	a mm	g	TL/Ad.
0600 01 1006	160	6"	18	120	5 68,95
0600 01 1008	208	8"	23	230	5 93,50
0600 01 1010	260	10"	28	400	5 120,50
0600 01 1012	308	12"	34	670	5 166,60
0600 01 1015	388	15"	43	1555	1 261,10

0860

Kanca Anahtar (dörtgen uçlu) Hook Wrench

TS 3798 • DIN 1810

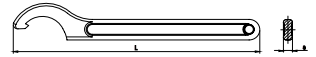

Krom vanadyum, Krom kaplı
Chrom vanadium, Chrom plated

KOD CODE	mm	L mm	a1 mm	g	TL/Ad.
0860 05 2528	25/28	136	4	50	10 39,15
0860 05 3032	30/32	136	4	50	10 39,15
0860 05 3436	34/36	170	5	95	10 42,30
0860 05 4042	40/42	170	5	95	10 42,30
0860 05 4550	45/50	210	6	160	10 49,10
0860 05 5255	52/55	210	6	160	10 49,10
0860 05 5862	58/62	242	7	270	5 59,20
0860 05 6875	68/75	242	7	270	5 59,20
0860 05 8090	80/90	281	8	400	5 77,25
0860 05 9510	95/100	281	8	400	5 77,25

Ayarlı Montaj Anahtarı
Adjustable Speed Wrench
2
**R&D
AR-GE**

Yedek parça sayfa 196
Spare parts page 196
Krom vanadyum, Krom kaplı
Chrom vanadium, Chrom plated

6 ile 22 mm arası **Altı Köşe, Torx, XZN, Ribe, Kare** gibi farklı geometriye sahip civataları açabilme imkanı sağlar. Anahtarı civata başından tam olarak çıkarmadan açma ve sıkma hareketi olanağı sağlar. Anahtar sapına özel olarak açılmış 10-13-15 mm altı köşe civataları açabilme imkanı sağlar

*Allows to open bolts with different geometry such as **Hexagon, Torx, XZN, Ribe, Square** in sizes from 6 to 22 mm. Enables unbolting and tightening turn without removing the wrench completely from the bolt head. Specially opened 10-13-15 mm holes on the handle, allows to open hexagon bolts.*

KOD CODE	L mm	L inch	a mm	g	TL/Ad.
0615 01 0200	200	8"	6-22	220	5 116,55



MCD ÇOK NOKTADAN TEMAS PROFİLİ / MCD MULTI CONTACT DRIVE PROFILE



2

İzeltaş Yeni Jenerasyon Yıldız Anahtar Profili

MCD, Multi Contact Drive (çoklu temas), sıkma performansının geliştirilmesi amacıyla dizayn edilmiştir. Bilgisayar destekli titiz çalışmaların sonucunda geliştirilen MCD, klasik 12 köşe anahtardan çok daha kullanışlı, çok daha güçlüdür.

En önemli özelliği, yıldız kafadaki çoklu temas yüzeyleridir. Bu sayede civata ve somunla maksimum temas sağlanır. Böylece basınç tüm köşelere eşit olarak dağılır, temas edilen yüzeylerdeki olası hasarlar önlenir, aletin ömrü uzar.

- Yıldız kafadaki yeni profil, düzenli bir dalga şeklindedir. Güç, civatanın köşelerine değil, yan yüzeylerine etki eder (çoklu temas). Basınç daha dengeli dağıldığından temas edilen yüzeylerde ezilme meydana gelmez.
- Tolerans dışı civatalar için de uygundur.
- Civata başlarının köşelerini ezmez.
- Geniş temas alanı, anahtar ömrünü arttırır.
- Bozuk ve deforme olmuş civataları kolayca açar.

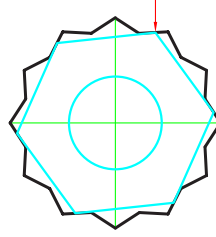

Çoklu Temas / Multi Point Contact

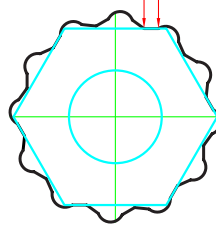

MCD Profil
MCD Profile

IZELTAS New Generation Ring Wrench Profile

MCD (Multi Contact Drive) is designed to improve the driving performance of the ring wrench. MCD, designed through computer aided drafting, transmits more torque and has longer life than conventional 12 edge ring profile.

Multi point contact is the source of effectiveness, where maximum surface area is in touch with fastener flats. Increased contact also maximizes tool's life through decreased pressure on the contact points.

- New profile of the ring wrench is formed of curves. Torque is transmitted through these curves rather than edges. As the stress is balanced between enlarged surfaces, the risk of deformation is minimized.
- It is possible to drive off-tolerance fasteners.
- Does not deform the fastener edges.
- Larger contact area increases tool's life.
- Works well with deformed fasteners.

MONTAJ ANAHTARI / SPEED WRENCH



%100 Daha Hızlı

Yeni tasarlanan montaj anahtarı, 2 kat hızını cırcır mekanizması mantığına dayanan çalışma prensibinden alır. Kullanım sırasında, montaj anahtarını civatadan ayırmadan döndürme kolaylığı kullanım hızını arttırırken, civata köşelerine sağlam tutunan anahtar profili güvenli ve kaydırmaz kullanım sağlar.

Uzun Ömür

Bu yeni montaj anahtarı profili, civata ve somunlar ile köşelerinden değil düz yüzeyleri üzerinden temas ederek düzenli tork iletimini sağlarken, gerilimin artmasını da engelleyerek anahtar ömrünün uzamasını sağlar.

- Anahtarı civatadan ayırmadan hızlı kullanım.
- Güvenli tork iletimi ve uzun ömür.

100% Faster

New designed speed wrench takes its 100% faster rotational drive from the ratchet mechanism principle. Rotating the tool without the need for removing from the fastener provides faster usage, while enabling safer and slip-free usage with fully gripping upper and lower jaws.

Longer Tool Life

This new speed wrench profile contacts the fasteners from their flats rather than edges, which provides balanced torque transmission and decreases stress accumulation on the edges increasing the tool life considerably.

- Fast drive without removing the wrench from the fastener.
- Firm torque transmission and longer life.

AYARLI MONTAJ ANAHTARI / ADJUSTABLE SPEED WRENCH



6 ile 22 mm arası altı köşe, torx, yive, ribe, kare gibi farklı geometriye sahip civataları açabilme imkanı sağlar. Anahtarı civata başından tam olarak çıkarmadan açma ve sıkma hareketi olanağı sağlar. Anahtar sapına özel olarak açılmış 10-13-15 mm altı köşe civataları açabilme imkanı sağlar

This tool is used for all different shapes of bolts between 6 and 22 mm. Contact between the tool and bolt is not removed to loosen and tighten the bolt. With the hexagonal holes in the handle, tool also can be used for 10-13-15mm bolts and nuts.



IZELTAS®

LOKMA VE BİJON ANAHTARLARI

SOCKETS AND RIM WRENCHES

Lokma Anahtarlar
Socket Wrenches

Lokma Takımları
Socket Wrench Sets

Kovan Anahtarlar
Tubular Socket Wrenches

Bijon Anahtarlar
Rim Wrenches

Tork Anahtarları
Torque Wrenches



Nikel üzeri krom kaplama ile korozyon direncinde üst seviye koruma
Corrosion protection with nickel over chrome plating

Yüksek dayanım için üst toleranslarda tasarım
Improved durability with upper tolerance thickness

En uygun temas yüzeyi için hassas dövülmüş altı köşe ağızlar
Precise forged hex shape for best contact area

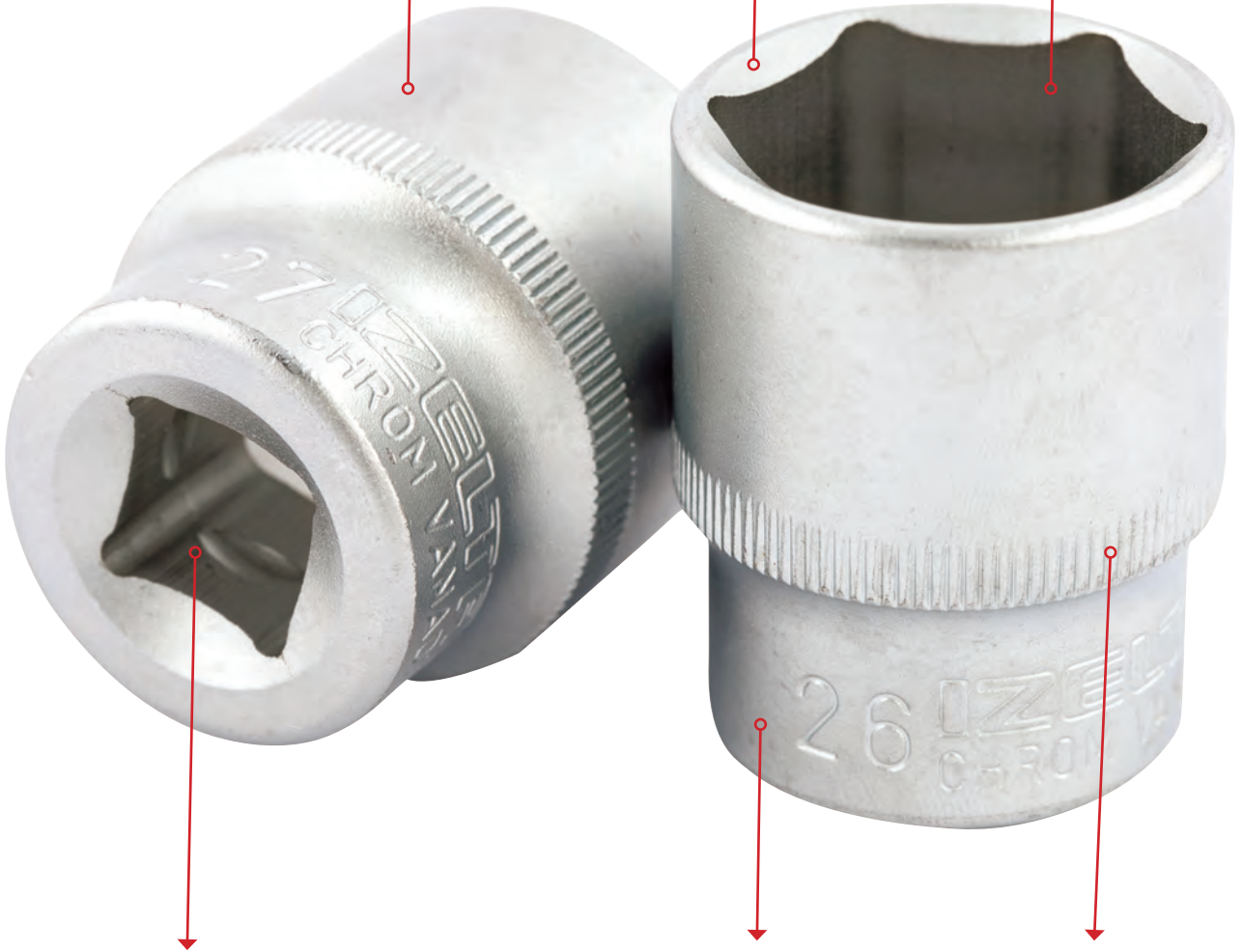

Bilya stoplama yuvalı hassas işlenmiş kare kanal
Precise machined square adapter with ball stopper
Groove

Yüksek mukavemetli alaşımli sıcak dövme çeliği
High strength alloyed forged steel

Extra sürtünme kabiliyeti için tırtıklı tasarım
Extra friction capability with knurled design

1107

1/4" Altı Köşe Lokma Anahtar (mm)
Socket Wrench 6 Points (mm)

TS ISO 2725 -1
DIN 3124

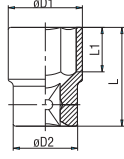

1/4"

Krom vanadyum, Krom kaplı, Polisajlı
Chrom vanadium, Chrom plated, Polished

KOD CODE	mm	ø D1 mm	ø D2 mm	L mm	L1 mm	g	TL/Ad.	
1107 06 0004	4	6.8	11.8	24.5	4	10	10	4,05
1107 06 0045	4.5	7.4	11.8	24.5	5	10	10	4,05
1107 06 0005	5	8	11.8	24.5	6	10	10	4,05
1107 06 0055	5.5	8.7	11.8	24.5	6	10	10	4,05
1107 06 0006	6	9.2	11.8	24.5	7	10	10	4,05
1107 06 0007	7	10.3	11.8	24.5	7	10	10	4,05
1107 06 0008	8	11.4	11.8	24.5	8	10	10	4,05
1107 06 0009	9	12.9	12.2	24.5	8	15	10	4,30
1107 06 0010	10	14.3	13	24.5	9	20	10	4,30
1107 06 0011	11	15.8	14.2	24.5	9	20	10	5,45
1107 06 0012	12	16.8	15.5	24.5	9	25	10	5,45
1107 06 0013	13	17.8	16.5	24.5	9	30	10	6,05

1207

1/4" Sekiz Köşe Lokma Anahtar (mm)
Socket Wrench 8 Points (mm)

TS ISO 2725 -1
DIN 3124



1/4"

Krom vanadyum, Krom kaplı, Polisajlı
Chrom vanadium, Chrom plated, Polished

KOD CODE	mm	ø D1 mm	ø D2 mm	L mm	g	TL/Ad.	
★1207 06 8008	8	12.2	12.2	24.5	15	10	6,50
★1207 06 8010	10	14.7	14.7	24.5	25	10	7,65

1107

1/4" Altı Köşe Derin Lokma Anahtar (mm)
Deep Socket Wrench 6 Points (mm)

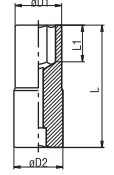

1/4"

Krom vanadyum, Krom kaplı, Polisajlı
Chrom vanadium, Chrom Plated, Polished

KOD CODE	mm	ø D1 mm	ø D2 mm	L mm	L1 mm	g	TL/Ad.	
1107 06 4004	4	6.8	11.8	50	6	10	10	8,00
1107 06 4005	5	8	11.8	50	7	20	10	8,00
1107 06 4055	5.5	8.7	11.8	50	9	20	10	8,00
1107 06 4006	6	9.2	11.8	50	9	25	10	8,95
1107 06 4007	7	10.3	11.8	50	15	25	10	8,95
1107 06 4008	8	11.8	11.8	50	15	25	10	8,95
1107 06 4009	9	13	13	50	15	30	10	8,95
1107 06 4010	10	14.5	14.5	50	15	40	10	8,95
1107 06 4011	11	15.8	15.8	50	21	45	10	9,65
1107 06 4012	12	16.8	16.8	50	21	50	10	9,65
1107 06 4013	13	17.8	17.8	50	21	55	10	9,65

1107

1/4" Derin Lokma Anahtar Takımı (14 parça, mm)
Socket Wrench Set Long Type (14 pcs, mm)



1/4"

KOD CODE	LOKMA LAR Sockets	AVADANLILIKLAR Accessories	g	TL/Ad.	
1107 00 6014	4-5-5.5-6 7-8-9-10 11-12-13 Altı Köşe Derin Lokma Deep Socket Wrench 6 Points	1/4" Cırcır Kol Ratchet Handle 1/4" Ara Kol Extension Bar 50 mm 1/4" Ara Kol Extension Bar 100 mm	1005	14	204,45

Havali aletler ile kullanmayınız / Do not use with power-tools

1107

1/4" Lokmalı Allen Uç
Hexagonal Bit Socket Wrench



1/4"

Krom vanadyum, Krom Kaplı
Chrom vanadium, Chrom Plated

KOD CODE	mm	L mm	g		TL/Ad.
1107 06 1125	2.5	37	13	10	6,65
1107 06 1103	3	37	13	10	6,65
1107 06 1104	4	37	15	10	6,65
1107 06 1105	5	37	15	10	6,65
1107 06 1106	6	37	15	10	6,65
1107 06 1107	7	37	16	10	7,85
1107 06 1108	8	37	17	10	7,85
1107 06 1110	10	37	19	10	9,45

1107

1/4" Lokmalı Star Delikli (Torx®) Uç
Tamper Resistant Torx
Bit Socket Wrench



1/4"

Krom vanadyum, Krom Kaplı
Chrom vanadium, Chrom Plated

KOD CODE		L mm	g		TL/Ad.
1107 06 1308	TR8	37	13	10	8,00
1107 06 1309	TR9	37	13	10	8,00
1107 06 1310	TR10	37	13	10	8,00
1107 06 1315	TR15	37	14	10	8,00
1107 06 1320	TR20	37	14	10	8,00
1107 06 1325	TR25	37	14	10	8,00
1107 06 1327	TR27	37	14	10	8,00
1107 06 1330	TR30	37	15	10	8,00
1107 06 1340	TR40	37	16	10	9,35

1107

1/4" Lokmalı Star (Torx®) Uç
Torx Bit Socket Wrench



1/4"

Krom vanadyum, Krom Kaplı
Chrom vanadium, Chrom Plated

KOD CODE		L mm	g		TL/Ad.
1107 06 1208	T8	37	12	10	6,85
1107 06 1209	T9	37	12	10	6,85
1107 06 1210	T10	37	13	10	6,85
1107 06 1215	T15	37	14	10	6,85
1107 06 1220	T20	37	14	10	6,85
1107 06 1225	T25	37	14	10	6,85
1107 06 1227	T27	37	14	10	6,85
1107 06 1230	T30	37	15	10	6,85
1107 06 1240	T40	37	16	10	6,85

1107

1/4" Lokma Düz Uç
Slotted Bit Socket Wrench



1/4"

Krom vanadyum, Krom Kaplı
Chrom vanadium, Chrom Plated

KOD CODE		L mm	g		TL/Ad.
1107 06 1403	3	37	13	10	6,65
1107 06 1435	3.5	37	14	10	6,65
1107 06 1404	4	37	14	10	6,65
1107 06 1445	4.5	37	14	10	6,65
1107 06 1455	5.5	37	15	10	6,65
1107 06 1465	6.5	37	15	10	6,65
1107 06 1407	7	37	16	10	6,65
1107 06 1408	8	37	16	10	8,05
1107 06 1410	10	37	17	10	8,70

1107

1/4" Lokmalı Yıldız Uç
Phillips Bit Socket Wrench

1/4"

Krom vanadyum, Krom Kaplı
Chrom vanadium, Chrom Plated

KOD CODE	+	L mm	g	□	TL/Ad.
1107 06 1501	Ph 1	37	14	10	6,65
1107 06 1502	Ph 2	37	14	10	6,65
1107 06 1503	Ph 3	37	15	10	6,65
1107 06 1504	Ph 4	37	16	10	6,65

1107

1/4" Bits Uçlu Lokma Takımı (42 Parça)
Bit Socket Wrench Set (42 Pcs)

1/4"

KOD CODE	İÇERİK CONTENTS	□	TL/Ad.
1107 00 1042	1/4" Lokmalı Star Torx® Uçlar Torx® Bit Socket T8-T9-T10-T15-T20-T25-T27-T30-T40	42	401,30
	1/4" Lokmalı Star Delikli Torx® Uçlar Tamper Resistant Torx® Bit Socket Wrench TR8-TR9-TR10-TR15-TR20-TR25-TR27 TR30-TR40		
	1/4" Lokmalı Allen Uçlar Hexagonal Bit Socket Wrench 2.5-3-4-5-6-7-8-10		
	1/4" Lokmalı Düz Uç Slotted Bit Socket Wrench 3-3.5-4-4.5-5.5 6.5-7-8-10		
	1/4" Lokmalı Yıldız Uç Phillips Bit Socket Wrench Ph1-Ph2-Ph3-Ph4		
	1/4" Cırcır kolu Ratchet Handle		
	1/4" Ara Kol Extension Bar 100 mm		
	1/4" Lokma Tornavida Adaptörü Spindle Handle		

1507

1/4" Cırcır Kolu
Ratchet Wrench

TS ISO 3315

1/4"

Krom vanadyum, Krom kaplı, Polisajlı
Chrom vanadium, Chrom plated, Polished

KOD CODE	L mm	g	□	TL/Ad.
1507 06 2140	140	140	5	82,75

1507

1/4" Ara Kol
Extension Bar

 TS ISO 1174
DIN 3123

1/4"

Krom vanadyum, Krom kaplı, Polisajlı
Chrom vanadium, Chrom plated, Polished

KOD CODE	L mm	g	□	TL/Ad.
1507 06 0050	50	25	5	11,50
1507 06 0100	100	45	5	12,50

1507

1/4" Mafsal
Universal Joint

 TS ISO 1174
DIN 3123

1/4"

Krom vanadyum, Krom kaplı, Polisajlı
Chrom vanadium, Chrom plated, Polished

KOD CODE	L mm	g	□	TL/Ad.
1507 06 0038	38	25	5	21,15

1507

1/4" T Kol
Sliding T - Handle

 TS ISO 3315
DIN 3122

1/4"

Krom vanadyum, Krom kaplı, Polisajlı
Chrom vanadium, Chrom plated, Polished

KOD CODE	L mm	g	□	TL/Ad.
1507 06 4115	115	45	5	19,25

1507

1/4" Lokma Adaptörü
Adapter

TS ISO 1174
DIN 3123



1/4"

Krom vanadyum, Krom kaplı, Polisajlı
Chrom vanadium, Chrom plated, Polished

KOD CODE	inch	g		TL/Ad.
1507 06 0004	1/4"Fx3/8"M	20	5	13,85

1507

1/4" Derin Lokma Tornavida Adaptörü
Spindle Handle

DIN 3122

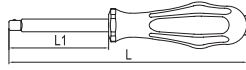

1/4"

Krom vanadyum, Krom kaplı, Polisajlı, Selüloz Asetat Saplı
Chrom vanadium, Chrom plated, Polished, Cellulose Acetate Handle

KOD CODE	L mm	L1 mm	g		TL/Ad.
1507 06 4080	150	65	100	10	22,75

1107

1/4" Bits Tutucu Lokma (Mıknatıslı)
Bit Holder Socket



1/4"

Krom vanadyum
Chrom vanadium

KOD CODE	Inch	g		TL/Ad.
1107 06 5010	1/4"F - 1/4"F	15	5	13,20

1107

1/4" Altı Köşe Lokma Anahtar Takımı (15 parça, mm)
Socket Wrench Set 6 Points (15 pcs, mm)



1/4"

KOD CODE	LOKMALAR Sockets	AVADANLIKLAR Accessories	g		TL/Ad.
		1/4" Cırcır kolu Ratchet Handle			
		1/4" Mafsal Universal Joint			
	4 - 5 - 6 7 - 8 - 9 - 10 11 - 12 - 13	1/4" T Kol Sliding T Handle			
1107 00 6015	Altı Köşe Six Points		960	15	192,95
		1/4" Ara Kol Extension Bar 50 mm			
		1/4" Ara Kol Extension Bar 100 mm			

1110

3/8" Altı Köşe Lokma Anahtar (mm) Socket Wrench 6 Points (mm)

TS ISO 2725 - 1
DIN 3124



3/8"

Krom vanadyum, Krom kaplı, Polisajlı
Chrom vanadium, Chrom plated, Polished

KOD CODE	mm	ø D1 mm	ø D2 mm	L mm	L1 mm	g	TL/Ad.
1110 06 0006	6	9.8	17.8	27	9	25	10
1110 06 0007	7	10.8	17.8	27	9	25	10
1110 06 0008	8	12	17.8	27	9	25	10
1110 06 0009	9	13.2	17.8	27	9	25	10
1110 06 0010	10	14.5	17.8	27	9	25	10
1110 06 0011	11	15.8	17.8	27	9	30	10
1110 06 0012	12	16.8	17.8	27	9	30	10
1110 06 0013	13	17.8	16.8	27	9	30	10
1110 06 0014	14	19.6	17.5	29	11	35	10
1110 06 0015	15	20.8	18	29	11	45	10
1110 06 0016	16	21.8	19	29	11	45	10
1110 06 0017	17	23.4	20	29	11	55	10
1110 06 0018	18	24.7	21	29	13	60	10
1110 06 0019	19	25.8	22	29	13	65	10
1110 06 0021	21	27.8	24	32	13	80	10
1110 06 0022	22	29.7	26	32	15	85	10
1110 06 0023	23	29.7	26	32	15	90	10

1110

3/8" Buji Lokma Anahtar Lastikli Spark Plug Socket with Rubber

TS ISO 2725 - 1



3/8"

Krom vanadyum, Krom kaplı, Polisajlı
Chrom vanadium, Chrom plated, Polished

KOD CODE	mm	L mm	g	TL/Ad.
1110 06 9208	21	70	145	10

1510

3/8" Cırcır Kolu Ratchet Handle

TS ISO 3315
DIN 3122



3/8"

Krom vanadyum, Krom kaplı, Polisajlı
Chrom vanadium, Chrom plated, Polished

KOD CODE	L mm	g	TL/Ad.
1510 06 0200	200	295	5

1510

3/8" Ara Kol Extension Bar

TS ISO 1174
DIN 3123



3/8"

Krom vanadyum, Krom kaplı, Polisajlı
Chrom vanadium, Chrom plated, Polished

KOD CODE	L mm	g	TL/Ad.
1510 06 0075	75	75	5
1510 06 0150	150	145	5

1510

3/8" Mafsal Universal Joint

TS ISO 1174
DIN 3123



3/8"

Krom vanadyum, Krom kaplı, Polisajlı
Chrom vanadium, Chrom plated, Polished

KOD CODE	L mm	g	TL/Ad.
1510 06 0056	56.5	60	5

Havali aletler ile kullanmayınız / Do not use with power-tools

1510

3/8" T Kol
Sliding T - Handle

TS ISO 3315
DIN 3122



1110

3/8" Altı Köşe Lokma Takımı (19 parça, mm)
6 Points Socket Wrench Set (19 Pcs, mm)



3

3/8"

Krom vanadyum, Krom kaplı, Polisajlı
Chrom vanadium, Chrom plated, Polished

KOD CODE	L mm	g		TL/Ad.
1510 06 1200	200	180	5	43,15

1510

3/8" Lokma Adaptörü
Adapter

TS ISO 1174
DIN 3123



3/8"

Krom vanadyum, Krom kaplı, Polisajlı
Chrom vanadium, Chrom plated, Polished

KOD CODE	inch	g		TL/Ad.
1510 06 0007	3/8"Fx1/2"M	45	5	23,65

1510

3/8" Mafsallı Kol
Flexible Handle

TS ISO 3315
DIN 3122



3/8"

Krom vanadyum, Krom kaplı, Polisajlı
Chrom vanadium, Chrom plated, Polished

KOD CODE	L mm	g		TL/Ad.
★1510 06 0215	215	310	5	73,75



3/8"

KOD CODE	LOKMA LAR Sockets	AVADAN LIKLAR Accessories	g		TL/Ad.
		3/8" Cırcır Kolu Ratchet Handle			
		3/8" Mafsal Universal Joint			
	6 - 7 - 8 - 9 10 - 11 - 12 13 - 14 - 17 19 - 21 - 23				
	Altı Köşe Six Points	3/8" T Kol Sliding T Handle	1089	19	444,65
1110 00 6019	20.8 Buji Lokma Lastikli Altı Köşe Spark Plug Socket With Rubber	3/8" Ara Kol Extension Bar 75 mm			
		3/8" Ara Kol Extension Bar 150 mm			

Havali aletler ile kullanmayınız / Do not use with power-tools

1113

1/2" Lokma Anahtar Sehpası (145 Parça)
Display Frame for Sockets (145 Pcs)

1/2"

KOD CODE	İÇERİK CONTENTS	g		TL/Ad.
	Dolu/Full			
	10-11-12 13-14-15 16-17-18-19 10 adet /10 Pcs			
1113 00 6145		18.236	1	3148,00
	21-22-23 24-26-27 28-30-32 5 Adet / 5 Pcs			

1113

1/2" Altı Köşe Lokma Anahtar (mm)
Socket Wrench 6 Points (mm)

TS ISO 2725 -1
DIN 3124

1/2"

Krom vanadyum, Krom kaplı
Chrom vanadium, Chrom plated

KOD CODE	mm	Ø D1 mm	Ø D2 mm	L mm	L1 mm	g		TL/ Ad.
1113 06 1008	8	13.2	21.8	38	7	55	10	13,45
1113 06 1009	9	14	21.8	38	7	55	10	13,45
1113 06 1010	10	15	23.3	38	8	55	10	16,75
1113 06 1011	11	16.4	23.3	38	8	60	10	16,75
1113 06 1012	12	17.8	23.3	38	9	60	10	16,75
1113 06 1013	13	19	23.3	38	10	65	10	18,00
1113 06 1014	14	20.4	23.3	38	11	65	10	18,00
1113 06 1015	15	21.6	23.3	38	11	65	10	18,00
1113 06 1016	16	22.9	24	38	11	70	10	18,85
1113 06 1017	17	24	22.5	38	12	70	10	18,85
1113 06 1018	18	25.2	23	38	13	75	10	18,85
1113 06 1019	19	26.8	23	38	13	75	10	19,70
1113 06 1020	20	28	23	38	13	80	10	19,70
1113 06 1021	21	29.2	23	38	13	85	5	19,70
1113 06 1022	22	30.2	24	40	15	95	5	19,70
1113 06 1023	23	31.4	25	40	15	100	5	20,50
1113 06 1024	24	32.6	26	42	17	115	5	20,50
1113 06 1025	25	34	27	42	17	125	5	20,50
1113 06 1026	26	35.3	28	42	17	135	5	20,50
1113 06 1027	27	36.6	28	42	19	140	5	23,55
1113 06 1028	28	37.8	30	42	20	160	5	23,55
1113 06 1029	29	39	30	44	21	170	5	24,80
1113 06 1030	30	40	29.5	44	21	180	5	24,80
1113 06 1032	32	42.5	30	44	23	190	5	25,80



Havali aletler ile kullanmayınız / Do not use with power-tools

1114

1/2" On İki Köşe Lokma Anahtar (mm)
Socket Wrench 12 Points (mm)

TS ISO 2725 - 1
DIN 3124

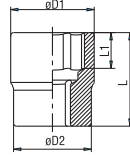

1/2"

Krom vanadyum, Krom kaplı
Chrom vanadium, Chrom plated

KOD CODE	Ø mm	Ø D1 mm	Ø D2 mm	L mm	L1 mm	g	TL/Ad.	
1114 06 1010	10	15	23.3	38	8	60	10	17,90
1114 06 1011	11	16.4	23.3	38	8	60	10	17,90
1114 06 1012	12	17.8	23.3	38	9	60	10	17,90
1114 06 1013	13	19	23.3	38	10	60	10	19,35
1114 06 1014	14	20.4	23.3	38	11	60	10	19,35
1114 06 1015	15	21.6	23.3	38	11	65	10	19,35
1114 06 1016	16	22.9	24	38	11	70	10	20,15
1114 06 1017	17	24	22.5	38	12	70	10	20,15
1114 06 1018	18	25.2	23	38	13	70	10	20,15
1114 06 1019	19	26.8	23	38	13	75	10	21,10
1114 06 1020	20	28	23	38	13	80	10	21,10
1114 06 1021	21	29.2	23	38	13	80	5	21,10
1114 06 1022	22	30.2	24	40	15	95	5	21,10
1114 06 1023	23	31.4	25	40	15	100	5	22,00
1114 06 1024	24	32.6	26	42	17	105	5	22,00
1114 06 1026	26	35.3	28	42	17	135	5	22,00
1114 06 1027	27	36.6	28	42	19	135	5	25,15
1114 06 1028	28	37.8	30	42	20	155	5	25,15
1114 06 1030	30	40	30	44	21	165	5	26,40
1114 06 1032	32	42.5	30	44	23	180	5	27,70



Havali aletler ile kullanmayınız / Do not use with power-tools

1413

1/2" On İki Köşe Lokma Anahtar (SAE)
Socket Wrench 12 Points (SAE)

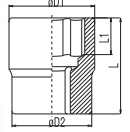

1/2"

Krom vanadyum, Krom kaplı
Chrom vanadium, Chrom plated

KOD CODE	Ø inch	Ø D1 mm	Ø D2 mm	L mm	L1 mm	g	TL/Ad.	
1413 06 1008	5/16"	13.2	21.8	37	6	45	10	19,20
1413 06 1095	3/8"	15	21.8	37	8	50	10	19,20
1413 06 1010	7/16"	16.4	23.3	37	9	60	10	19,85
1413 06 1011	15/32"	18	23.3	37	9	60	10	19,85
1413 06 1012	1/2"	19	23.3	37	9	60	10	20,65
1413 06 1013	9/16"	20.4	23.3	37	11	60	10	21,40
1413 06 1014	19/32"	21.6	23.3	37	11	65	10	21,40
1413 06 1015	5/8"	23.1	22	38	11	70	10	21,60
1413 06 1016	11/16"	24.5	22.5	38	11	70	10	22,35
1413 06 1017	3/4"	26.8	23	38	13	75	10	22,55
1413 06 1020	25/32"	28	23	38	13	75	10	23,35
1413 06 1021	13/16"	28.6	23	38	13	80	10	23,35
1413 06 1022	7/8"	30.2	24	40	15	90	5	23,35
1413 06 1024	15/16"	32.6	26	42	17	115	5	24,40
1413 06 1025	1"	35	28	42	17	130	5	24,40
1413 06 1027	1 1/16"	36.6	28	42	19	135	5	32,00
1413 06 1029	1 1/8"	38.8	30	42	19	170	5	32,00
1413 06 1030	1 3/16"	40	29.5	44	20	170	5	32,00
1413 06 1032	1 1/4"	42.5	30	44	22	185	5	32,00

1113

1/2" Buji Lokma Anahtar (Lastikli)
Spark Plug Socket with Rubber



1/2"

Krom vanadyum, Krom kaplı, Polisajlı
Chrom vanadium, Chrom plated, Polished

KOD CODE	Ø mm	L mm	g	TL/Ad.	
1113 06 9160	16	70	80	10	25,35
1113 06 9208	21	70	155	10	27,80

(★) İşaretili olan ürünler stoklarla sınırlıdır.
Limited with stocks.

1108

1/2" Altı Köşe Derin Lokma Anahtar (mm)
Deep Socket Wrench 6 Points (mm)

TS ISO 2725 - 1
DIN 3124

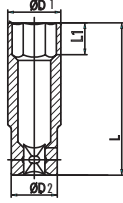

1/2"

Krom vanadyum, Krom kaplı
Chrom vanadium, Chrom plated

KOD CODE	Ø mm	ØD1 mm	ØD2 mm	L mm	L1 mm	g	TL/Ad.
1108 06 0010	10	15,5	24	75	6	110	10
1108 06 0011	11	16,7	24	75	7	110	10
1108 06 0012	12	18	24	75	8	110	10
1108 06 0013	13	19,2	24	75	8	120	10
1108 06 0014	14	20,5	24	75	10	120	10
1108 06 0015	15	21,7	24	75	10	140	10
1108 06 0016	16	23	25,5	75	10	140	10
1108 06 0017	17	24,2	25,5	75	10	140	10
1108 06 0018	18	25,5	25,5	75	12	150	10
1108 06 0019	19	26,7	26,7	75	12	150	10

1108

1/2" Altı Köşe Derin Lokma Anahtar Takımı (10 parça mm)
Deep Socket Set (10 pcs. mm)



1/2"

KOD CODE	L mm	g	TL/Ad.
1108 00 6010	10-11-12-13-14-15 16-17-18-19	1290	10
			360,30

1113

1/2" Star Lokma Anahtar
Star Socket

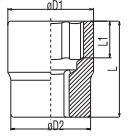

1/2"

Krom vanadyum, Krom kaplı
Chrom vanadium, Chrom plated

KOD CODE	Ø D1 mm	Ø D2 mm	L mm	L1 mm	g	TL/Ad.	
1113 06 0210	E10	13.2	23.8	37	7.5	60	10
1113 06 0212	E12	15	23.8	37	9	65	10
1113 06 0214	E14	16.4	23.8	37	10	65	10
1113 06 0216	E16	18.8	23.8	37	11	70	10
1113 06 0218	E18	20.5	23.8	39	12.5	75	10
1113 06 0220	E20	23	23.8	39	14	75	10

1113

1/2" Star (Torx®) Lokma Anahtar Takımı (7 Parça)
Star Torx® Socket Wrench Set (7 Pcs)



1/2"

KOD CODE	İÇERİK CONTENTS	g	TL/Ad.
1113 00 6007	Star Lokma / Star Socket E10 - E12 - E14 - E16 - E18 - E20 125 mm ara kol / Extension Bar	1075	7
			133,40

Havallı aletler ile kullanmayınız / Do not use with power-tools

1113

1/2" Lokmalı Allen Uç
Hexagonal Bit Socket Wrench



3



1/2"

Krom vanadyum, Krom kaplı
Chrom vanadium, Chrom plated

KOD CODE	mm	L mm	g		TL/Ad.
1113 06 1105	5	60	70	10	21,75
1113 06 1106	6	60	70	10	21,75
1113 06 1107	7	60	75	10	21,75
1113 06 1108	8	60	75	10	21,75
1113 06 1110	10	60	85	10	24,85
1113 06 1112	12	60	100	10	24,85
1113 06 1114	14	60	115	10	24,85
1113 06 4105	5	100	90	10	22,70
1113 06 4106	6	100	90	10	22,70
1113 06 4107	7	100	90	10	22,70
1113 06 4108	8	100	95	10	22,70
1113 06 4110	10	100	105	10	26,25
1113 06 4112	12	100	145	10	26,25
1113 06 4114	14	100	155	10	31,65
1113 06 4117	17	100	200	10	42,30

1113

1/2" Lokmalı Star (Torx®) Uç
Star (Torx) Bit Socket Wrench



1/2"

Krom vanadyum, Krom kaplı
Chrom vanadium, Chrom plated

KOD CODE	☆	L mm	g		TL/Ad.
1113 06 1220	T20	60	70	10	26,85
1113 06 1225	T25	60	70	10	26,85
1113 06 1227	T27	60	70	10	26,85
1113 06 1230	T30	60	70	10	26,85
1113 06 1240	T40	60	70	10	26,85
1113 06 1245	T45	60	70	10	26,85
1113 06 1250	T50	60	75	10	26,85
1113 06 1255	T55	60	80	10	26,85
1113 06 1260	T60	60	100	10	26,85
1113 06 4220	T20	100	78	10	27,95
1113 06 4225	T25	100	79	10	27,95
1113 06 4227	T27	100	80	10	27,95
1113 06 4230	T30	100	80	10	27,95
1113 06 4240	T40	100	80	10	27,95
1113 06 4245	T45	100	82	10	27,95
1113 06 4250	T50	100	82	10	27,95
1113 06 4255	T55	100	100	10	27,95
1113 06 4260	T60	100	134	10	27,95

1113

1/2" Lokmalı Allen Uç Takımı (60 mm, 7 Parça)
Hexagonal Bits Socket Wrench Set (60 mm, 7 Pcs)

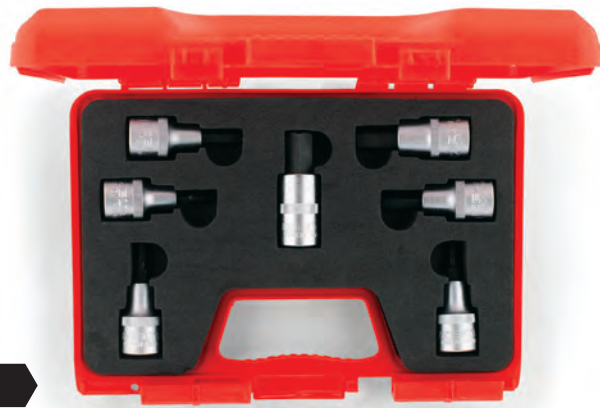

1/2"

KOD CODE	İÇERİK CONTENTS	g		TL/Ad.
1113 00 1107	Allen Uçlar 60mm Hex Bit Socket 5-6-7-8-10-12-14	1040	7	161,55

1113

1/2" Lokmalı Torx® Uç Takımı (60 mm, 9 parça)
Torx® Bits Socket Wrench Set (60 mm, 9 Pcs)

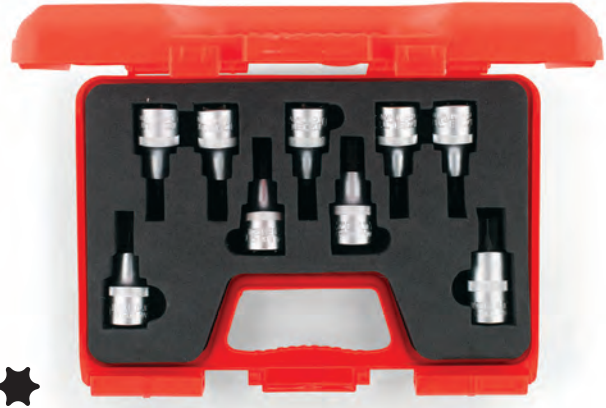

1/2"

KOD CODE	İÇERİK CONTENTS	g		TL/Ad.
1113 00 6009	Torx® Uçlar 60mm Star Socket T20 - T25 - T27 - T30 - T40 - T45 T50 - T55 - T60	1125	9	241,65

Havali aletler ile kullanmayınız / Do not use with power-tools

1113

1/2" Lokmalı Allen Uç ve Star (Torx)® Uç Takımı (17 Parça)
Hex Bit Sockets - Torx Bit Sockets Set (17 Pcs)

1/2"

KOD CODE	İÇERİK CONTENTS		TL/Ad.
1113 00 6017	T Kol (1/2") Sliding T Handle		475,95
	5 - 6 - 7 - 8 - 10 - 12 - 14 Lokmalı Allen Uç 60mm Hex Bit Socket		
	T20 - T25 - T27 T30 - T40 T45 - T50 - T55 - T60 Lokmalı Torx Allen Uç 60mm Torx Bit Socket	17	

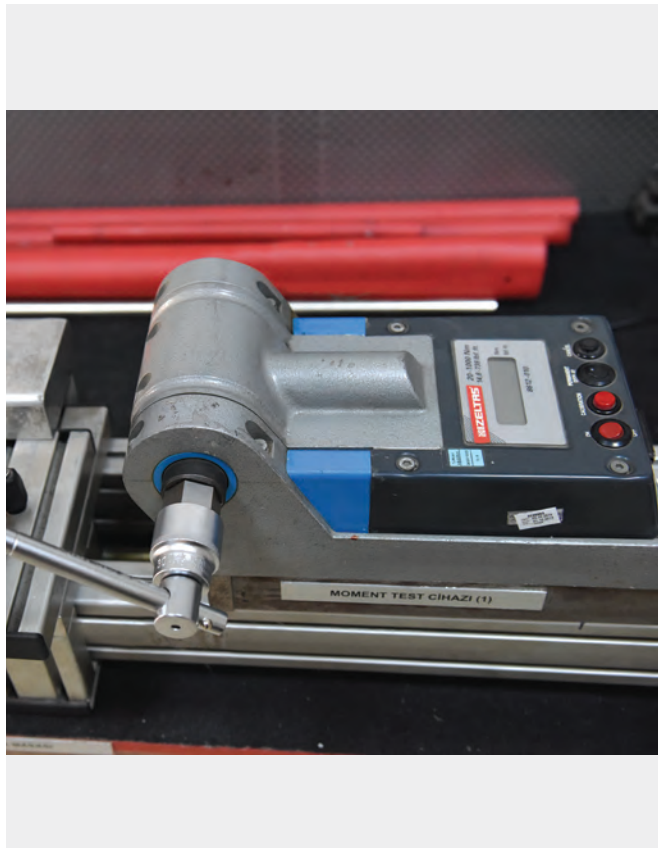

Havali aletler ile kullanmayınız / Do not use with power-tools

1114

1/2" On İki Köşe Lokmalı Bits Uç Yivli (XZN)
Hex Bit Socket 12 Points (XZN)

1/2"

Krom vanadyum, Krom kaplı
Chrom vanadium, Chrom plated

3

KOD CODE		L mm	g		TL/Ad.
1114 06 4005	M5	60	60	10	18,10
1114 06 4006	M6	60	62	10	18,10
1114 06 4008	M8	60	62	10	18,10
1114 06 4010	M10	60	78	10	18,10
1114 06 4012	M12	60	84	10	21,45
1114 06 4106	M6	80	69	10	22,80
1114 06 4108	M8	80	70	10	22,80
1114 06 4110	M10	80	84	10	25,15
1114 06 4112	M12	80	103	10	26,00
1114 06 4114	M14	80	133	10	27,85
1114 06 4208	M8	140	96	10	25,60
1114 06 4210	M10	140	125	10	31,40
1114 06 4212	M12	140	161	10	35,40
1114 06 4214	M14	140	210	10	39,75
1114 06 4216	M16	140	281	10	57,65

1114

1/2" Lokmalı (Ribe) Bits Uç
Socket Wrench 6 Points

1/2"

Krom vanadyum, Krom kaplı
Chrom vanadium, Chrom plated

KOD CODE		L mm	g		TL/Ad.
1114 06 5004	4	100	75	10	27,15
1114 06 5005	5	100	76	10	27,15
1114 06 5006	6	100	76	10	27,15
1114 06 5007	7	100	77	10	27,15
1114 06 5008	8	100	78	10	27,15
1114 06 5009	9	100	85	10	27,40
1114 06 5010	10	100	96	10	27,40
1114 06 5011	10.5	100	96	10	28,00
1114 06 5012	12	100	121	10	34,90
1114 06 5013	13	100	148	10	38,30
1114 06 5014	14	100	150	10	38,30
1114 06 5016	16	100	198	10	51,85

(*) İşaretili olan ürünler stoklarla sınırlıdır.
Limited with stocks.

1513

1/2" Cırcır Kolu (32 Diş)
Ratchet Handle

TS ISO 3315
DIN3122



Krom vanadyum, Krom kaplı
Chrom vanadium, Chrom plated

1/2"

KOD CODE	L mm	g		TL/Ad.
1513 06 0032	250	580	5	137,60

1513

1/2" T Kol
Sliding T - Handle

TS ISO 3315
DIN 3122



Krom vanadyum, Krom kaplı
Chrom vanadium, Chrom plated

1/2"

KOD CODE	L mm	g		TL/Ad.
1513 06 2250	250	355	5	72,75

3

1513

1/2" Cırcır Kolu (72 Diş)
Max Gear Ratchet Handle

TS ISO 3315



Krom vanadyum, Krom kaplı
Chrom vanadium, Chrom plated

1/2"

KOD CODE	L mm	g		TL/Ad.
★1513 06 0072	250	460	5	243,70

1513

1/2" Mafsal
Universal Joint

TS ISO 1174
DIN 3123



Krom vanadyum, Krom kaplı
Chrom vanadium, Chrom plated

1/2"

KOD CODE	L mm	g		TL/Ad.
1513 06 4070	70	140	5	54,25

1513

1/2" Ara Kol
Extension Bar

TS ISO 1174
DIN 3123



Krom vanadyum, Krom kaplı
Chrom vanadium, Chrom plated

1/2"

KOD CODE	L mm	g		TL/Ad.
1513 06 4075	75	140	5	27,25
1513 06 4125	125	215	5	33,25
1513 06 4250	250	420	5	55,75

1513

1/2" Lokma Adaptörü
Adapter

TS ISO 1174
DIN 3123



Krom vanadyum, Krom kaplı
Chrom vanadium, Chrom plated

1/2"

KOD CODE	inch	g		TL/Ad.
1513 06 0002	1/2"Fx3/8"M	55	5	18,30
1513 06 0003	1/2"Fx3/4"M	115	5	28,85

1513

1/2" T Kol Adaptörü
Adapter



Krom vanadyum, Krom kaplı
Chrom vanadium, Chrom plated

1/2"

KOD CODE	inch	g		TL/Ad.
1513 06 5250	3/8"Fx1/2"M	90	5	31,00

1113

1/2" Bits Tutucu Lokma
Bit Holder Scket



**YENİ
NEW**

Krom vanadyum
Chrom vanadium

1/2"

KOD CODE	Inch	g		TL/Ad.
1113 06 5010	1/2" F - 1/4" F	50	5	17,70

Havali aletler ile kullanmayınız / Do not use with power-tools

1113 00 1038

1/4" - 1/2" Altı Köşe Lokma Anahtar Takımı (35 Parça)
Socket Wrench Set 6 Point 1/4" - 1/2" (35 Pcs)

YENİ
NEW



3

KOD CODE	LOKMALAR Sockets	AVADANLIKLAR Accessories	g	TL/Ad.
1113 00 1038	4 - 5 - 6 7 - 8 - 9 - 10 11 - 12 - 13 Altı Köşe Six Points	1/4" Cırcır kolu Ratchet Handle 1/4" Mafsal Universal Joint 1/4" T Kol Sliding T Handle 1/4" Ara Kol Extension Bar 50 mm 1/4" Ara Kol Extension Bar 100 mm 1/2" Cırcır Kolu Ratchet Handle 1/2" T Kol Adaptör Sliding T Handle Adapter 1/2" Ara Kol Extension Bar 75 mm 1/2" Ara Kol Extension Bar 250 mm	4000	35 759,10

Havali aletler ile kullanmayınız / Do not use with power-tools

75

(*) İşaretili olan ürünler stoklarla sınırlıdır.
Limited with stocks.

1113

1/2" Altı Köşe Lokma Anahtar Takımı (17 Parça, mm)
Socket Wrench Set 6 Points (17 pcs, mm)

3
1/2"

KOD CODE	LOKMALAR Sockets	AVADANLIKLAR Accessories	g	TL/Ad.
1113 00 2017		1/2" Cırcır Kolu Ratchet Handle	2880	17
		1/2" T Kol Adaptör Sliding T Handle Adapter		
	10 - 11 - 12 13 - 14 - 15 17 - 19 - 22 24 - 27 - 30 32	1/2" Mafsal Universal Joint		
		1/2" Ara Kol Extension Bar 250 mm		

1113

1/2" Altı Köşe Lokma Anahtar Takımı (24 Parça, mm)
Socket Wrench Set 6 Points (24 pcs, mm)

1/2"

KOD CODE	LOKMALAR Sockets	AVADANLIKLAR Accessories	g	TL/Ad.
1113 00 2024		1/2" Cırcır Kolu Ratchet Handle	3650	24
		1/2" Mafsal Universal Joint		
	10 - 11 - 12 13 - 14 - 15 16 - 17 - 18 19 - 21 - 22 23 - 24 - 26 27 - 28 - 30 32	1/2" T Kol Adaptör Sliding T Handle Adapter		
		1/2" Ara Kol Extension Bar 125 mm		
		1/2" Ara Kol Extension Bar 250 mm		690,95

1114

1/2" On İki Köşe Lokma Anahtar Takımı (24 Parça, mm)
Socket Wrench Set 12 Points (24 pcs, mm)

1/2"

KOD CODE	LOKMALAR Sockets	AVADANLIKLAR Accessories	g	TL/Ad.
1114 00 6024		1/2" Cırcır Kolu Ratchet Handle	4150	24
		1/2" Mafsal Universal Joint		
	10 - 11 - 12 13 - 14 - 15 16 - 17 - 18 19 - 21 - 22 23 - 24 - 26 27 - 28 - 30 32	1/2" T Kol Adaptör Sliding T Handle Adapter		
		1/2" Ara Kol Extension Bar 125 mm		
		1/2" Ara Kol Extension Bar 250 mm		717,75

1413

1/2" On İki Köşe Lokma Anahtar Takımı (24 parça, SAE)
Socket Wrench Set 12 Points (24 pcs, SAE)

1/2"

KOD CODE	LOKMALAR Sockets	AVADANLIKLAR Accessories	g	TL/Ad.
1413 00 6024		1/2" Cırcır Kolu Ratchet Handle	4150	24
		1/2" Mafsal Universal Joint		
	5/16" - 3/8" 7/16" - 15/32" 1/2" - 9/16" 19/32" - 5/8" 11/16" - 3/4" 25/32" - 13/16" 7/8" - 15/16" 1" - 1 1/16" 1 1/8" - 1 3/16" 1 1/4"	1/2" T Kol Adaptör Sliding T Handle Adapter		
		1/2" Ara Kol Extension Bar 125 mm		
		1/2" Ara Kol Extension Bar 250 mm		766,75

1113

1/2" Manyetik Lokma (mm)
Socket Wrench 6 Points (mm)

TS ISO 2725 -1
DIN 3124

1/2"

Krom vanadyum, Krom kaplı
Chrom vanadium, Chrom plated

KOD CODE	mm	Ø D1 mm	Ø D2 mm	L mm	g	TL/Ad.
★1113 06 3008	8	13.2	21.8	38	55	10 16,15
★1113 06 3010	10	15	23.3	38	55	10 23,45
★1113 06 3012	12	17.8	23.3	38	60	10 23,45
★1113 06 3014	14	20.4	23.3	38	65	10 28,60

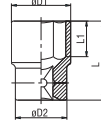
1113

1/2" Manyetik Lokma Allen Uç (mm)
Magnetic Socket Wrench 6 Points (mm) - Hex Bits

1/2"

Krom vanadyum, Krom kaplı
Chrom vanadium, Chrom plated

KOD CODE	ALLEN UÇLAR HEX BITS	Kullanılan Lokma For Dimensions	g	TL/Ad.
★1113 06 3205	5mm	8mm Manyetik Lokma	12	10 8,70
★1113 06 3206	6mm	Manyetik Lokma	139	10 8,70
★1113 06 3207	7mm	Magnetic Socket Wrench	14	10 8,70
★1113 06 3208	8mm		14	10 9,55
★1113 06 3210	10mm	10mm Manyetik Lokma	24	10 9,80
		Magnetic Socket Wrench		
★1113 06 3212	12mm	12mm Manyetik Lokma	37	10 12,60
		Magnetic Socket Wrench		
★1113 06 3214	14mm	14mm Manyetik Lokma	42	10 14,10
		Magnetic Socket Wrench		

3
1113

1/2" Manyetik Lokma Torx® Uç
Magnetic Socket Wrench 6 Points - Torx® Bits

1/2"

Krom vanadyum, Krom kaplı
Chrom vanadium, Chrom plated

KOD CODE	Torx® Uçlar Torx® Bits	Kullanılan Lokma For Dimensions	g	TL/Ad.
★1113 06 3120	T20	8mm Manyetik Lokma Magnetic Socket Wrench	9	10 9,95
★1113 06 3125	T25		9	10 9,95
★1113 06 3127	T27		9	10 9,95
★1113 06 3130	T30		9.4	10 9,95
★1113 06 3140	T40		10.2	10 9,95
★1113 06 3145	T45		11	10 12,10
★1113 06 3150	T50		11.7	10 12,85
★1113 06 3155	T55	10mm Manyetik Lokma Magnetic Socket Wrench	18.2	10 13,85
★1113 06 3160	T60	14mm Manyetik Lokma Magnetic Socket Wrench	31.6	10 15,00

1113

1/2" Manyetik Lokmalı Uç Takımı (20 Parça)
Magnetic Hex Bit Sockets Torx® Bit Sockets Set (20 Pcs)

1/2"

KOD CODE	İÇERİK CONTENTS	TL/Ad.
★1113 00 3020	Manyetik Lokma (1/2") Magnetic Socket Wrench 8 - 10 - 12 - 14 Allen Uç Hex Bit Socket 5 - 6 - 7 - 8 - 10 - 12 - 14 Torx® Uç / Torx® Bits T20 - T25 - T27 - T30 - T40 T45 - T50 - T55 - T60	267,35
	20	

Havali aletler ile kullanmayınız / Do not use with power-tools

(★) İşaretili olan ürünler stoklarla sınırlıdır.
Limited with stocks.

1119

3/4" Altı Köşe Lokma Anahtar (mm)
Socket Wrench 6 Points (mm)

TS ISO 2725 -1
DIN 3124

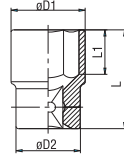

3/4"
Krom vanadyum, Krom kaplı
Chrom vanadium, Chrom plated

KOD CODE	mm	ø D1 mm	ø D2 mm	L mm	L1 mm	g	TL/Ad.
1119 06 1022	22	33	36	52	16	225	5 39,60
1119 06 1024	24	35	36	52	16	230	5 39,60
1119 06 1027	27	38	36	52	19	235	5 40,90
1119 06 1030	30	42	38	54	21	300	5 44,05
1119 06 1032	32	44	38	56	23	320	5 45,85
1119 06 1034	34	47	42	58	24	400	5 60,50
1119 06 1036	36	50	42	58	25	440	5 60,50
1119 06 1038	38	52	45	60	27	500	5 60,50
1119 06 1041	41	56	45	64	29	580	1 89,00
1119 06 1046	46	62	48	68	33	730	1 94,70
1119 06 1050	50	68	48	72	34	885	1 113,75
1119 06 1055	55	76	48	76	37	1070	1 144,85
1119 06 1060	60	80	48	78	38	1170	1 173,00

1120

3/4" On İki Köşe Lokma Anahtar (mm)
Socket Wrench 12 Points (mm)

TS ISO 2725 - 1
DIN 3124

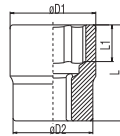

3/4"
Krom vanadyum, Krom kaplı
Chrom vanadium, Chrom plated

KOD CODE	mm	ø D1 mm	ø D2 mm	L mm	L1 mm	g	TL/Ad.
1120 06 1022	22	33	36	52	16	220	5 41,85
1120 06 1024	24	35	36	52	17	225	5 41,85
1120 06 1027	27	38	36	52	19	225	5 43,15
1120 06 1030	30	42	38	54	21	285	5 46,50
1120 06 1032	32	44	38	56	23	310	5 48,65
1120 06 1034	34	47	42	57	24	385	5 64,00
1120 06 1036	36	50	42	58	25	435	5 64,00
1120 06 1041	41	56	45	64	29	560	1 94,45
1120 06 1046	46	62	47	68	34	685	1 100,45
1120 06 1050	50	68	48	72	34	840	1 120,25

1419

3/4" On İki Köşe Lokma Anahtar (SAE)
Socket Wrench 12 Points (SAE)

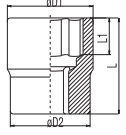

3/4"

Krom vanadyum, Krom kaplı
Chrom vanadium, Chrom plated

KOD CODE	inch	ø D1 mm	ø D2 mm	L mm	L1 mm	g	TL/Ad.
1419 06 1022	7/8"	33	36	52	16	220	5 54,35
1419 06 1024	15/16"	35	36	52	16	220	5 54,35
1419 06 1025	1"	35	36	52	17	220	5 54,60
1419 06 1027	1 1/16"	38	36	52	19	225	5 55,95
1419 06 1028	1 1/8"	40	38	52	19	225	5 55,95
1419 06 1032	1 1/4"	44	38	56	23	315	5 62,90
1419 06 1033	1 5/16"	46	38	56	23	355	5 78,20
1419 06 1035	1 3/8"	48	42	58	25	400	5 78,20
1419 06 1036	1 7/16"	50	42	58	25	425	5 82,00
1419 06 1038	1 1/2"	52	45	60	27	475	5 82,00
1419 06 1041	1 5/8"	56	45	64	29	555	1 121,45
1419 06 1044	1 3/4"	60	47	66	31	660	1 128,25
1419 06 1046	1 13/16"	62	47	68	34	685	1 129,10
1419 06 1047	1 7/8"	64	48	70	34	730	1 154,85
1419 06 1050	2"	68	48	72	34	805	1 155,95

1519

3/4" Cırcır Kolu
Ratchet Handle

TS ISO 3315
DIN 3122



3/4"

Krom vanadyum, Krom kaplı
Chrom vanadium, Chrom plated

KOD CODE	L mm	g	TL/Ad.
1519 06 4510	510	2230	5 385,65

1519

3/4" Ara Kol
Extension Bar

TS ISO 1174
DIN 3123



3/4"

Krom vanadyum, Krom kaplı
Chrom vanadium, Chrom plated

KOD CODE	L mm	g	TL/Ad.
1519 06 4200	200	730	5 113,25
1519 06 4400	400	1370	5 205,20

1519

3/4" T Kol
Sliding T - Handle

TS ISO 3315
DIN 3122

3/4"

Krom vanadyum, Krom kaplı
Chrom vanadium, Chrom plated

KOD CODE	L mm	g		TL/Ad.
1519 06 4500	500	1485	5	228,35

1519

3/4" Lokma Adaptörü
Adapter

TS ISO 1174
DIN 3123

3/4"

Krom vanadyum, Krom kaplı
Chrom vanadium, Chrom plated

KOD CODE	inch	g		TL/Ad.
1519 06 0008	3/4"Fx1/2"M	140	5	48,55
1519 06 0001	3/4"Fx1"M	300	5	65,65

1119

3/4" Altı Köşe Lokma Anahtar Takımı (14 parça, mm)
Socket Wrench Set 6 Points (14 pcs, mm)

3/4"

KOD CODE	LOKMALAR Sockets	AVADANLIKLAR Accessories	g		TL/Ad.
1119 00 6114	22 - 24 - 27 30 - 32 - 34 36 - 41 - 46 50	3/4" Cırcır Kolu Ratchet Handle	10180	14	1560,90
		3/4" T Kol Sliding T Handle			
		3/4" Ara Kol Extension Bar 200 mm			
		3/4" Ara Kol Extension Bar 400 mm			

1120

3/4" On İki Köşe Lokma Anahtar Takımı (14 parça, mm)
Socket Wrench Set 12 Points (14 pcs, mm)

3/4"

KOD CODE	LOKMALAR Sockets	AVADANLIKLAR Accessories	g		TL/Ad.
1120 00 6014	22 - 24 - 27 30 - 32 - 34 36 - 41 - 46 50	3/4" Cırcır Kolu Ratchet Handle	13700	14	1597,60
		3/4" T Kol Sliding T Handle			
		3/4" Ara Kol Extension Bar 200 mm			
		3/4" Ara Kol Extension Bar 400 mm			

1419

3/4" On İki Köşe Lokma Takımı (14 parça, SAE)
Socket Wrench Set 12 Points (14 pcs, SAE)



3/4"

KOD CODE	LOKMALAR Sockets	AVADANLIKLAR Accessories	g		TL/Ad.
1419 00 6114	15/16" - 1 1/6" 1 1/8" - 1 1/4" 1 5/16" 1 3/8" 1 1/2" - 1 5/8" 1 7/8" - 2"	3/4" Cırcır Kolu Ratchet Handle	10180	14	1832,25
		3/4" T Kol Sliding T Handle			
		3/4" Ara Kol Extension Bar 200 mm			
		3/4" Ara Kol Extension Bar 400 mm			

1225

1" On İki Köşe Lokma Anahtar (mm)
Socket Wrench 12 Points (mm)

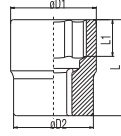
DIN 3124



1"

Krom vanadyum, Krom kaplı
Chrom vanadium, Chrom plated

KOD CODE	Ø mm	Ø D1 mm	Ø D2 mm	L mm	L1 mm	g	TL/Ad.
1225 06 0036	36	52	48	65	26	525	1 129,65
1225 06 0041	41	58	50	70	29	665	1 141,15
1225 06 0046	46	65	54	75	32	900	1 171,15
1225 06 0050	50	70	57	75	34	1040	1 202,75
1225 06 0055	55	76	57	83	42	1250	1 260,55
1225 06 0060	60	82	60	87	46	1505	1 337,50

1525

1" Lokma Adaptörü
Adapter

TS ISO 1174
DIN 3123



1"

Krom vanadyum, Krom kaplı
Chrom vanadium, Chrom plated

KOD CODE	inch	g	TL/Ad.
1525 06 0005	1"Fx3/4"M	330	5 93,70

1113

1/2" Alaşımli Jant Lokma Takımı (3 Parca, mm)
Combination Lug Nut Socket Set (3 Pcs, mm)



1/2"

KOD CODE	LOKMALAR Sockets	g	TL/Ad.
1113 00 9003	17-19-21	800	3 266,15

1113

1/2" Alaşımli Jant Lokma Takımı (7 Parca, mm)
Combination Lug Nut Socket Set (7 Pcs, mm)



1/2"

KOD CODE	LOKMALAR Sockets	g	TL/Ad.
★1113 00 9007	17 - 19 - 21 - 22 23 - 24 - 27	2250	7 480,45

1113

1/2" Altı Köşe Havalı Lokma Anahtar (mm) Impact Socket Wrench 6 Points (mm)

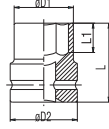

1/2"

Krom molibden, Fosfat kaplamalı
Chrom molybdenum, Phosphate finish

KOD CODE	mm	Ø D1 mm	Ø D2 mm	L mm	L1 mm	g	TL/Ad.
1113 06 7010	10	17	25	38	8	70	10
1113 06 7011	11	18	25	38	8	70	10
1113 06 7012	12	19	25	38	9	70	10
1113 06 7013	13	20	25	38	10	70	10
1113 06 7014	14	22	25	38	10	75	10
1113 06 7015	15	23	30	38	11	110	10
1113 06 7016	16	24	30	38	11	110	10
1113 06 7017	17	26	30	38	12	115	10
1113 06 7018	18	27	30	38	13	115	10
1113 06 7019	19	28	30	38	13	120	10
1113 06 7021	21	30	30	40	14	125	5
1113 06 7022	22	32	30	40	14	145	5
1113 06 7024	24	34	30	42	15	150	5
1113 06 7027	27	38	30	44	16	175	5

1513

1/2" Havalı Lokma Ara Kol Impact Socket Extension Bar



1/2"

Krom molibden, Fosfat kaplamalı
Chrom molybdenum, Phosphate finish

KOD CODE	L mm	g	TL/Ad.
1513 06 7125	125	275	5
★1513 06 7250	250	450	5

1108

1/2" Altı Köşe Havalı Derin Lokma Anahtar (mm) 6 Point Impact Socket Wrench, Long Type (mm)



1/2"



Krom molibden, Fosfat kaplamalı
Chrom molybdenum, Phosphate finish

3

KOD CODE	mm	L mm	g	TL/Ad.
1108 06 7010	10	80	136	10
1108 06 7011	11	80	144	10
1108 06 7012	12	80	157	10
1108 06 7013	13	80	157	10
1108 06 7014	14	80	172	10
1108 06 7015	15	80	223	10
1108 06 7016	16	80	230	10
1108 06 7017	17	80	240	10
1108 06 7018	18	80	255	10
1108 06 7019	19	80	236	10
1108 06 7021	21	80	240	10
1108 06 7022	22	80	296	5
1108 06 7024	24	80	308	5
1108 06 7027	27	80	356	5
1108 06 7030	30	80	416	5
1108 06 7032	32	80	510	5

1513

1/2" Havalı Lokma Adaptörü Impact Socket Adapter



Krom molibden, Fosfat kaplamalı
Chrom molybdenum, Phosphate finish

1/2"

KOD CODE	inch	g	TL/Ad.
1513 06 7002	1/2"Fx3/8"M	95	5
1513 06 7003	1/2"Fx3/4"M	175	5

1513

1/2" Havalı Lokma Mafsal Impact Socket Universal Joint



Krom molibden, Fosfat kaplamalı
Chrom molybdenum, Phosphate finish

1/2"

KOD CODE	L mm	g	TL/Ad.
1513 06 7075	75	220	5

1119

3/4" Altı Köşe Havalı Lokma Anahtar (mm)
Impact Socket Wrench 6 Points (mm)



3

3/4"

Krom molibden, Fosfat kaplamalı
Chrom molybdenum, Phosphate finish

KOD CODE	mm	β D1 mm	β D2 mm	L mm	L1 mm	g	TL/Ad.
1119 06 7019	19	32	44	50	13	330	58,05
1119 06 7021	21	35	44	50	15	340	58,05
1119 06 7022	22	36	44	50	15	345	58,05
1119 06 7024	24	38	44	50	16	350	58,05
1119 06 7027	27	42	44	53	17	380	59,70
1119 06 7030	30	46	44	53	20	410	64,35
1119 06 7032	32	48	44	57	20	460	64,35
1119 06 7034	34	51	44	57	22	490	83,95
1119 06 7036	36	53	44	57	22	520	83,95
1119 06 7041	41	59	44	58	24	580	129,55
1119 06 7046	46	66	44	62	24	715	137,70

1519

3/4" Havalı Lokma Ara Kol
Impact Socket Extension Bar



3/4"

Krom molibden, Fosfat kaplamalı
Chrom molybdenum, Phosphate finish

KOD CODE	L mm	g	TL/Ad.
1519 06 7175	175	865	177,35
1519 06 7250	250	1155	253,60
1519 06 7330	330	1425	384,85

1519

3/4" Havalı Lokma Mafsal
Impact Socket Universal Joint



3/4"

Krom molibden, Fosfat kaplamalı
Chrom molybdenum, Phosphate finish

KOD CODE	L mm	g	TL/Ad.
1519 06 7108	108	735	295,40

1519

3/4" Havalı Lokma Adaptörü
Impact Socket Adapter



3/4"

Krom molibden, Fosfat kaplamalı
Chrom molybdenum, Phosphate finish

KOD CODE	inch	g	TL/Ad.
1519 06 7011	3/4"Fx1/2"M	315	78,70

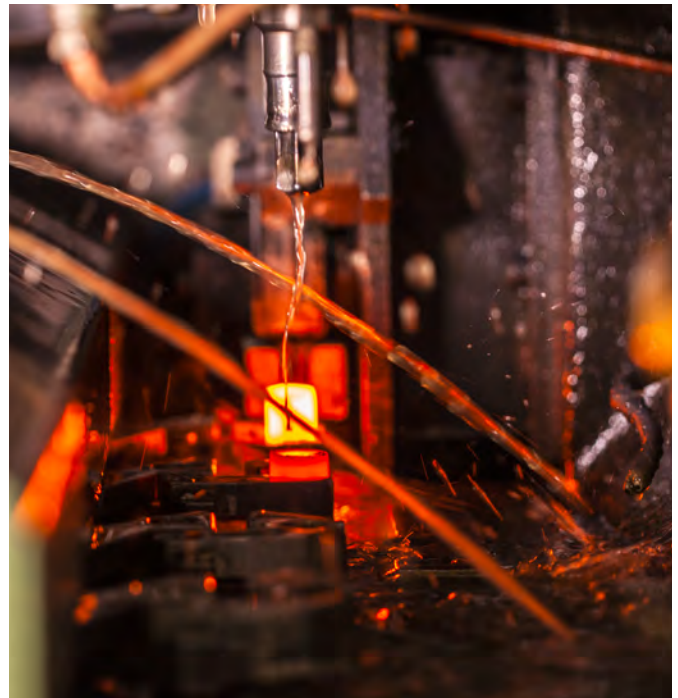

1125

1" Altı Köşe Havalı Lokma Anahtar (mm) Impact Socket Wrench 6 Points (mm)



1"



Krom molibden, Fosfat kaplamalı
Chrom molybdenum, Phosphate finish

KOD CODE	mm	β D1 mm	β D2 mm	L mm	L1 mm	g		TL/Ad.
1125 06 7024	24	41	54	58	17	560	1	109,35
1125 06 7027	27	44	54	58	19	565	1	110,35
1125 06 7030	30	48	54	60	21	605	1	111,25
1125 06 7032	32	51	54	62	21	650	1	112,55
1125 06 7033	33	52	54	62	21	660	1	112,55
1125 06 7034	34	53	54	62	24	765	1	113,15
1125 06 7036	36	56	54	65	24	720	1	113,70
1125 06 7038	38	58	54	65	26	735	1	118,40
1125 06 7041	41	61	54	70	28	845	1	127,00
1125 06 7046	46	68	54	75	30	1075	1	145,95
1125 06 7050	50	73	54	75	32	1170	1	162,40
1125 06 7055	55	79	54	83	37	1435	1	225,15
1125 06 7060	60	86	54	87	37	1760	1	281,45

1525

1" Havalı Lokma Mafsal Impact Socket Universal Joint



3

1"

Krom molibden, Fosfat kaplamalı
Chrom molybdenum, Phosphate finish

KOD CODE	L mm	g		TL/Ad.
1525 06 7128	128	1530	1	603,20

1525

1" Havalı Lokma Ara Kol Impact Socket Extension Bar



1"

Krom molibden, Fosfat kaplamalı
Chrom molybdenum, Phosphate finish

KOD CODE	L mm	g		TL/Ad.
1525 06 7175	175	1395	5	322,75
1525 06 7250	250	1890	5	415,05
1525 06 7330	330	2455	5	503,90

1525

1" Havalı Lokma Adaptörü Impact Socket Adapter



1"

Krom molibden, Fosfat kaplamalı
Chrom molybdenum, Phosphate finish

KOD CODE	inch	g		TL/Ad.
1525 06 7015	1"Fx3/4"M	560	5	123,70



1800

Kovan Anahtar İki Ağz (mm)
Double Ended Tubular Socket Wrench (mm)

TS ISO 3793
DIN 896

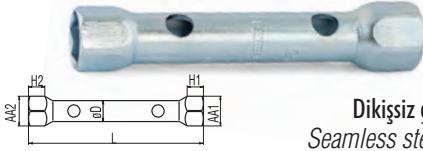

Dikişsiz çelik boru, Çinko kaplı
Seamless steel tube, Zinc plated

3

KOD CODE	mm	L mm	AA1 mm	AA2 mm	H1 mm	H2 mm	g	TL/Ad.	
1800 07 0607	6x7	105	8.6	9.6	7	8	25	5	19,75
1800 07 0809	8x9	105	11.2	12.2	9	10	35	5	21,70
1800 07 1011	10x11	120	13.6	14.6	11	11.5	55	5	29,80
1800 07 1213	12x13	135	16	17	12	12.5	80	5	31,60
1800 07 1415	14x15	135	18.5	19.5	13	13.5	110	5	34,65
1800 07 1617	16x17	150	21	22	14	14.5	150	5	37,20
1800 07 1819	18x19	150	23	24	15	15.5	170	5	38,55
1800 07 2022	20x22	165	25.4	27.4	16	18	220	5	42,50
★1800 07 2123	21x23	165	26.4	28.4	17	19	240	5	45,80
1800 07 2224	22x24	180	27.4	29.4	18	20	330	5	47,70
★1800 07 2426	24x26	180	30.4	32.4	20	22	340	5	59,40
1800 07 2427	24x27	180	30.4	33.4	20	23	400	5	61,70
★1800 07 2528	25x28	200	31.4	34.4	21	24	400	5	69,95
★1800 07 2732	27x32	200	33.4	38.4	23	26	435	5	81,35

1800

Kovan Anahtar Takımı İki Ağz (mil dahil, mm)
Double Ended Tubular Socket Wrench Set with Tommy Bars (mm)



KOD CODE	mm	g	TL/Ad.	
1800 00 2108	6x7 - 8x9 - 10x11 - 12x13 - 14x15 16x17 - 18x19 - 20x22 Mil/Handle Bars 5x125-8x180 mm	920	10	276,40

1841

Kovan Anahtar Bir Ağz (mil dahil)
Single Ended Tubular Socket Wrench with Tommy Bar



Dikişsiz çelik boru, Çinko kaplı
Seamless steel tube, Zinc plated

KOD CODE	mm		L mm	σD mm	Mil Handle bar mm	g	TL/Ad.	
	mm	inch						
1841 07 0021	21	13/16"	120	20	10x120	215	5	33,40

1850

Kovan Anahtar Mili
Tommy Bar

TS ISO 3793
DIN 900



KOD CODE	σDxL mm	g	TL/Ad.	
1850 07 5125	5x125	20	10	8,15
1850 07 8180	8x180	70	10	12,50
1850 07 1120	10x120	75	10	14,15
1850 07 1200	10x200	120	10	16,00

1870

Ağır Tip Bijon Anahtarı İki Ağz Uzun
Double Ended Rim Wrench (long)

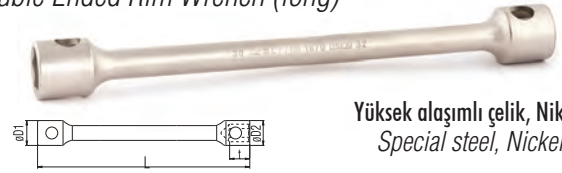

Yüksek alaşımli çelik, Nikel kaplı
Special steel, Nickel plated

KOD CODE	mm	L mm	t mm	σD1 mm	σD2 mm	g	TL/Ad.	
1870 09 2427	24x27	400	34.5	36	40	1135	10	88,10
1870 09 2730	27x30	400	34.5	40	44	1380	10	101,20
1870 09 2732	27x32	400	34.5	40	46	1380	10	101,20
1870 09 3032	30x32	400	34.5	44	46	1380	10	104,75
1870 09 3233	32x33	400	34.5	46	47	1450	10	116,25

1874

Ağır Tip Bijon Anahtarı İki Ağz Kısa
Double Ended Rim Wrench (short)

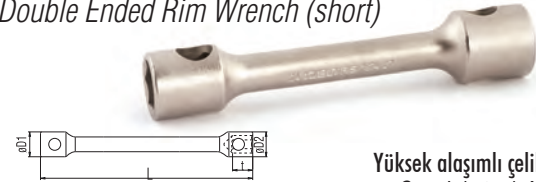

Yüksek alaşımli çelik, Nikel kaplı
Special steel, Nickel plated

KOD CODE	mm	L mm	t mm	σD1 mm	σD2 mm	g	TL/Ad.	
1874 09 2224	22x24	170	34.5	34	36	720	10	55,80
1874 09 2427	24x27	200	34.5	36	40	800	10	71,35

1850

Bijon Anahtar Mili
Tommy Bar

TS ISO 3793
DIN 900



KOD CODE	σDxL mm	g	TL/Ad.	
1850 09 1630	18x630	1260	1	51,25

1975

Bijon Anahtarı İstavroz Tipi Cross Rim Wrench

TS ISO 6788



Yüksek alaşımlı çelik, Krom kaplı
Special steel, Chrom plated

KOD CODE	mm	inch	øD mm	h mm	L mm	ød mm	g	TL/Ad.
	17	11/16"	28	12				
1975 09 1719	19	3/4"	30	14	420	16	1422	10 105,30
	21	13/16"	32	16				
	22	7/8"	34	17				

1975

1/2" Adaptörlü Bijon Anahtarı İstavroz Tipi Cross Rim Wrench (with 1/2" adapter)

TS ISO 6788

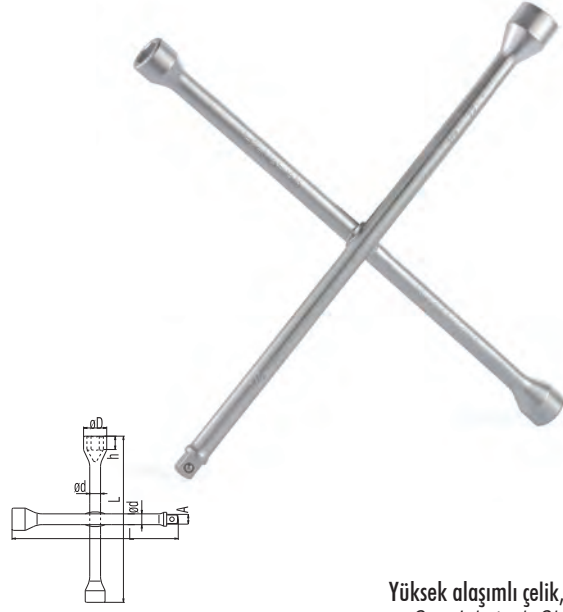

Yüksek alaşımlı çelik, Krom kaplı
Special steel, Chrom plated

KOD CODE	mm	inch	øD mm	h mm	L mm	A mm	ød mm	g	TL/Ad.
	17	11/16"	28	12					
1975 09 1322	19	3/4"	30	14	420	12.65	16	1375	10 107,20
	22	7/8"	34	17					
		1/2"							

1940

Bijon Anahtarı Pipo Tipi (Tornavida Ağzılı) Offset Socket Wrench with Screwdriver

TSEK

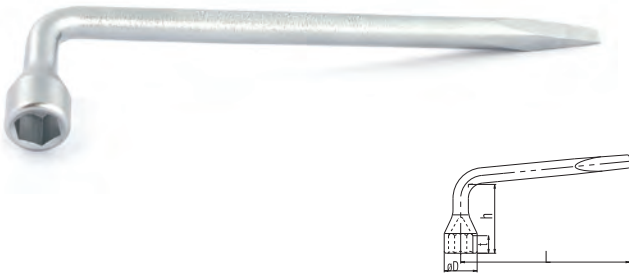

Yüksek alaşımlı çelik, Krom kaplı
Special steel, Chrom plated

KOD CODE	mm	inch	L mm	øD mm	h mm	g	TL/Ad.
1940 09 0017	17	11/16"	285	28	65	485	10 35,25
1940 09 0019	19	3/4"	285	30	65	470	10 42,30
1940 09 0021	21	13/16"	320	32	85	575	10 52,30



1840

1/2" Mafsallı T Kol
Swivel Handle With Sliding T 1/2"



1845

Mafsallı Buji Lokma
Spark Plug Wrench with Universal Joint



1/2"

Özel alaşım çelik, Krom kaplı
Special steel, Chrom plated

KOD CODE	mm	L mm	g	TL/Ad.
1840 08 0500	1/2"	500	740	10 197,20

Özel alaşım çelik, Krom kaplı
Special steel, Chrom plated

KOD CODE	mm	L mm	g	TL/Ad.
★1845 08 0160	16	500	525	10 265,35
★1845 08 0208	20.8	520	960	10 322,90

1855

Mafsallı T Kol Lokma
T - Handle Wrench with Universal Joint



Özel alaşım çelik, Krom kaplı
Special steel, Chrom plated

KOD CODE	mm	L mm	g	TL/Ad.
1855 08 0008	8	400	225	10 198,00
1855 08 0010	10	450	405	10 249,00
1855 08 0012	12	450	410	10 249,00
1855 08 0013	13	450	425	10 249,00
1855 08 0017	17	500	485	10 277,40
1855 08 0019	19	510	895	10 352,60

1857

T Kol Lokma
T - Handle Hexagonal Socket Wrench



Özel alaşım çelik, Krom kaplı
Special steel, Chrom plated

KOD CODE	mm	L mm	g	TL/Ad.
★1857 08 0013	13	260	315	10 109,20
★1857 08 0017	17	280	470	10 139,75

1610

3/8" Tork Anahtarı
Torque Wrench

TS EN ISO 6789-1
TS EN ISO 6789-2

3/8"

KOD CODE	ÖLÇÜ SIZE	L mm	g	TL/Ad.
1610 06 0100	2.5 - 11 Nm - 0.3 - 1.2 Kg	350	515	1 1001,05
1610 06 0300	7 - 33 Nm - 0.5 - 3.4 Kg	450	640	1 1034,95

1613

1/2" Tork Anahtarı
Torque Wrench

TS EN ISO 6789-1
TS EN ISO 6789-2

1/2"

KOD CODE	ÖLÇÜ SIZE	L mm	g	TL/Ad.
1613 06 1200	25 - 135 Nm - 3 - 14 Kg	550	1430	1 1068,80
1613 06 2000	50 - 225 Nm - 5 - 23 Kg	600	2165	1 1103,20
1613 06 3000	70 - 330 Nm - 7 - 35 Kg	800	2870	1 1342,40

1619

3/4" Tork Anahtarı
Torque Wrench

TS EN ISO 6789-1
TS EN ISO 6789-2

3/4"

KOD CODE	ÖLÇÜ SIZE	L mm	g	TL/Ad.
1619 06 2080	200 - 800 Nm-22-82 kg	1050	8860	1 4136,90

1607

1/4" Cırcırlı Tork Anahtar
Torque Wrench With Reversible Ratchet-Head

TS EN ISO 6789-1
TS EN ISO 6789-2

1/4"

KOD CODE	ÖLÇÜ SIZE	L mm	g	TL/Ad.
1607 06 0420	4 - 20 Nm	320	640	1 792,40

1610

3/8" Cırcırlı Tork Anahtar
Torque Wrench With Reversible Ratchet-Head

TS EN ISO 6789-1
TS EN ISO 6789-2

3/8"

KOD CODE	ÖLÇÜ SIZE	L mm	g	TL/Ad.
1610 06 2010	20 -100 Nm	435	1300	1 894,65

1613

1/2" Cırcırlı Tork Anahtar
Torque Wrench With Reversible Ratchet-Head

TS EN ISO 6789-1
TS EN ISO 6789-2

1/2"

KOD CODE	ÖLÇÜ SIZE	L mm	g	TL/Ad.
1613 06 4020	40- 200Nm	510	1590	1 917,00
1613 06 6034	60- 340Nm	610	1810	1 961,35

1619

3/4" Cırcırlı Tork Anahtar
Torque Wrench With Reversible Ratchet-Head

TS EN ISO 6789-1
TS EN ISO 6789-2

3/4"

KOD CODE	ÖLÇÜ SIZE	L mm	g	TL/Ad.
1619 06 1060	100-600 Nm	1050	5600	1 2905,95

3

Lokmayı salmayan bilya tasarımı
(kare adaptörlü bilyalı tasarım)
Square adaptor with ball design to
lock sockets

Değiştirilebilir iç mekanizma
Inter-changeable inner mechanism

Yüksek dayanım için
güçlü 32 diş
32 teeth for high
endurance

Çift yönlü kullanım
sağlayan mandal tasarımı
Bi-directional latch design

Yüksek mukavemetli
alaşımli sıcak dövme çeliği
High strength alloyed cold
work tool steel

Nikel üzerine krom
kaplama ile korozyon
direncinde üst seviye koruma
High corrosion resistance with
chrome over nickel plating

Dayanımı yüksek sert plastikten ve
konforlu tutuş sağlayan yumuşak
elastomer malzemeden imal edilmiş çift
komponentli ergonomik sap
Two component ergonomic handle with high
strength and soft grip plastic



IZELTAS®

BORU ANAHTARLARI VE PENSELER

PIPE WRENCHES AND PLIERS

Boru Anahtarları
Pipe Wrenches

Fort Penseler
Water Pump Pliers

Ayarlı Penseler
Grip Wrenches

Penseler
Pliers

Kargaburunlar
Nose Pliers

Kerpetenler
Carpenter Pincers

Elektronikçi Penseler
Electronic Pliers



KOMBİNE PENSE KRAFT SERİ/COMBINATION PLIERS

Güçlü kavrama sağlayan
tırnaklı tutma yüzeyleri
Toothed surface for strong grip

Isıl işlem sonrasında indüksiyonda
sertleştirme ile kullanım ömrü artırılmış
kesici ağızlar
Heat-treated and induction hardened
cutting edges for long lifetime

Nikel üzerine krom kaplama ile
korozyon direncinde
üst seviye koruma
High corrosion resistance with chrome
over nickel plating

Yüksek karbonlu
sıcak dövme
çeliği ile artırılmış
dayanım
High carbon forged
steel for improved
durability

Düşmelere ve darbeye dayanıklı,
selüloz asetat ergonomik sap
Impact resistant cellulose acetate
handle

2100

Stilson Boru Anahtarı Pipe Wrench, Stilson



Yedek parça sayfa 196
Spare parts page 196

Krom vanadyum, Dişler indüksiyonda sertleştirilmiş, Elektrostatik boyanmış
Chrom vanadium, Teeth induction hardened, Electrostatically painted

KOD CODE	L mm	L inch	mm	ÖLÇÜ SIZE Inch	g	TL/Ad.
2100 10 0008	200	8"	27	3/4"	280	112,15
2100 10 0010	250	10"	34	1"	550	144,50
2100 10 0012	300	12"	42	1 1/4"	725	162,60
2100 10 0014	350	14"	50	1 1/2"	1030	186,30
2100 10 0018	450	18"	60	2"	1775	253,40
2100 10 0024	600	24"	76	2 1/2"	2775	408,30

2110

Ağır Tip Boru Anahtarı Pipe Wrench, Heavy Duty



Yedek parça sayfa 196
Spare parts page 196

Krom vanadyum, Dişler indüksiyonda sertleştirilmiş, Elektrostatik boyanmış
Chrom vanadium, Teeth induction hardened, Electrostatically painted

KOD CODE	L mm	L inch	mm	ÖLÇÜ SIZE Inch	g	TL/Ad.
2110 10 0008	200	8"	34	1"	425	145,00
2110 10 0010	250	10"	42	1 1/4"	795	180,00
2110 10 0012	300	12"	50	1 1/2"	1245	206,15
2110 10 0014	350	14"	60	2"	1710	240,00
2110 10 0018	450	18"	75	2 1/2"	2685	334,80
2110 10 0024	600	24"	90	3"	4370	540,00
2110 10 0036	900	36"	140	5"	7600	1196,20
2110 10 0048	1200	48"	165	6"	15600	2450,00

2200

Maşalı Boru Anahtarı (45°) Pipe Wrench (45°)



Krom vanadyum, Dişler indüksiyonda sertleştirilmiş, Elektrostatik boyanmış
Chrom vanadium, Teeth induction hardened, Electrostatically painted

KOD CODE	L mm	mm	ÖLÇÜ SIZE Inch	g	TL/Ad.
★2200 10 0005	255	22	1/2"	385	166,60
★2200 10 0010	335	35	1"	720	197,85
★2200 10 0015	470	46	1 1/2"	1345	279,45
★2200 10 0020	630	65	2"	2470	445,15

2201

Maşalı Boru Anahtarı (85°) Pipe Wrench (85°)



Yedek parça sayfa 196
Spare parts page 196

Krom vanadyum, Dişler indüksiyonda sertleştirilmiş, Elektrostatik boyanmış
Chrom vanadium, Teeth induction hardened, Electrostatically painted

KOD CODE	L mm	mm	ÖLÇÜ SIZE Inch	g	TL/Ad.
2201 10 0010	325	40	1"	870	123,10
2201 10 0015	430	60	1 1/2"	1585	190,70
2201 10 0020	585	70	2"	2700	285,55
2201 10 0030	690	100	3"	4270	432,95
2201 10 0040	760	130	4"	5800	649,35

2202

İsveç Tip Maşalı Boru Anahtarı Pipe Wrench, Swedish Pattern

DIN 5234



Krom vanadyum, Dişler indüksiyonda sertleştirilmiş, Elektrostatik boyanmış
Chrom vanadium, Teeth induction hardened, Electrostatically painted

KOD CODE	L mm	mm	ÖLÇÜ SIZE Inch	g	TL/Ad.
★2202 10 0010	320	40	1"	845	201,20
★2202 10 0015	410	60	1 1/2"	1465	290,90
★2202 10 0020	535	70	2"	2345	448,65

2400

Üniversal Fort Pense
Waterpump Pliers Universal

TSE
TS 60 TS ISO 8976
DIN ISO 8976



Krom vanadyum, Krom kaplı, PVC izoleli
Chrom vanadium, Chrom plated, PVC insulated

KOD CODE	L mm	L inch	mm	g	TL/Ad.
2400 11 0160	160	6 1/4"	30	125	5 78,30
2400 11 0240	240	9 1/2"	35	355	5 100,35
2400 11 0315	315	12 1/2"	40	530	5 179,40

2400

1000V İzoleli Üniversal Fort Pense
Insulated Type Waterpump Pliers Universal 1000V

TSE
TS 60
TS ISO 8976



Krom vanadyum, Krom kaplı, çift komponent saplı
Chrom vanadium, Chrom plated, Two component handle

KOD CODE	L mm	L inch	mm	g	TL/Ad.
2400 11 6240	240	9 1/2"	35	370	5 116,45

2415

Yaylı Fort Pense
Waterpump Pliers With Spring



Krom vanadyum, Karartma, PVC izoleli
Chrom vanadium, Black finish, PVC insulated

KOD CODE	L mm	L inch	mm	g	TL/Ad.
2415 11 0240	240	6 1/4"	35	365	5 135,45

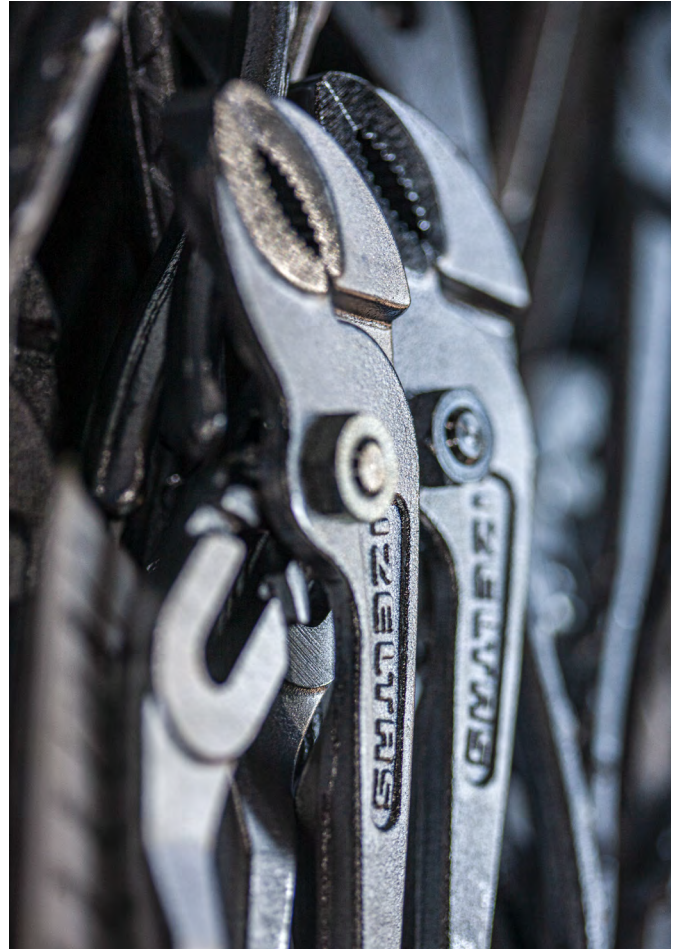

2500
Üniversal Ayarlı Pense
Universal Grip

Çeneler krom vanadyum çeliğinden dövülmüştür, Nikel kaplama,
 Kullanım sahası: Yuvarlak ve düz malzemeler
Jaws Chrom vanadium forged, Nickel plated
 Application field : Flat and round materials

KOD CODE	L mm	L inch	mm	g	TL/Ad.
2500 11 0250	250	10"	30	560	5 122,85

2510
Spesiyal Ayarlı Pense
Special Grip

Çeneler krom vanadyum çeliğinden dövülmüştür, Nikel kaplama,
 Kullanım sahası: Yuvarlak ve düz malzemeler
Jaws Chrom vanadium forged, Nickel plated
 Application field: Flat and round materials

KOD CODE	L mm	L inch	mm	g	TL/Ad.
2510 11 0250	250	10"	30	550	5 122,85

4
2505
Standart Ayarlı Pense
Standard Grip
TSEK

Çeneler krom vanadyum çeliğinden dövülmüştür, Nikel kaplama
 Kullanım sahası: Düz malzemeler
Jaws, Chrom vanadium forged, Nickel plated
 Application field: Flat materials

KOD CODE	L mm	L inch	mm	g	TL/Ad.
2505 11 0250	250	10"	30	535	5 122,85

2511
C tipi Ayarlı Pense
Clamp Grip C-type

Çeneler krom vanadyum çeliğinden dövülmüştür, Nikel kaplama,
 Kullanım sahası: Açılı profillerin tutulmasında
Jaws Chrom vanadium forged, Nickel plated
 Application field: For Gripping angled sheet metal

KOD CODE	L mm	L inch	mm	g	TL/Ad.
2511 11 0280	280	11"	70	700	1 179,75

2512**Kaynakçı Ayarlı Pense (Düz Ağız)**
Lock Grip With Flat Jaws**2515****Kaportacı Ayarlı Pense**
Welding Grip**4**

Özel alaşımlı çelikten imal edilmiş, Nikel kaplama,
Kullanım sahası: 80 mm düz çeneleri ile kıvrık metal levhaları
Made from special alloy steel, Nickel plated, Application field:
Gripping sheet metals with 80 mm Flat jaws

KOD CODE	L mm	L inch				TL/Ad.
2512 11 0200	200	8"	30	485	1	181,40

Özel alaşımlı çelikten imal edilmiş- Nikel kaplama,
Kullanım sahası: Yassı ve köşeli malzemelerde
Made from special alloy steel, Nickel plated
Application field : Angled corners and edges

KOD CODE	L mm	L inch				TL/Ad.
2515 11 0270	270	10 5/8"	50	765	1	164,55

2513**Kaynakçı Ayarlı Pense (Boru İçin)**
Grip For Tubes

Özel alaşımlı çelikten imal edilmiş, Nikel kaplama,
Kullanım sahası: Boru malzemeler
Made from special alloy steel, Nickel plated, Application field: Tubes

KOD CODE	L mm	L inch				TL/Ad.
2513 11 0280	280	11"	50	800	1	181,40

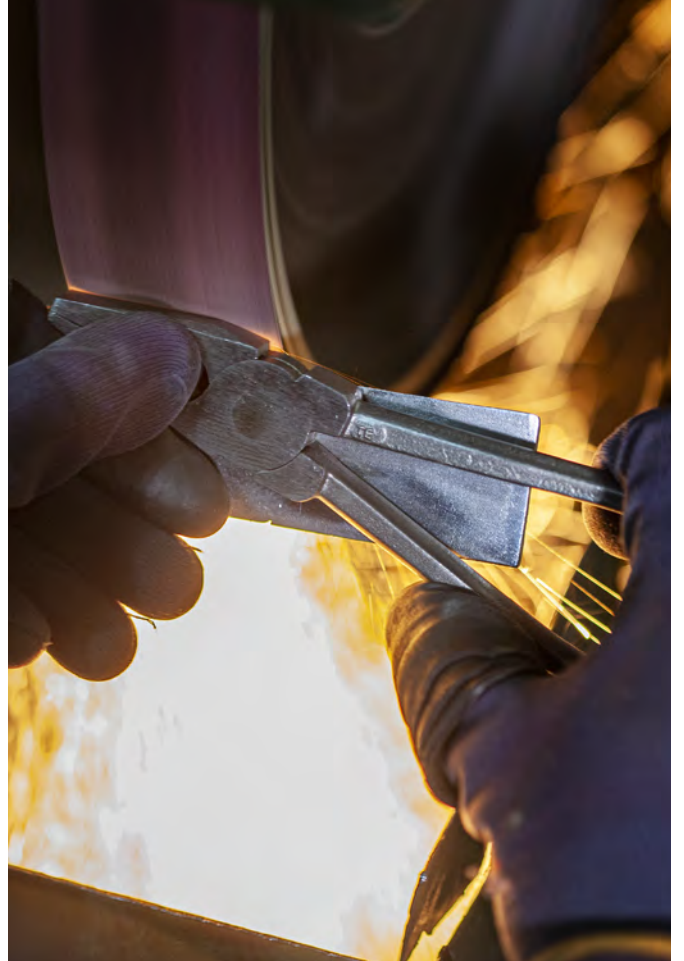

3020

Kombine Pense Opak Seri Combination Pliers

TS 60
TS ISO 5746
DIN ISO 5746



Özel alaşımli çelik, Kesici ağızlar indüksiyonda sertleştirilmiş
Special steel, Cutters induction hardened

KOD CODE	L mm	L inch	MODEL	g	TL/Ad.
3020 12 2160	160	6 1/4"	OPAK	205	5 68,00
3020 12 2180	180	7 1/8"	OPAK	275	5 77,20
3020 12 2200	200	8"	OPAK	315	5 87,15

3020

Kombine Pense Kraft Seri Combination Pliers

TS 60
TS ISO 5746
DIN ISO 5746



Özel alaşımli çelik, Kesici ağızlar indüksiyonda sertleştirilmiş
Special steel, Cutters induction hardened

KOD CODE	L mm	L inch	MODEL	g	TL/Ad.
3020 12 3160	160	6 1/4"	KRAFT	225	5 83,40
3020 12 3180	180	7 1/8"	KRAFT	285	5 93,15
3020 12 3200	200	8"	KRAFT	380	5 105,25

3020

Kombine Pense Ergonomik Seri Combination Pliers

TS 60
TS ISO 5746
DIN ISO 5746



Özel alaşımli çelik, Kesici ağızlar indüksiyonda sertleştirilmiş
Special steel, Cutters induction hardened

KOD CODE	L mm	L inch	MODEL	g	TL/Ad.
3020 12 5160	160	6 1/4"	ERGONOMİK	205	5 85,55
3020 12 5180	180	7 1/8"	ERGONOMİK	260	5 97,20
3020 12 5200	200	8"	ERGONOMİK	345	5 109,75

3020

1000V İzoleli Elektrikçi Kombine Pense Electrician Type Insulated Combination Pliers 1000V



TS 60
TS ISO 5746
DIN ISO 5746



1000 V
IEC 60900



Özel alaşımli çelik, Kesici ağızlar indüksiyonda sertleştirilmiş, Krom kaplı
Special steel, Cutters induction hardened, Chrom plated

KOD CODE	L mm	L inch	MODEL	g	TL/Ad.
3020 12 6160	160	6 1/4"	1000V	205	5 93,70
3020 12 6180	180	7 1/8"	1000V	260	5 100,30
3020 12 6200	200	8"	1000V	345	5 113,25

3030

Kombine Pense Ağır Tip (çelik tel için) Combination Pliers Heavy Duty (for piano wire)

R&D
AR-GE



Özel alaşımli çelik, Kesici ağızlar indüksiyonda sertleştirilmiş
Special steel, Cutters induction hardened

KOD CODE	L mm	L inch	MODEL	g	TL/Ad.
3030 12 2180	180	7 1/8"		285	5 102,40
3030 12 2200	200	8"		380	5 117,10

3220

Kargaburun Düz Uçlu Opak Seri
Long Nose Pliers (Flat)

TS 60 - TS ISO 5745
DIN ISO 5745



4

Özel alaşımli çelik, Kesici ağızlar indüksiyonda sertleştirilmiş
Special steel, Cutters induction hardened

KOD CODE	L mm	L inch	MODEL	g	TL/Ad.
3220 13 2140	140	5 1/2"	OPAK	110	5 70,20
3220 13 2160	160	6 1/4"	OPAK	135	5 79,35
3220 13 2180	180	7 1/8"	OPAK	170	5 87,20
3220 13 2200	200	8"	OPAK	205	5 92,50

3220

Kargaburun Düz Uçlu Kraft Seri
Long Nose Pliers (Flat)

TS 60 - TS ISO 5745
DIN ISO 5745



Özel alaşımli çelik, Kesici ağızlar indüksiyonda sertleştirilmiş
Special steel, Cutters induction hardened

KOD CODE	L mm	L inch	MODEL	g	TL/Ad.
3220 13 3140	140	5 1/2"	KRAFT	120	5 86,70
3220 13 3160	160	6 1/4"	KRAFT	155	5 97,85
3220 13 3180	180	7 1/8"	KRAFT	185	5 107,65
3220 13 3200	200	8"	KRAFT	210	5 114,10

3220

Kargaburun Düz Uçlu Ergonomik Seri
Long Nose Pliers (Flat)

TS 60 - TS ISO 5745
DIN ISO 5745



Özel alaşımli çelik, Kesici ağızlar indüksiyonda sertleştirilmiş
Special steel, Cutters induction hardened

KOD CODE	L mm	L inch	MODEL	g	TL/Ad.
3220 13 5140	140	5 1/2"	ERGONOMİK	110	5 91,20
3220 13 5160	160	6 1/4"	ERGONOMİK	140	5 103,10
3220 13 5180	180	7 1/8"	ERGONOMİK	160	5 113,35
3220 13 5200	200	8"	ERGONOMİK	170	5 120,10

3220

1000V İzoleli Elektrikçi Kargaburun
Insulated Electrician Type
Long Nose Pliers 1000V



TS 60
TS ISO 5745
DIN ISO 5745
⚡ 1000 V
IEC 60900



Özel alaşımli çelik, Kesici ağızlar indüksiyonda sertleştirilmiş, Krom kaplı
Special steel, Cutters induction hardened, Chrom plated

KOD CODE	L mm	L inch	MODEL	g	TL/Ad.
3220 13 6140	140	5 1/2"	1000V	110	5 100,45
3220 13 6160	160	6 1/4"	1000V	140	5 111,05
3220 13 6180	180	7 1/8"	1000V	160	5 124,65
3220 13 6200	200	8"	1000V	170	5 129,45

3225

Kargaburun Eğri Uçlu Opak Seri
Long Nose Pliers (Bent)

TS 60 - TS ISO 5745

3225

Kargaburun Eğri Uçlu Kraft Seri
Long Nose Pliers (Bent)

TS 60 - TS ISO 5745



4

Özel alaşımli çelik, Kesici ağızlar indüksiyonda sertleştirilmiş
Special steel, Cutters induction hardened

KOD CODE	L mm	L inch	MODEL	g	□	TL/Ad.
3225 13 2160	160	6 1/4"	OPAK	140	5	83,85
3225 13 2180	180	7 1/8"	OPAK	170	5	94,75
3225 13 2200	200	8"	OPAK	175	5	101,25

Özel alaşımli çelik, Kesici ağızlar indüksiyonda sertleştirilmiş
Special steel, Cutters induction hardened

KOD CODE	L mm	L inch	MODEL	g	□	TL/Ad.
3225 13 3160	160	6 1/4"	KRAFT	150	5	100,85
3225 13 3180	180	7 1/8"	KRAFT	190	5	110,75
3225 13 3200	200	8"	KRAFT	195	5	121,85



3700

Yan Keski Opak Seri
Side Cutting Pliers

TS 60 - TS ISO 5749
DIN ISO 5749



Özel alaşımlı çelik, Kesici ağızlar indüksiyonda sertleştirilmiş
Special steel, Cutters induction hardened

KOD CODE	L mm	L inch	MODEL	g	□	TL/Ad.
3700 16 2140	140	5 1/2"	OPAK	165	5	71,95
3700 16 2160	160	6 1/4"	OPAK	230	5	86,55
3700 16 2180	180	7 1/8"	OPAK	230	5	101,00

3700

Yan Keski Kraft Seri
Side Cutting Pliers

TS 60 • DIN ISO 5749
DIN ISO 5749



Özel alaşımlı çelik, Kesici ağızlar indüksiyonda sertleştirilmiş
Special steel, Cutters induction hardened

KOD CODE	L mm	L inch	MODEL	g	□	TL/Ad.
3700 16 3140	140	5 1/2"	KRAFT	190	5	86,75
3700 16 3160	160	6 1/4"	KRAFT	240	5	104,20
3700 16 3180	180	7 1/8"	KRAFT	255	5	121,45

3700

Yan Keski Ergonomik Seri
Side Cutting Pliers

TS 60 - TS ISO 5749
DIN ISO 5749



Özel alaşımlı çelik, Kesici ağızlar indüksiyonda sertleştirilmiş
Special steel, Cutters induction hardened

KOD CODE	L mm	L inch	MODEL	g	□	TL/Ad.
3700 16 5140	140	5 1/2"	ERGONOMİK	165	5	93,55
3700 16 5160	160	6 1/4"	ERGONOMİK	215	5	108,15
3700 16 5180	180	7 1/8"	ERGONOMİK	215	5	126,15

3700

1000V İzoleli Elektrikçi Yan Keski
Insulated Electrician Type Side Cutter 1000V

TS 60
TS ISO 5749
DIN ISO 5749
⚡ 1000 V

IEC 60900



Özel alaşımlı çelik, Kesici ağızlar indüksiyonda sertleştirilmiş, Krom kaplı
Special steel, Cutters induction hardened, Chrom plated

KOD CODE	L mm	L inch	MODEL	g	□	TL/Ad.
3700 16 6140	140	5 1/2"	1000V	165	5	104,20
3700 16 6160	160	6 1/4"	1000V	215	5	118,30
3700 16 6180	180	7 1/8"	1000V	225	5	132,35

YAN KESKİ OPAK SERİ / SIDE CUTTING PLIERS

Isıl işlem sonrası ilave indüksiyonla sertleştirme ile kullanım ömrü arttırılmış kesici ağızlar
Heat-treated and induction hardened cutting edges for long lifetime

Yüksek karbonlu sıcak dövme çeliği ile arttırılmış dayanım
High carbon forged steel for improved durability

TSE standartlarına uygun üretim
Production acc. to TSE standards



Ergonomik PVC izole
Ergonomic PVC handle

3705

İnce Uçlu Yan Keski (Plastikler İçin)
Side Cutter For Plastics

TS 60
TS ISO 5749

3730

Yan Keski Ağır Tip (çelik tel için)
Side Cutter Heavy Duty (for piano wire)

R&D
AR-GE



R&D
AR-GE

**4**

Özel alaşımli çelik, Kesici ağızlar indüksiyonda sertleştirilmiş, PVC izoleli
Special steel, Cutters induction hardened, PVC insulated

Özel alaşımli çelik, Kesici ağızlar indüksiyonda sertleştirilmiş
Special steel, Cutters induction hardened

KOD CODE	L mm	L inch	g	TL/Ad.
3705 16 5160	160	6 1/4	220	5 102,90

KOD CODE	L mm	L inch	g	TL/Ad.
3730 16 2160	160	6 1/4"	200	5 117,30
3730 16 2200	200	8"	320	5 152,45



3301

Dış Segman Pense (Düz)
Circlip Pliers, External (Flat)



TS 60
DIN 5254



Krom vanadyum, Krom kaplı, PVC izoleli
Chrom vanadium, Chrom plated, PVC insulated

KOD CODE	L mm	⌀	g	□	TL/Ad.
3301 12 0140	140	10 - 25	90	5	80,00
3301 12 0180	180	19 - 60	195	5	84,30
3301 12 0225	225	40 - 100	235	5	105,40
3301 12 0295	295	85 - 140	445	5	178,80

3321

İç Segman Pense (Düz)
Circlip Pliers Internal (Flat)



TS 60
DIN 5256



Krom vanadyum, Krom kaplı, PVC izoleli
Chrom vanadium, Chrom plated, PVC insulated

KOD CODE	L mm	⌀	g	□	TL/Ad.
3321 12 0140	140	12 - 25	100	5	73,60
3321 12 0180	180	19 - 60	185	5	77,70
3321 12 0225	225	40 - 100	250	5	96,75
3321 12 0310	310	85 - 140	445	5	166,00

4

3311

Dış Segman Pense (Eğri)
Circlip Pliers, External (Bent)



TS 60
DIN 5254



Krom vanadyum, Krom kaplı, PVC izoleli
Chrom vanadium, Chrom plated, PVC insulated

KOD CODE	L mm	⌀	g	□	TL/Ad.
3311 12 0125	125	10 - 25	105	5	89,40
3311 12 0170	170	19 - 60	190	5	94,15
3311 12 0210	210	40 - 100	250	5	108,20
3311 12 0275	275	85 - 140	445	5	187,70

3331

İç Segman Pense (Eğri)
Circlip Pliers Internal (Bent)



TS 60
DIN 5256



Krom vanadyum, Krom kaplı, PVC izoleli
Chrom vanadium, Chrom plated, PVC insulated

KOD CODE	L mm	⌀	g	□	TL/Ad.
3331 12 0130	130	12 - 25	105	5	79,15
3331 12 0170	170	19 - 60	185	5	83,35
3331 12 0210	210	40 - 100	250	5	104,00
3331 12 0290	290	85 - 140	440	5	178,60

3310

Çakma Uçlu Dış Segman Pense (Eğri)
Circlip Pliers, External Insert
Tips (Bent)



Krom vanadyum, Siyah oksit kaplı, PVC izoleli
Chrom vanadium, Black finish, PVC insulated

KOD CODE	L mm	⌀	g	□	TL/Ad.
★3310 12 0170	170	19 - 60	190	5	89,85

3320

Çakma Uçlu İç Segman Pense (Düz)
Circlip Pliers, Inside Driven
Tips (Flat)



Krom vanadyum, Siyah oksit kaplı, PVC izoleli
Chrom vanadium, Black finish, PVC insulated

KOD CODE	L mm	⌀	g	□	TL/Ad.
★3320 12 0140	140	8 - 25	100	5	70,25
★3320 12 0225	225	40 - 100	250	5	92,35

(★) İşaretli olan ürünler stoklarla sınırlıdır.
Limited with stocks.

3400

Sübap Segman Pense
Pliers for Valve Seals

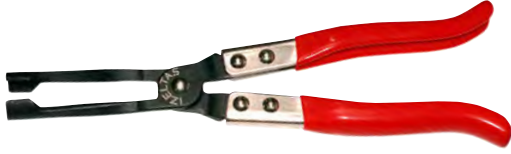

3420

Hortum Kelepçe Pensesi
Hose Clamp Pliers



4

KOD CODE	L mm	L inch	g		TL/Ad.
★3400 12 0275	275	11"	350	5	197,75

KOD CODE	L mm	L inch	g		TL/Ad.
3420 12 0220	220	8 3/4"	185	5	144,50

3405

Piston Segman Pense
Piston Ring Pliers



3425

Hortum Kelepçe Pensesi (Sıkıştırma Tipi)
Hose Clamp Pliers (Compression Type)



KOD CODE	L mm	ÖLÇÜ	g		TL/Ad.
★3405 12 0225	265	Ø60 - Ø160	200	5	138,25

KOD CODE	L mm	L inch	g		TL/Ad.
3425 12 0220	235	9 1/4"	355	5	148,05

3415

Fren Yay Pensesi
Brake Spring Pliers



3852

Delik Zımba
Revolving Punch Pliers



Krom vanadyum, Krom kaplı
Chrom vanadium, Chrom plated

KOD CODE	L mm	L inch	g		TL/Ad.
★3415 12 0320	320	13"	430	5	196,10
★3415 12 0525	525	20"	1190	5	453,90

Ölçü / Size ø2 - ø2.5 - ø3 - ø3.5 - ø4 - ø4.5

KOD CODE	L mm	L inch	g		TL/Ad.
3852 24 0225	225	9"	270	5	90,00

3715

Tek Ağızlı Kablo Kesici
Cable Cutter

R&D
AR-GE

4

Özel alaşımlı çelik, Kesici ağızlar induksiyonda sertleştirilmiş, PVC izoleli
Special steel, Cutters induction hardened, PVC insulated

KOD CODE	L mm	L inch	g	TL/Ad.
3715 16 0165	165	6 1/4	210	97,40

3715

1000V İzoleli Tek Ağızlı Kablo Kesici
Cable Cutter 1000V

⚡ 1000 V
IEC 60900

YENİ
NEW

R&D
AR-GE



Özel alaşımlı çelik, Kesici ağızlar induksiyonda sertleştirilmiş, PVC izoleli
Special steel, Cutters induction hardened, PVC insulated

KOD CODE	L mm	L inch	g	TL/Ad.
3715 16 6165	165	6 1/4	230	115,00

3720**Çift Ağızlı Kablo Kesici**
*Cable Cutter, Double Cutter***R&D
AR-GE****3860****Testere Çaprazı**
*Saw - Setting Pliers***TSEK****Özel alaşımli çelik, Kesici ağızlar indüksiyonda sertleştirilmiş, PVC izoleli**
*Special steel, Cutters induction hardened, PVC insulated***Özel alaşımli çelik, İndüksiyonda sertleştirilmiş, Natural Vernikli, PVC izoleli**
Special steel, induction hardened, PVC insulated

KOD CODE	L mm	L inch	g	TL/Ad.
3720 16 0220	220	8"	320	5 130,65

KOD CODE	L mm	L inch	g	TL/Ad.
3860 26 0180	180	7 1/8"	245	5 105,55



3550

Elektronikçi Yan Keski
Electronic Diagonal Side Cutting Pliers



Özel alaşımli çelik
Special steel

KOD CODE	L mm	g		TL/Ad.
3550 14 0125	125	76	5	84,05

3553

Elektronikçi Düz Uçlu Kargaburun
Electronic Flat Nose Pliers



Özel alaşımli çelik
Special steel

KOD CODE	L mm	g		TL/Ad.
3553 14 0150	150	88	5	83,85

4
3551

Elektronikçi Tepe Keski
Electronic End Cutting Pliers



Özel alaşımli çelik
Special steel

KOD CODE	L mm	g		TL/Ad.
3551 14 0125	125	77	5	84,05

3554

Elektronikçi Uzun Kargaburun
Electronic Long Nose Pliers



Özel alaşımli çelik
Special steel

KOD CODE	L mm	g		TL/Ad.
3554 14 0150	150	88	5	83,85

3552

Elektronikçi Yuvarlak Uçlu Kargaburun
Electronic Round Nose Pliers



Özel alaşımli çelik
Special steel

KOD CODE	L mm	g		TL/Ad.
3552 14 0125	125	78	5	84,05

3555

Elektronikçi Sivri Uçlu Düz Kargaburun
Electronic Needle Flat Nose Pliers



Özel alaşımli çelik
Special steel

KOD CODE	L mm	g		TL/Ad.
3555 14 0150	150	86	5	83,85

3556

Elektronikçi Sivri Uçlu Eğri Kargaburun
Electronic Needle Bent Nose Pliers



4

Özel alaşımlı çelik
Special steel

KOD CODE	L mm	g		TL/Ad.
3556 14 0150	150	85	5	83,85

3557

Elektronikçi Pense
Electronic Pliers



Özel alaşımlı çelik
Special steel

KOD CODE	L mm	g		TL/Ad.
3557 14 0125	125	80	5	84,05

3560 00 2104

Elektronikçi Keski ve Pense Seti (4 Parça)
Electronic Cutter & Pliers Set (4 Pcs)

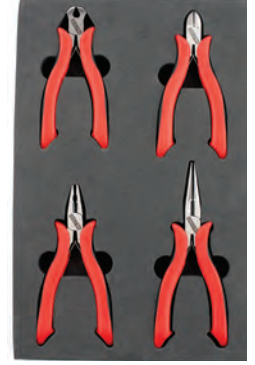

KOD CODE	L mm	İÇERİK CONTENTS		TL Ad.
3550 14 0125	125	Elektronikçi Yan Keski Electronic Diagonal Side Cutting Pliers	1	336,00
3551 14 0125	125	Elektronikçi Tepe Keski Electronic End Cutting Pliers	1	
3554 14 0150	150	Elektronikçi Uzun kargaburun Electronic Long Nose Pliers	1	
3557 14 0125	125	Elektronikçi Pense Electronic Pliers	1	

3565 00 2104

Elektronikçi Kargaburun Seti (4 Parça)
Electronic Long Nose Pliers Set (4 Pcs)

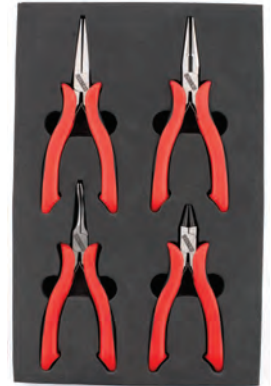

KOD CODE	L mm	İÇERİK CONTENTS		TL Ad.
3552 14 0125	125	Elektronikçi Yuvarlak Uçlu Kargaburun Electronic Round Nose Pliers	1	335,60
3553 14 0150	150	Elektronikçi Düz Uçlu Kargaburun Electronic Flat Nose Pliers	1	
3555 14 0150	150	Elektronikçi Sivri Uçlu Düz Kargaburun Electronic Needle Nose Pliers	1	
3556 14 0150	150	Elektronikçi Sivri Uçlu Eğri Kargaburun Electronic Bent Needle Nose Pliers	1	

(*) İşaretili olan ürünler stoklarla sınırlıdır.
Limited with stocks.

3800

Kerpeten
Carpenter Pincers

TS 60 - TS ISO 9243
DIN ISO 9243



Özel alaşımli çelik,
Kesici ağızlar indüksiyonda sertleştirilmiş,
Vernikli, PVC izoleli
*Special steel, Cutters induction hardened,
Lacquered, PVC insulated*

KOD CODE	L mm	L inch	g	TL/Ad.
3800 15 0160	160	6 1/4"	220	65,35
3800 15 0180	180	7 1/8"	295	67,60
3800 15 0200	200	8"	330	90,15
3800 15 0250	250	10"	530	98,25

3830

Betoncu Kerpeteni
Tower Pincers

TS 60 • TS ISO 9242
DIN ISO 9242



Özel alaşımli çelik, Kesici ağızlar indüksiyonda sertleştirilmiş,
Vernikli, PVC izoleli
*Special steel, Cutters induction hardened,
Lacquered, PVC insulated*

KOD CODE	L mm	L inch	g	TL/Ad.
3830 15 0225	225	9"	345	81,10
3830 15 0250	250	10"	395	89,60
3830 15 0280	280	11"	450	100,30

3831

Betoncu Kerpeteni Yaylı
Tower Pincers with spring

TS 60 - TS ISO 9242
DIN ISO 9242



Özel alaşımli çelik, Kesici ağızlar indüksiyonda sertleştirilmiş, Vernikli, PVC izoleli
*Special steel, Cutters induction hardened,
Lacquered, PVC insulated*

KOD CODE	L mm	L inch	g	TL/Ad.
3831 15 0280	280	11"	455	110,05

3835

Ağır Tip Betoncu Kerpeteni
Heavy Duty Tower Pincers

TS 60 - TS ISO 9242
DIN ISO 9242



Özel alaşımli çelik, Kesici ağızlar indüksiyonda sertleştirilmiş, Vernikli, PVC izoleli
*Special steel, Cutters induction hardened,
Lacquered, PVC insulated*

KOD CODE	L mm	L inch	g	TL/Ad.
3835 15 0280	280	11"	435	109,10

3850

Danalya
Shoemaker Pliers



Özel alaşımli çelik, indüksiyonda sertleştirilmiş, Siyah Oksit kaplı
Special steel, Induction hardened, Black finish

KOD CODE	L mm	L inch	g	TL/Ad.
3850 12 0200	200	8"	360	141,60



IZELTAS®

1000V İZOLELİ ALETLER

1000V INSULATED TOOLS



Güçlü kavrama sağlayan
tırnaklı tutma yüzeyleri
Toothed surface for strong grip

Isıl işlem sonrasında indüksiyonda
sertleştirme ile kullanım
ömrü artırılmış kesici ağzlar
Heat-treated and induction hardened
cutting edges for long lifetime

Nikel üzerine krom kaplama ile
korozyon direncinde
üst seviye koruma
High corrosion resistance
with chrome over nickel plating

Yüksek karbonlu
sıcak dövme çeliği
ile artırılmış
dayanım
High carbon forged
steel for improved
durability

VDE/GS belgeli, 1000V dayanımlı,
sert plastikten ve konforlu tutuş
sağlayan yumuşak elastomer
malzemeden imal edilmiş
dayanımı yüksek çift
komponentli ergonomik sap
VDE/GS certified, insulated for 1000V
usage. Two component ergonomic
handle with high strength and
soft grip plastic



0255

Süper İzole Çatal Bir Ağız Anahtar (mm)
Single Ended Open Jaw Wrench
Super Insulated (mm)

IEC 60900
⚡ 1000 V



Krom vanadyum, Krom kaplı, Kalın PVC izoleli
Chrom vanadium, Chrom plated, Triple PVC insulated

KOD CODE	mm	L mm	g	TL/Ad.
0255 01 0010	10	110	40	34,15
0255 01 0011	11	120	45	36,05
0255 01 0012	12	130	50	37,65
0255 01 0013	13	140	60	40,55
0255 01 0014	14	155	75	42,10
0255 01 0017	17	170	100	51,65
0255 01 0019	19	185	150	60,70
0255 01 0022	22	200	200	81,60
0255 01 0024	24	220	280	99,85

0435

Süper İzoleli Bir Ağız Yıldız Anahtar (mm)
Single Ended Ring Wrench Super
Insulated (mm)

IEC 60900
⚡ 1000 V



Krom vanadyum, Krom kaplı, Kalın PVC izoleli
Chrom vanadium, Chrom plated, Triple PVC insulated

KOD CODE	mm	L mm	g	TL/Ad.
0435 03 0010	10	170	100	45,55
0435 03 0011	11	180	110	45,55
0435 03 0012	12	190	130	51,65
0435 03 0013	13	200	150	51,65
0435 03 0014	14	215	180	54,25
0435 03 0017	17	230	220	61,45
0435 03 0019	19	245	270	73,35
0435 03 0022	22	260	310	80,40
0435 03 0024	24	280	420	107,45

2400

1000V İzoleli Ünsel Fort Pense
Insulated Type Waterpump
Pliers Universal 1000V

TS 60
TS ISO 8976
IEC 60900
⚡ 1000 V



Krom vanadyum, Krom kaplı, çift komponent saplı
Chrom vanadium, Chrom plated, Two component handle

KOD CODE	L mm	L inch	mm	g	TL/Ad.
2400 11 6240	240	9 1/2"	35	370	5 116,45

3020

1000V İzoleli Elektrikçi Kombine Pense
Insulated Electrician Type
Combination Pliers 1000V

TS 60
TS ISO 5746
DIN ISO 5746
⚡ 1000 V
IEC 60900



Özel alaşımli çelik, Kesici ağızlar indüksiyonda sertleştirilmiş, Krom kaplı
Special steel, Cutters induction hardened, Chrom plated



KOD CODE	L mm	L inch	MODEL	g	TL/Ad.
3020 12 6160	160	6 1/4"	1000V	205	5 93,70
3020 12 6180	180	7 1/8"	1000V	260	5 100,30
3020 12 6200	200	8"	1000V	345	5 113,25

(*) İşaretili olan ürünler stoklarla sınırlıdır.
Limited with stocks.

3220

1000V İzoleli Elektrikçi Kargaburun
Insulated Electrician Type
Nose Pliers 1000V

TSE
 TS 60
 TS ISO 5745
 DIN ISO 5745
 ⚡ 1000 V
 IEC 60900



3715

1000V İzoleli Tek Ağızlı Kablo Kesici
Cable Cutter 1000V

⚡ 1000 V
 IEC 60900

**YENİ
 NEW**

**R&D
 AR-GE**



5



Özel alaşımli çelik, Kesici ağızlar indüksiyonda sertleştirilmiş, Krom kaplı
Special steel, Cutters induction hardened, Chrom plated

Özel alaşımli çelik, Kesici ağızlar indüksiyonda sertleştirilmiş
Special steel, Cutters induction hardened

KOD CODE	L mm	L inch	MODEL	g	TL/Ad.
3220 13 6140	140	5 1/2"	1000V	110	5 100,45
3220 13 6160	160	6 1/4"	1000V	140	5 111,05
3220 13 6180	180	7 1/8"	1000V	160	5 124,65
3220 13 6200	200	8"	1000V	170	5 129,45

KOD CODE	L mm	L inch	MODEL	g	TL/Ad.
3715 16 6165	165	6 1/4"	1000V	150	5 115,00

3700

1000V İzoleli Elektrikçi Yan Keski
Insulated Electrician Type Side Cutter 1000V

TSE
 TS 60
 TS ISO 5749
 DIN ISO 5749
 ⚡ 1000 V
 IEC 60900



Özel alaşımli çelik, Kesici ağızlar indüksiyonda sertleştirilmiş, Krom kaplı
Special steel, Cutters induction hardened, Chrom plated

KOD CODE	L mm	L inch	MODEL	g	TL/Ad.
3700 16 6140	140	5 1/2"	1000V	165	5 104,20
3700 16 6160	160	6 1/4"	1000V	215	5 118,30
3700 16 6180	180	7 1/8"	1000V	225	5 132,35



(★) İşaretli olan ürünler stoklarla sınırlıdır.
Limited with stocks.

4140

1000V İzoleli Elektrikçi Düz Uçlu Tornavida
Insulated Electrician Type Flat
Screwdriver 1000V

TS 59
TS ISO 2380-1
DIN ISO 2380-1
⚡ 1000 V
IEC 60900

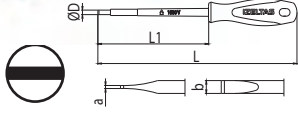
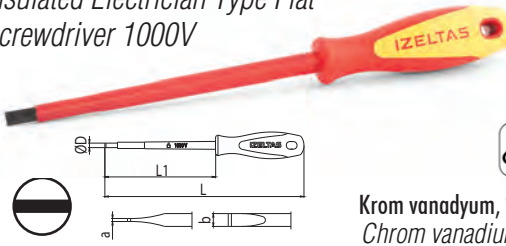

Krom vanadyum, Siyah oksit kaplı
Chrom vanadium, Black finish

KOD CODE	øDxL1 mm	-		L mm	g	□	TL/Ad.
		a mm	b mm				
4140 17 2575	2.5x75	0.4	2.5	150	25	10	14,35
4140 17 4100	4x100	0.8	4	185	40	10	16,90
4140 17 5512	5.5x125	1	5.5	220	70	10	22,30
4140 17 6515	6.5x150	1.2	6.5	245	90	10	24,95

4145

1000V İzoleli Elektrikçi Yıldız Uçlu Tornavida
Insulated Electrician Type Phillips
Screwdriver 1000V

TS 59 TS 59-5
ISO 8764 DIN ISO 8764
⚡ 1000 V
IEC 60900

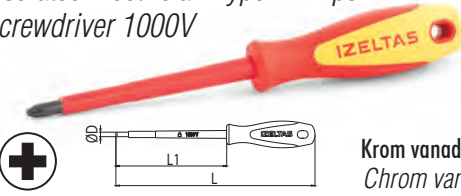

Krom vanadyum, Siyah oksit kaplı
Chrom vanadium, Black finish

KOD CODE	øDxL1 mm	+	L mm	g	□	TL/Ad.
4145 18 4580	4.5x80	Ph1	165	45	10	21,20
4145 18 6100	6x100	Ph2	195	70	10	24,95

4140

1000V İzoleli Elektrikçi Tornavida Seti (6 Parça)
Insulated Electrician Set (6 Pcs) Screwdriver 1000V



KOD CODE	İÇERİK CONTENTS	g	□	TL/Ad.
4140 00 9106	2.5x75 - 4x100	340	6	124,65
	5.5x125 - 6.5x150			
	Düz uçlu / Flat			
	4.5x80 - 6x100			
	Yıldız uçlu / Phillips			

4773

1000V Süngüsü İzoleli Lokma Uçlu Tornavida
Nut Spinner, Electrician Blade Insulated
1000V

DIN 3125

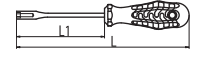

Krom vanadyum, iki komponent saplı
Chrome vanadium, Two component handle

KOD CODE	mm	L mm	L1 mm	g	□	TL/Ad.
4773 19 0040	4	220	125	90	10	48,40
4773 19 0050	5	220	125	90	10	48,40
4773 19 0055	5.5	220	125	90	10	48,40
4773 19 0060	6	220	125	90	10	48,40
4773 19 0070	7	230	125	110	10	51,90
4773 19 0080	8	230	125	120	10	51,90
4773 19 0090	9	230	125	125	10	56,05
4773 19 0100	10	230	125	125	10	56,05
4773 19 0110	11	230	125	140	10	61,20
4773 19 0120	12	230	125	145	10	65,65
4773 19 0130	13	230	125	150	10	70,75
4773 19 0140	14	230	125	150	10	78,25

4773

1000V Süngüsü İzoleli Lokma Uçlu Tornavida Seti (8 Parça)
Nut Spinner, Electrician Blade Insulated Set (8 Pcs)
1000V



KOD CODE	İÇERİK CONTENTS	g	□	TL/Ad.
4773 00 8108	6 - 7 - 8 - 9 - 10 - 11 - 12 - 13	2225	8	461,90

(*) İşaretili olan ürünler stoklarla sınırlıdır.
Limited with stocks.

4783

1000V Süngüsü İzoleli Manyetik Bits Tutucu Tornavida
Screwdriver, Magnetic Bit Holder Insulated
1000V

△ 1000 V
IEC 60900

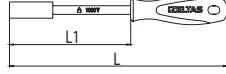

KOD CODE	Ø mm	L mm	L1 mm	g	TL/Ad.
4783 19 6120	6.3	230	120	115	10

8440 00 1023

19" Plastik Takım Çantası Elektrikçi Set (23 Parça)
Plastic Tool Box for Electrician 19" (23 Pcs)

YENİ
NEW



KOD CODE	İÇERİK CONTENTS	TL/Ad.
8440 33 1019	19" Plastik Takım Çantası Plastic Tool Box	1
3700 16 6160	160 mm 1000V İzoleli Elektrikçi Yan Keski Insulated Electrician Type Side Cutter 1000V	1
3020 12 6180	180 mm 1000V İzoleli Elektrikçi Kombine Pense Insulated Electrician Type Combination Pliers 1000V	1
3220 13 6160	160 mm 1000V İzoleli Elektrikçi Düz Kargaburun Insulated Electrician Type Nose Pliers 1000V	1
4773 19 0100	1000V Süngüsü İzoleli Lokma Uçlu Tornavida 10mm Nut Spinner, Electrician Blade Insulated 1000V	1
4773 19 0130	1000V Süngüsü İzoleli Lokma Uçlu Tornavida 13mm Nut Spinner, Electrician Blade Insulated 1000V	1
3715 16 6165	165mm 1000V İzoleli Elektrikçi Tek Ağız Kablo Kesici Cable Cutter 1000V	1
4520 18 0360	3x60 Klemens Yıldız Tornavida Electronic Screwdriver, Phillips	1
4520 18 0480	4x80 Klemens Yıldız Tornavida Electronic Screwdriver, Phillips	1
4500 17 0380	3x80 Klemens Düz Tornavida Electronic Screwdriver, Flat	1
4500 17 0480	4x80 Klemens Düz Tornavida Electronic Screwdriver, Flat	1
4140 17 4100	4x100 1000V İzoleli Elektrikçi Düz Tornavida Insulated Electrician Type Flat Screwdriver 1000V	1
4145 18 4580	4,5x80 1000V İzoleli Elektrikçi Yıldız Tornavida Insulated Electrician Type Phillips Screwdriver 1000V	1
4145 18 6100	6x100 1000V İzoleli Elektrikçi Yıldız Tornavida Insulated Electrician Type Phillips Screwdriver 1000V	1
4550 17 0190	190 mm Kontrol Kalemi Voltage Tester Flat	1
4560 18 0190	190 mm Yıldız Kontrol Kalemi Voltage Tester Phillips	1
4783 19 6120	6.3x120 1000V İzoleli Elektrikçi Manyetik Bits Tutucu Tornavida Screwdriver, Magnetic Bit Holder Insulated 1000V	1
4800 00 8106	6 lı Bits Set (25 mm) Bit Set 6 Pcs	6

5 8795 00 6005

1000V İzoleli Elektrikçi Seti (5 Parça)
1000V Insulated Tool Set (5 Pcs)



KOD CODE	İÇERİK CONTENTS	TL/Ad.
3020 12 6180	180 mm 1000V İzoleli Elektrikçi Kombine Pense Insulated Electrician Type Combination Pliers 1000V	1
3220 13 6200	200 mm 1000V İzoleli Elektrikçi Kargaburun Insulated Electrician Type Nose Pliers	1
3700 16 6160	160 mm 1000V İzoleli Elektrikçi Yan Keski Insulated Electrician Type Nose	1
4140 17 5512	5.5x125 1000V Elektrikçi Düz Uçlu Tornavida Insulated Electrician Type Flat Screwdriver 1000V	1
4145 18 6100	6x100 1000V İzoleli Elektrikçi Yıldız Uçlu Tornavida Insulated Electrician Type Phillips Screwdriver 1000V	1

1000V ELEKTRİKÇİ DÜZ TORNAVİDA / INSULATED ELECTRICIAN TYPE PLAT SCREWDRIVER 1000V

Vida yuvalarına tam oturmayı sağlayan hassas işlenmiş uçlar.
Precise machined slot to mate screw heads.

Yüksek mukavemetli alaşımlı çelik
High strength alloyed steel

Siyah oksit kaplama
Black finish.

1000V dayanımlı izoleli alan
1000V insulated blade

VDE/GS belgeli, 1000V dayanımlı, sert plastikten ve konforlu tutuş sağlayan yumuşak elastomer malzemeden imal edilmiş dayanımı yüksek çift komponentli ergonomik sap
VDE/GS certified, insulated for 1000V usage. Two component ergonomic handle with high strength and soft grip plastic

Askı deliği
Rock hole





IZELTAS®

TORNAVİDA VE ALLEN ANAHTARLAR

SCREWDRIVERS AND HEX KEY WRENCHES

Tornavidalar
Screwdrivers

Kontrol Kalemleri
Testers

Bits Uçlar ve Aparatları
Bits

Allen Anahtarlar
Hex Key Wrenches



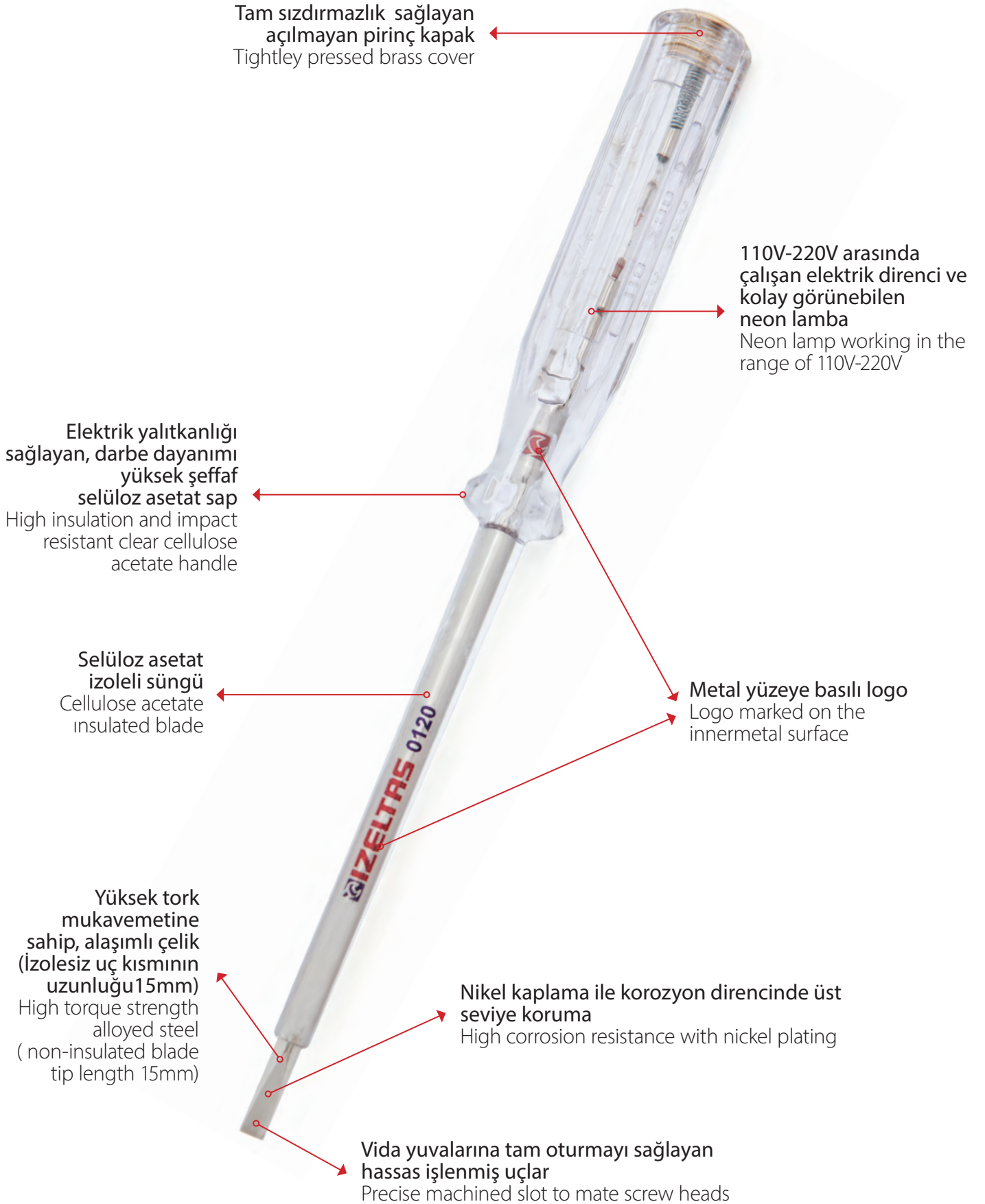

4550

Elektrik Kontrol Kalemi (Düz Uçlu) Voltage Tester (Flat)

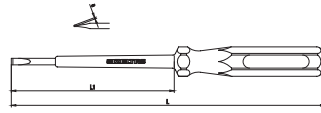
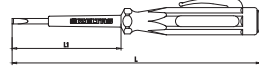

Krom vanadyum, Nikel kaplı, Şeffaf selüloz asetat saplı
Chrom vanadium, Nickel plated, Transparent cellulose acetate handle

KOD CODE	L mm	⊖		L1 mm	g	□	TL/ Ad.
		a mm	b mm				
4550 17 0135	135	0.5	3	60	20	10	15,20
4550 17 0190	190	0.8	4	100	40	10	19,10

4555

Master Kontrol Kalemi (Düz Uçlu) Voltage Tester Master (Flat)

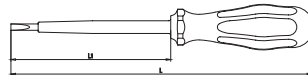

Krom vanadyum, Nikel kaplı, Şeffaf selüloz asetat saplı
Chrom vanadium, Nickel plated, Transparent cellulose acetate handle

KOD CODE	L mm	⊖		L1 mm	g	□	TL/ Ad.
		a mm	b mm				
4555 17 0165	165	0.5	3.5	88	40	10	20,95

4560

Elektrik Kontrol Kalemi (Yıldız Uçlu) Voltage Tester Phillips

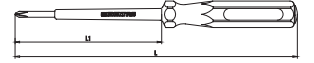
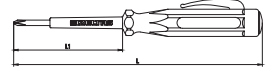

Krom vanadyum, Nikel kaplı, Şeffaf selüloz asetat saplı
Chrom vanadium, Nickel plated, Transparent cellulose acetate handle

KOD CODE	L mm	L1 mm	+	g	□	TL/ Ad.
4560 18 0135	135	60	Ph0	20	10	16,60
4560 18 0190	190	100	Ph0	35	10	20,95

6

4565

Oto Kontrol Kalemi Car Voltage Tester

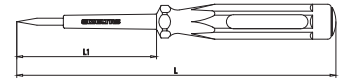

Krom vanadyum, Krom kaplı, Şeffaf selüloz asetat saplı
Chrom vanadium, Chrom plated, Transparent cellulose acetate handle

Tüm otomobil ve ağır vasıta araçlarda 6-24V arası elektrik tesisatının kontrol edilmesinde kullanılır. Sivri uçlu olması sebebiyle kablo ve soketleri yerinden sökmeden kontrol kolaylığı sağlar.

Tool is used to control 6-24V electrical wiring in all cars and heavy duty vehicles. With its point tip, wires and sockets are not required to be disassembled.

KOD CODE	L mm	L1 mm	⊙	Kablo L (m)	g	□	TL/ Ad.
4565 17 0135	135	60		1	30	10	41,00

(★) İşaretili olan ürünler stoklarla sınırlıdır.
Limited with stocks.

Kraft Seri Düz Uçlu Tornavida
Screwdriver, Kraft, Flat

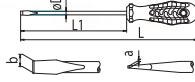
 TS ISO 2380 - 1
 DIN ISO 2380-1

Krom vanadyum, Krom kaplı, Ucu siyah oksit, Selüloz asetat saplı
Chrom vanadium, Chrom plated and black tip, Cellulose acetate handle

KOD CODE	øDxL1 mm	⊖		L mm	g	□	TL/Ad.
		a mm	b mm				
4100 17 0340	3x40	0.5	3	110	20	10	11,20
4100 17 0380	3x80	0.5	3	155	35	10	11,90
4100 17 0480	4x80	0.8	4	165	50	10	12,85
4100 17 4100	4x100	0.8	4	185	50	10	14,90
4100 17 0580	5x80	1.0	5.5	175	70	10	15,75
4100 17 5100	5x100	1.0	5.5	195	75	10	17,35
4100 17 5125	5x125	1.0	5.5	220	80	10	19,85
4100 17 5150	5x150	1.0	5.5	245	80	10	21,65
4100 17 6100	6x100	1.2	6.5	195	85	10	17,80
4100 17 6125	6x125	1.2	6.5	220	90	10	20,40
4100 17 6150	6x150	1.2	6.5	245	95	10	22,35
4100 17 6175	6x175	1.2	6.5	270	100	10	28,75
4100 17 7125	7x125	1.2	8	230	120	10	22,70
4100 17 7150	7x150	1.2	8	255	130	10	26,25
4100 17 7175	7x175	1.2	8	280	135	10	30,10
4100 17 8150	8x150	1.6	10	255	145	10	29,85
4100 17 8175	8x175	1.6	10	280	150	10	31,80
4100 17 8200	8x200	1.6	10	305	160	10	38,95
4100 17 9200	9x200	2.0	12	305	190	10	41,55
4100 17 1125	11x250	2.5	14	365	305	10	52,80

Kraft Seri Düz Uçlu Tornavida Seti (8 Parça)
Screwdriver, Flat, Kraft Set (8 Pcs)

KOD CODE	İÇERİK CONTENTS	g	□	TL/Ad.
4100 00 8108	3x80 - 4x80 - 4x100 5x100 - 5x125 - 6x100 6x125 - 6x150 ⊖ Düz uçlu / Flat	550	8	137,40

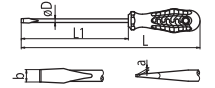
Kraft Seri Süngüsü Uzun Düz Uçlu Tornavida
Screwdriver, Kraft, Flat, Long

Krom vanadyum, Krom kaplı, Ucu siyah oksit, Selüloz asetat saplı
Chrom vanadium, Chrom plated and black tip, Cellulose acetate handle

KOD CODE	øDxL1 mm	⊖		L mm	g	□	TL/Ad.
		a mm	b mm				
★ 4100 17 4250	4x250	0.8	4	335	65	10	35,80
4100 17 4300	4x300	0.8	4	385	70	10	36,75
4100 17 5250	5x250	1.0	5.5	345	95	10	41,05
★ 4100 17 5300	5x300	1.0	5.5	395	105	10	42,75
4100 17 5350	5x350	1.0	5.5	445	115	10	46,40
4100 17 6350	6x350	1.2	6.5	445	125	10	49,10



(★) İşaretli olan ürünler stoklarla sınırlıdır.
Limited with stocks.

4120

Kraft Seri Yıldız Uçlu Tornavida
Screwdriver, Kraft, Phillips

TS 59 - 5 ISO 8764-1
DIN ISO 8764-1

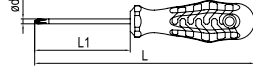

Krom vanadyum, Krom kaplı, Ucu siyah oksit, Selüloz asetat saplı
Chrom vanadium, Chrom plated and black tip,
Cellulose acetate handle.

KOD CODE	ødxL1 mm	+	L mm	g	TL/Ad.
4120 18 0360	3x60	Ph0	135	30	10 12,60
4120 18 4580	4.5x80	Ph1	165	55	10 18,15
4120 18 5100	4.5x100	Ph1	185	55	10 20,25
4120 18 5150	4.5x150	Ph1	235	60	10 24,25
4120 18 6100	6x100	Ph2	195	85	10 21,90
4120 18 6150	6x150	Ph2	245	95	10 26,25
4120 18 6200	6x200	Ph2	295	105	10 34,05
4120 18 8150	8x150	Ph3	255	150	10 41,60
4120 18 1200	10x200	Ph4	315	240	10 64,35

4120

Kraft Seri Süngüsü Uzun Yıldız Uçlu Tornavida
Screwdriver, Kraft, Phillips, Long

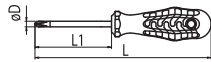

Krom vanadyum, Krom kaplı, Ucu siyah oksit, Selüloz asetat saplı
Chrom vanadium, Chrom plated and black tip,
Cellulose acetate handle

KOD CODE	øDxL1 mm	+	L mm	g	TL/Ad.
4120 18 5300	4.5x300	Ph1	385	80	10 57,45
4120 18 6300	6x300	Ph2	395	125	10 59,40

4120

Kraft Seri Yıldız Uçlu Tornavida Seti (6 parça)
Screwdriver, Kraft, Phillips, Set (6 Pcs)



KOD CODE	İÇERİK CONTENTS	g	TL/Ad.
4120 00 8106	3x60 - 4.5x80 4.5x100 - 4.5x150 6x100 - 6x150 Yıldız uçlu / Phillips	380	6 123,40

6
4100

Kraft Seri Tornavida Seti (7 parça)
Screwdriver Set, Kraft (7 Pcs)



KOD CODE	İÇERİK CONTENTS	g	TL/Ad.
4100 00 8107	3x80 - 4x80 - 4x100 5x125 - 6x150 Düz uçlu / Flat 4.5x80 - 6x100 Yıldız uçlu / Phillips	445	7 121,90

(★) İşaretili olan ürünler stoklarla sınırlıdır.
Limited with stocks.

4110
Kraft Seri Düz Uçlu Topaç Tornavida
Screwdriver, Kraft, Stubby, Flat

TS 59

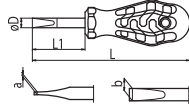
Krom vanadyum, Krom kaplı, Ucu siyah oksit, Selüloz asetat saplı
Chrom vanadium, Chrom plated and black tip, Cellulose acetate handle
4130
Kraft Seri Yıldız Uçlu Topaç Tornavida
Screwdriver, Kraft, Stubby, Phillips

TS 59 -5

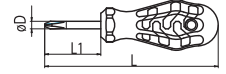
Krom vanadyum, Krom kaplı, Ucu siyah oksit, Selüloz asetat saplı
Chrom vanadium, Chrom plated and black tip, Cellulose acetate handle
6

KOD CODE	ØDxL1 mm	⊖		L mm	g	□	TL/Ad.
		a mm	b mm				
★4110 17 0425	4x25	0.8	4	70	40	5	11,20
4110 17 5525	5.5x25	1	5.5	70	30	5	12,95
4110 17 5540	5.5x40	1	5.5	105	45	5	17,50
4110 17 6525	6.5x25	1.2	6.5	70	35	5	14,35
4110 17 6540	6.5x40	1.2	6.5	105	50	5	19,85
★4110 17 0825	8x25	1.2	8	70	40	5	15,70

KOD CODE	ØDxL1 mm	⊕	L mm	g	□	TL/Ad.
4130 18 4540	4.5x40	Ph1	105	40	5	17,40
4130 18 0625	6x25	Ph2	70	30	5	14,45
4130 18 0640	6x40	Ph2	105	50	5	19,60



4140

1000V İzoleli Elektrikçi Düz Uçlu Tornavida
Insulated Electrician Type Flat
Screwdriver 1000V

TS 59 TS ISO 2380-1
DIN ISO 2380-1
⚡ 1000 V
IEC 60900

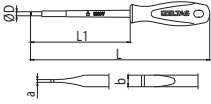

Krom vanadyum, Siyah oksit kaplı
Chrom vanadium, Black finish

KOD CODE	øDxL1 mm	-		L mm	g	□	TL/Ad.
		a mm	b mm				
4140 17 2575	2.5x75	0.4	2.5	150	25	10	14,35
4140 17 4100	4x100	0.8	4	185	40	10	16,90
4140 17 5512	5.5x125	1	5.5	220	70	10	22,30
4140 17 6515	6.5x150	1.2	6.5	245	90	10	24,95

4140

1000V İzoleli Elektrikçi Tornavida Seti (6 Parça)
Insulated Electrician Set (6 Pcs) Screwdriver 1000V



KOD CODE	İÇERİK CONTENTS	g	□	TL/Ad.
4140 00 9106	2.5x75 - 4x100	340	6	124,65
	5.5x125 - 6.5x150			
	Düz uçlu / Flat			
	4.5x80 - 6x100			
	Yıldız uçlu / Phillips			

4145

1000V İzoleli Elektrikçi Yıldız Uçlu Tornavida
Insulated Electrician Type Phillips
Screwdriver 1000V

TS 59 TS 59-5
ISO 8764 DIN ISO 8764
⚡ 1000 V
IEC 60900

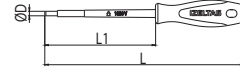

Krom vanadyum, Siyah oksit kaplı
Chrom vanadium, Black finish

KOD CODE	øDxL1 mm	+	L mm	g	□	TL/Ad.
4145 18 0360	3x60	Ph0	135	25	10	15,00
4145 18 4580	4.5x80	Ph1	165	45	10	21,20
4145 18 6100	6x100	Ph2	195	70	10	24,95

4101

Süngüsü İzoleli Düz Uçlu Tornavida
Screwdriver, Electrician Blade,
Insulated, Flat

TS 59
⚡ 1000 V
IEC 60900

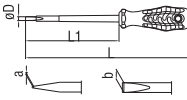

Krom vanadyum, Siyah oksit kaplı
Chrom vanadium, Black finish

KOD CODE	øDxL1 mm	-		L mm	g	□	TL/Ad.
		a mm	b mm				
★4101 17 2575	2.5x75	0.4	2.5	150	25	10	14,00
★4101 17 4100	4x100	0.8	4	185	40	10	17,70
★4101 17 5512	5.5x125	1	5.5	220	70	10	24,50
★4101 17 6515	6.5x150	1.2	6.5	245	90	10	26,65

4121

Süngüsü İzoleli Yıldız Uçlu Tornavida
Screwdriver, Electrician Blade,
Insulated, Phillips

TS 59
⚡ 1000 V
IEC 60900

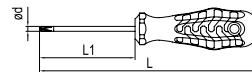

Krom vanadyum, Siyah oksit kaplı
Chrom vanadium, Black finish

KOD CODE	øDxL1 mm	+	L mm	g	□	TL/Ad.
★4121 18 0360	3x60	Ph0	135	25	10	16,60
★4121 18 4580	4.5x80	Ph1	165	45	10	22,20
★4121 18 6100	6x100	Ph2	195	70	10	27,00

(★) İşaretili olan ürünler stoklarla sınırlıdır.
Limited with stocks.

4300

Opak Seri Düz Uçlu Tornavida
Screwdriver, Opak, Flat

TS ISO 2380-1
DIN ISO 2380-1



Krom vanadyum, Krom kaplı, Ucu siyah oksit, PP saplı
Chrome vanadium, Chrom plated and black tip, PP handle

KOD CODE	øDxL1 mm	⊖		L mm	g	□	TL/Ad.
		a mm	b mm				
4300 17 0380	3x80	0.5	3	155	25	10	10,45
4300 17 0480	4x80	0.8	4	165	35	10	10,80
4300 17 4100	4x100	0.8	4	185	40	10	12,95
4300 17 5100	5x100	1.0	5.5	195	60	10	15,60
4300 17 5125	5x125	1.0	5.5	220	60	10	18,15
4300 17 6100	6x100	1.2	6.5	195	65	10	16,25
4300 17 6125	6x125	1.2	6.5	220	70	10	18,55
4300 17 6150	6x150	1.2	6.5	245	80	10	20,30
4300 17 7125	7x125	1.2	8	230	95	10	20,75
4300 17 7150	7x150	1.2	8	255	105	10	23,85
4300 17 8175	8x175	1.6	10	280	130	10	29,00
4300 17 9200	9x200	2.0	12	305	165	10	38,30

4300

Opak Seri Tornavida Seti (7 Parça)
Screwdriver Set, Opak (7 Pcs)



KOD CODE	İÇERİK CONTENTS	g	□	TL/Ad.
4300 00 8107	3x80 - 4x80 - 4x100	520	7	109,10
	5x125 - 6x150			
	Düz uçlu / Flat			
	4.5x80 - 6x100			
	Yıldız uçlu / Phillips			

4320

Opak Seri Yıldız Uçlu Tornavida
Screwdriver, Opak, Phillips

TS 59 - 5 ISO 8764
DIN ISO 8764



Krom vanadyum, Krom kaplı, Ucu siyah oksit, PP saplı
Chrome vanadium, Chrom plated and black tip, PP handle

KOD CODE	øDxL1 mm	+	L mm	g	□	TL/Ad.
4320 18 0360	3x60	Ph0	135	25	10	11,50
4320 18 4580	4.5x80	Ph1	165	40	10	16,50
4320 18 6100	6x100	Ph2	195	70	10	19,95
4320 18 8150	8x150	Ph3	255	140	10	37,90

4325

Opak Seri Pozidriv Yıldız Uçlu Tornavida
Screwdriver, Opak, Pozidriv

DIN ISO 8764



Krom vanadyum, Krom kaplı, Ucu siyah oksit, PP saplı
Chrome vanadium, Chrom plated and black tip, PP handle

KOD CODE	øDxL1 mm	+	L mm	g	□	TL/Ad.
4325 18 0360	3x60	Pz0	135	25	10	12,60
4325 18 4580	4.5x80	Pz1	165	40	10	18,15
4325 18 6100	6x100	Pz2	195	70	10	21,90
4325 18 8150	8x150	Pz3	255	140	10	41,60

4350

Ergonomik Seri Düz Uçlu Tornavida Screwdriver, Ergonomic, Flat

TS ISO 2380-1
DIN ISO 2380-1

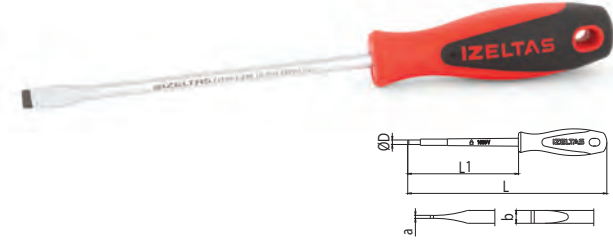

Krom vanadyum, Krom kaplı, Ucu siyah oksit, İki komponent saplı
Chrome vanadium, Chrom plated and black tip,
Two component handle.

KOD CODE	øDxL1 mm	—		L mm	g	□	TL/Ad.
		a mm	b mm				
4350 17 0380	3x80	0.5	3	155	25	10	12,95
4350 17 0480	4x80	0.8	4	165	40	10	13,55
4350 17 4100	4x100	0.8	4	185	40	10	15,45
4350 17 5100	5x100	1.0	5.5	195	60	10	17,80
4350 17 5125	5x125	1.0	5.5	220	65	10	20,55
4350 17 6100	6x100	1.2	6.5	195	70	10	18,40
4350 17 6125	6x125	1.2	6.5	220	75	10	21,10
4350 17 6150	6x150	1.2	6.5	245	80	10	23,15
4350 17 7125	7x125	1.2	8	230	100	10	23,60
4350 17 7150	7x150	1.2	8	255	110	10	27,10
4350 17 8175	8x175	1.6	10	280	140	10	32,95
4350 17 9200	9x200	2	12	305	180	10	42,00

4370

Ergonomik Seri Yıldız Uçlu Tornavida Screwdriver, Ergonomic, Phillips

TS 59 - 5
ISO 8764-1
DIN ISO 8764-1



Krom vanadyum, Krom kaplı, Ucu siyah oksit, İki komponent saplı
Chrome vanadium, Chrom plated and black tip,
Two component handle

KOD CODE	øDxL1 mm	+	L mm	g	□	TL/Ad.
4370 18 4580	4.5x80	Ph1	165	45	10	18,80
★4370 18 5100	4.5x100	Ph1	185	50	10	20,70
★4370 18 5150	4.5x150	Ph1	235	70	10	23,50
4370 18 6100	6x100	Ph2	195	70	10	22,80
★4370 18 6150	6x150	Ph2	245	150	10	27,50
4370 18 8150	8x150	Ph3	255	130	10	43,00

4350

Ergonomik Seri Tornavida Seti (7 Parça) Screwdriver Set, Ergonomic (7 Pcs.)



KOD CODE	İÇERİK CONTENTS	g	□	TL/Ad.
4350 00 8107	3x80 - 4x80 - 4x100	370	7	127,25
	—			
	Düz uçlu / Flat			
	4.5x80 - 6x100			
	Yıldız uçlu / Phillips			

6



(★) İşaretili olan ürünler stoklarla sınırlıdır.
Limited with stocks.

4240

Değişken Uçlu Tornavida
Screwdriver - Reversible

TSEK

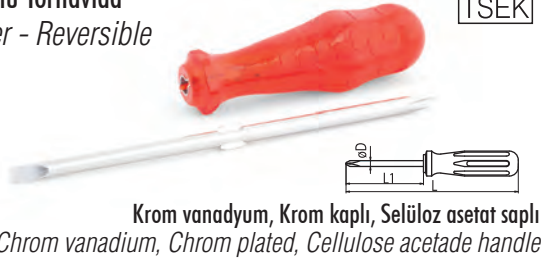

Krom vanadyum, Krom kaplı, Selüloz asetat saplı
Chrom vanadium, Chrom plated, Cellulose acetate handle

KOD CODE	ØDxL1 mm	± axb mm	+	L mm	g	TL/Ad.	
4240 17 0680	6x80	1.2x6	Ph2	175	80	10	22,90

4240

Değişken Uçlu Tornavida Takımı
Screwdriver Set - Reversible

TSEK



KOD CODE	ØDxL1 mm	± axb mm	+	L mm	g	TL/Ad.	
4240 00 7102	6x80	1.2x6	Ph2	175	105	1	43,70
	4x80	0.8x4.5	Ph1				

4500

Elektronikçi Tip (Klemens) Düz Uçlu Tornavida
Electronic Screwdriver, Flat

6



Krom vanadyum, Krom kaplı, Ucu siyah oksit, PP saplı
Chrome vanadium, Chrom plated and black tip, PP handle

KOD CODE	ØDxL1 mm	±		L mm	g	TL/Ad.	
		a mm	b mm				
4500 17 2560	2.5x60	0.4	2.5	140	15	10	10,15
4500 17 2580	2.5x80	0.4	2.5	160	15	10	10,65
4500 17 0380	3x80	0.5	3	160	15	10	11,25
4500 17 3100	3x100	0.5	3	180	20	10	13,75
4500 17 3125	3x125	0.5	3	205	20	10	18,15
4500 17 3510	3.5x100	0.6	3.5	180	20	10	14,20
4500 17 0480	4x80	0.8	4	160	20	10	11,55
4500 17 4100	4x100	0.8	4	180	20	10	14,20
4500 17 4125	4x125	0.8	4	205	25	10	19,10
4500 17 4150	4x150	0.8	4	230	25	10	20,80

4520

Elektronikçi Tip (Klemens) Yıldız Uçlu Tornavida
Electronic Screwdriver, Phillips



Krom vanadyum, Krom kaplı, Ucu siyah oksit, PP saplı
Chrome vanadium, Chrom plated and black tip, PP handle

KOD CODE	ØDxL1 mm	+	L mm	g	TL/Ad.	
4520 18 0360	3x60	Ph0	140	15	10	11,90
4520 18 0480	4x80	Ph0	160	20	10	17,10
4520 18 4150	4x150	Ph0	230	25	10	22,85

4500

Elektronikçi Tip (Klemens) Tornavida Seti (6 Parça)
Electronic Screwdriver Set (6 Pcs)



KOD CODE	İÇERİK CONTENTS	g	TL/Ad.	
4500 00 8106	3x80 - 3x100 3x125 - 4x150 Düz uçlu / Flat	115	6	92,95
	3x60 - 4x80 Yıldız uçlu / Phillips			

4540

Klips Sökme Tornavidası
Hupcap and Clip Remover

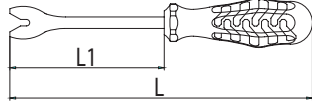

Krom vanadyum, Krom kaplı, PP Saplı
Chrom vanadium, Chrom plated, PP insulated

KOD CODE	L mm	L1	g	TL/Ad.
4540 19 0190	290	180	160	10 44,40

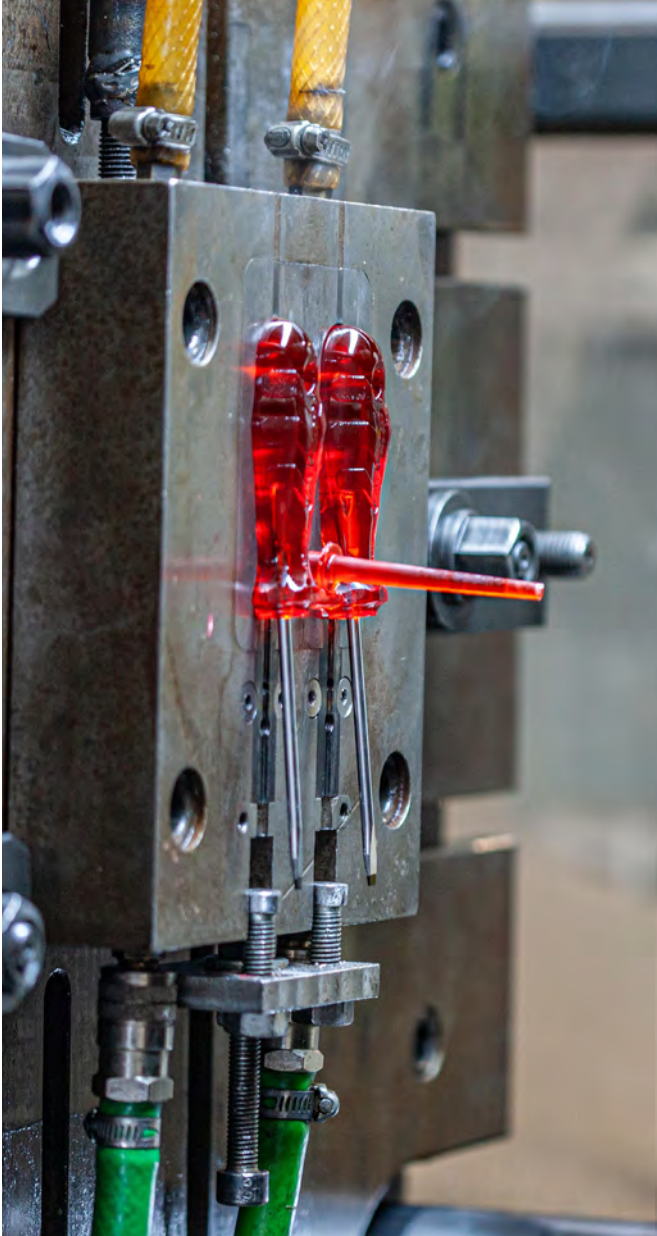
4530

Elektronikçi Tip (Klemens) Torx® Uçlu Tornavida
Electronic Screwdriver, Torx®

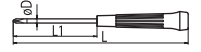

Krom vanadyum, Krom kaplı, Ucu siyah oksit, PP saplı
Chrome vanadium, Chrom plated and black tip, PP handle

KOD CODE	øDxL1 mm	★	L mm	g	TL/Ad.
4530 17 0560	2.5x60	T5	145	15	10 14,40
4530 17 0660	2.5x60	T6	145	15	10 14,40
4530 17 0760	3x60	T7	145	15	10 14,90
4530 17 0860	3x60	T8	145	20	10 14,90
4530 17 0960	3x60	T9	145	20	10 14,90
4530 17 1060	3.5x60	T10	145	20	10 14,90

6
4530

Elektronikçi Tip (Klemens) Torx® Uçlu Tornavida Seti (6 Parça)
Electronic Screwdriver Set Torx (6 Pcs)



KOD CODE	İÇERİK CONTENTS	g	TL/Ad.
4530 00 1006	T5 - T6 - T7 - T8 - T9 - T10	115	6 88,40

(★) İşaretili olan ürünler stoklarla sınırlıdır.
Limited with stocks.

4765

T Kol Lokma Uçlu Tornavida (mm)
Nut Spinner With T-Handle (mm)

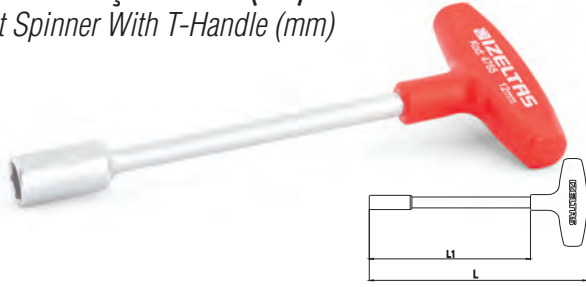

Krom vanadyum, Krom kaplı, PP Saplı
Chrom vanadium, Chrom plated, PP insulated

KOD CODE	mm	L mm	L1 mm	g	TL/Ad.	
4765 19 0040	4	185	135	75	10	28,40
4765 19 0050	5	185	135	75	10	28,40
4765 19 0055	5.5	185	135	75	10	28,40
4765 19 0060	6	185	135	75	10	28,40
4765 19 0070	7	185	135	90	10	30,30
4765 19 0080	8	185	135	95	10	30,30
4765 19 0090	9	185	135	100	10	33,60
4765 19 0100	10	185	135	100	10	33,60
4765 19 0110	11	185	135	110	10	37,15
4765 19 0120	12	185	135	110	10	38,40
4765 19 0130	13	185	135	115	10	40,10
4765 19 0140	14	185	135	115	10	46,70

4770

Lokma Uçlu Tornavida (mm)
Nut Spinner (mm)

DIN 3125



Krom vanadyum, Krom kaplı, PP Saplı
Chrom vanadium, Chrom plated, PP insulated

KOD CODE	mm	L mm	L1 mm	g	TL/Ad.	
4770 19 0040	4	220	125	80	10	34,10
4770 19 0050	5	220	125	80	10	34,10
4770 19 0055	5.5	220	125	80	10	34,10
4770 19 0060	6	220	125	80	10	34,10
4770 19 0070	7	230	125	100	10	36,60
4770 19 0080	8	230	125	110	10	36,60
4770 19 0090	9	230	125	115	10	39,50
4770 19 0100	10	230	125	115	10	39,50
4770 19 0110	11	230	125	130	10	43,15
4770 19 0120	12	230	125	135	10	46,30
4770 19 0130	13	230	125	140	10	49,90
4770 19 0140	14	230	125	140	10	55,15

6

4772

Süngüsü İzoleli Lokma Uçlu Tornavida
Nut Spinner, Electrician Blade Insulated

DIN 3125

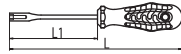

Krom vanadyum, PP saplı
Chrome vanadium, PP handle

KOD CODE	mm	L mm	L1 mm	g	TL/Ad.	
★4772 19 0040	4	220	125	90	10	46,40
★4772 19 0050	5	220	125	90	10	46,40
★4772 19 0060	6	220	125	90	10	46,40
★4772 19 0070	7	230	125	110	10	49,80
★4772 19 0080	8	230	125	120	10	49,80
★4772 19 0090	9	230	125	125	10	53,80
★4772 19 0100	10	230	125	125	10	53,80
★4772 19 0110	11	230	125	140	10	58,75
★4772 19 0120	12	230	125	145	10	63,15
★4772 19 0130	13	230	125	150	10	64,10
★4772 19 0140	14	230	125	150	10	75,10

4770

Lokma Uçlu Tornavida Seti (8 Parça, mm)
Nut Spinner Set (8 Pcs, mm)



KOD CODE	İÇERİK CONTENTS	g	TL/Ad.
4770 00 8108	6 - 7 - 8 - 9 - 10 11 - 12 - 13	2145	8 325,65

4773

1000V Süngüsü İzoleli Lokma Uçlu Tornavida
Nut Spinner, Electrician Blade Insulated 1000V

DIN 3125



Krom vanadyum, PP saplı
Chrome vanadium, PP handle

KOD CODE	mm	L mm	L1 mm	g		TL/Ad.
4773 19 0040	4	220	125	90	10	48,40
4773 19 0050	5	220	125	90	10	48,40
4773 19 0055	5.5	220	125	90	10	48,40
4773 19 0060	6	220	125	90	10	48,40
4773 19 0070	7	230	125	110	10	51,90
4773 19 0080	8	230	125	120	10	51,90
4773 19 0090	9	230	125	125	10	56,05
4773 19 0100	10	230	125	125	10	56,05
4773 19 0110	11	230	125	140	10	61,20
4773 19 0120	12	230	125	145	10	65,65
4773 19 0130	13	230	125	150	10	70,75
4773 19 0140	14	230	125	150	10	78,25

4773

1000V Süngüsü İzoleli Lokma Uçlu Tornavida Seti (8 Parça)
Nut Spinner, Electrician Blade Insulated Set (8 Pcs)
1000V



KOD CODE	İÇERİK CONTENTS	g		TL/Ad.
4773 00 8108	6 - 7 - 8 - 9 - 10 - 11 - 12 - 13	2225	8	461,90

4775

Torx® Uçlu Tornavida
Torx® Screwdriver

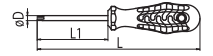

Krom vanadyum, Krom kaplı, Ucu siyah oksit, PP saplı
Chrome vanadium, Chrom plated and blackened, PP handle

KOD CODE	σDxL1 mm	★	L mm	g		TL/Ad.
4775 18 0010	4x80	T10	165	35	10	18,45
4775 18 0015	4x80	T15	165	35	10	18,45
4775 18 0020	4x100	T20	185	40	10	20,50
4775 18 0025	4.5x100	T25	185	40	10	23,75
4775 18 0027	5x125	T27	220	60	10	26,20
4775 18 0030	6x125	T30	220	70	10	27,80
4775 18 0040	7x125	T40	230	100	10	34,55
4775 18 0045	8x125	T45	230	120	10	39,05

6

4775

Torx® Uçlu Tornavida Seti (7 Parça)
Torx® Screwdriver Set (7 Pcs)



KOD CODE	İÇERİK CONTENTS	g		TL/Ad.
4775 00 8107	T10 - T15 - T20 - T25 - T27 - T30 - T40	380	7	169,70

4776

Delikli Torx® Uçlu Tornavida
Torx® Screwdriver / Tamper Resistance

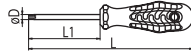

Krom vanadyum, Krom kaplı, Ucu siyah oksit, PP saplı
Chrome vanadium, Chrom plated and blackened, PP handle

KOD CODE	ØDxL1 mm	☆	L mm	g	□	TL/Ad.
4776 18 0009	4x60	TR9	145	35	10	22,30
4776 18 0010	4x80	TR10	165	35	10	23,00
4776 18 0015	4x80	TR15	165	40	10	23,00
4776 18 0020	4x100	TR20	185	40	10	25,70
4776 18 0025	4.5x100	TR25	185	45	10	29,65
4776 18 0027	5x125	TR27	220	60	10	32,75
4776 18 0030	6x125	TR30	220	70	10	34,80
4776 18 0040	7x125	TR40	230	100	10	43,15

4776

Delikli Torx® Uçlu Tornavida Seti (7 Parça)
Torx® Screwdriver / Tamper Resistance Set (7 Pcs)



KOD CODE	İÇERİK CONTENTS	g	□	TL/Ad.
4776 00 8107	TR10 - TR15 - TR20 - TR25 - TR27 TR30 - TR40	380	7	212,05

4780

Manyetik Bits Tutucu Tornavida (Uzun)
Screwdriver, Magnetic Bit Holder (Long)



KOD CODE	mm	L mm	L1 mm	g	□	TL/Ad.
4780 19 6120	6.3	230	120	105	10	40,00

4783

1000V Süngüsü İzoleli Manyetik Bits Tutucu Tornavida
Screwdriver, Magnetic Bit Holder Insulated
1000V

⚡ 1000 V
IEC 60900



KOD CODE	mm	L mm	L1 mm	g	□	TL/Ad.
4783 19 6120	6.3	230	120	115	10	52,05

4785

Manyetik Bits Tutucu Tornavida (Kısa)
Screwdriver, Magnetic Bit Holder, (Short)



KOD CODE	mm	L mm	L1 mm	g	□	TL/Ad.
4785 19 6330	6.3	130	30	60	10	22,90

4790

Üniversal Bits Adaptörü (Manyetik)
Screwdriver Universal Bit Holder (Magnetic)



KOD CODE	mm	mm	L mm	g	□	TL/Ad.
4790 26 6360	6.3	6.3	60	25	10	17,55

4795

T Tipi Manyetik Bits Tutucu Tornavida
Magnetic Bit Holder With T-Handle



KOD CODE	mm	L mm	L1 mm	g		TL/Ad.
4795 19 0010	6.3	185	130	60	10	44,80

4788

Manyetik Bits Tutucu Tornavida, Flexible
Screwdriver, Magnetic Bit Holder, Flexible



KOD CODE	mm	L mm	L1 mm	g		TL/Ad.
4788 19 6160	6.3	275	170	130	10	87,35

4805

Bits Uç Lokma Adaptörü (Makine Kullanımına Uygun)
Socket Adapter

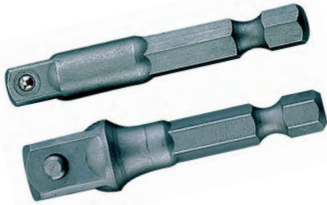

KOD CODE	mm	L mm	g		TL/Ad.
4805 20 5010	1/4"M - 1/4"M	50	20	10	7,50
4805 20 5011	1/4"M - 1/2"M	50	25	10	15,30

4815

Değişken Bits Uçlu Tornavida Set (7 parça)
Screwdriver - Interchangeable Bits Set (7 pcs)



KOD CODE	İÇERİK CONTENTS	g		TL/Ad.
4815 00 6107	100mm Sap Ph1x4.5 - Ph2x5.5 - Ph3x7 Pz1x4.5 - Pz2x5.5 - Pz3x7	140	1	44,60

4800

6'lı Bits Set
Bit Set (6 Pcs)



KOD CODE	İÇERİK CONTENTS	g		TL/Ad.
4800 00 8106	0.6x4.5 - 0.8x5.5 Ph1 - Ph2 - Ph3 T27	50	6	17,70

4800

10'lu Bits Set
Bit Set (10 Pcs)



KOD CODE	İÇERİK CONTENTS	g		TL/Ad.
4800 00 8110	0.6x4.5 - 0.8x5.5 1.2x6.5 Ph1 - Ph2 - Ph3 T25 - T27 - T30 - T40	55	10	32,85

4800

31'li Bits Takım (Plastik Kutulu)
Bit Set In Plastic Case
(31 Pcs)



KOD CODE	İÇERİK CONTENTS	g		TL/Ad.
4800 00 8131	0.6x4.5 - 0.8x5.5	385	6 - 6	3 - 3
	1.2x6.5			4
	Ph1			3
	Ph2 - Ph3			6 - 6
	T27			2
	T25 - T30 - T40			1-1-1
	6.3 x 60 Adaptör		1	106,05

(★) İşaretili olan ürünler stoklarla sınırlıdır.
Limited with stocks.

4810-4860

Düz Bits Uçlar

Bits Flat

25mm-50mm-75mm-100mm-150mm



Krom vanadyum
Chrom vanadium

4820-4870

Yıldız Bits Uçlar

Bits Phillips

25mm-50mm-75mm-100mm-150mm



Krom vanadyum
Chrom vanadium

6

KOD CODE	⊖	L mm	g	□	TL/Ad.
4810 20 0645	0.6x4.5	25	5	10	2,55
4810 20 0855	0.8x5.5	25	5	10	2,55
4810 20 1265	1.2x6.5	25	5	10	2,55
4810 20 5645	0.6x4.5	50	10	10	4,05
4810 20 5855	0.8x5.5	50	10	10	4,05
4810 20 5265	1.2x6.5	50	10	10	4,05
4860 20 0745	4.5	75	11	10	6,25
4860 20 0755	5.5	75	13	10	6,25
4860 20 0765	6.5	75	15	10	6,25
4860 20 1045	4.5	100	14	10	9,35
4860 20 1055	5.5	100	17	10	9,35
4860 20 1065	6.5	100	18	10	9,35
4860 20 1545	4.5	150	21	10	13,45
4860 20 1555	5.5	150	26	10	13,45
4860 20 1565	6.5	150	28	10	13,45

KOD CODE	⊕	L mm	g	□	TL/Ad.
4820 21 0001	Ph1	25	5	10	2,80
4820 21 0002	Ph2	25	5	10	2,80
4820 21 0003	Ph3	25	5	10	2,80
4820 21 0011	Ph1	50	10	10	4,20
4820 21 0012	Ph2	50	10	10	4,20
4820 21 0013	Ph3	50	10	10	4,20
4870 21 0701	Ph1	75	17	10	6,35
4870 21 0702	Ph2	75	18	10	6,35
4870 21 0703	Ph3	75	18	10	6,35
4870 21 1001	Ph1	100	20	10	9,70
4870 21 1002	Ph2	100	24	10	9,70
4870 21 1003	Ph3	100	24	10	9,70
4870 21 1501	Ph1	150	23	10	13,80
4870 21 1502	Ph2	150	33	10	13,80
4870 21 1503	Ph3	150	33	10	13,80

4810

Düz Bits Set (25 mm)

Flat Bit Set (25 mm)



KOD CODE	⊖	g	□	TL/Ad.
4810 00 0645	0.6x4.5	45	10	25,50
4810 00 0855	0.8x5.5	50	10	25,50
4810 00 1265	1.2x6.5	55	10	25,50

4820

Yıldız Bits Set (25 mm)

Phillips Bit Set (25 mm)



KOD CODE	⊕	g	□	TL/Ad.
4820 00 0001	Ph1	50	10	28,00
4820 00 0002	Ph2	50	10	28,00
4820 00 0003	Ph3	55	10	28,00

4825-4880

Pozidriv Bits Uçlar

Bits Pozidriv

25mm-50mm-75mm-100mm-150mm



Krom vanadyum
Chrom vanadium

KOD CODE	+	L mm	g	□	TL/Ad.
4825 21 0001	Pz1	25	5	10	3,00
4825 21 0002	Pz2	25	5	10	3,00
4825 21 0003	Pz3	25	5	10	3,00
4825 21 0011	Pz1	50	10	10	4,45
4825 21 0012	Pz2	50	10	10	4,45
4825 21 0013	Pz3	50	10	10	4,45
4880 21 0701	Pz1	75	17	10	6,45
4880 21 0702	Pz2	75	18	10	6,45
4880 21 0703	Pz3	75	18	10	6,45
4880 21 1001	Pz1	100	20	10	9,80
4880 21 1002	Pz2	100	24	10	9,80
4880 21 1003	Pz3	100	24	10	9,80
4880 21 1501	Pz1	150	23	10	14,10
4880 21 1502	Pz2	150	33	10	14,10
4880 21 1503	Pz3	150	33	10	14,10

4830-4885

Torx® Bits Uçlar

Bits Torx®

25mm-50mm-75mm-100mm-150mm



Krom vanadyum
Chrom vanadium

KOD CODE	+	L mm	g	□	TL/Ad.
4830 21 0025	T25	25	5	10	4,20
4830 21 0027	T27	25	5	10	4,20
4830 21 0030	T30	25	5	10	4,20
4830 21 0040	T40	25	5	10	4,20
4830 21 0125	T25	50	10	10	5,30
4830 21 0127	T27	50	10	10	5,30
4830 21 0130	T30	50	10	10	5,30
4830 21 0140	T40	50	10	10	5,30
4885 21 0725	T25	75	12	10	6,90
4885 21 0727	T27	75	15	10	6,90
4885 21 0730	T30	75	15	10	6,90
4885 21 0740	T40	75	17	10	6,90
4885 21 1025	T25	100	15	10	10,00
4885 21 1027	T27	100	20	10	10,00
4885 21 1030	T30	100	20	10	10,00
4885 21 1040	T40	100	23	10	10,00
4885 21 1525	T25	150	20	10	14,35
4885 21 1527	T27	150	25	10	14,35
4885 21 1530	T30	150	25	10	14,35
4885 21 1540	T40	150	33	10	14,35

6

4825

Pozidriv Bits Set (25 mm)

Pozidriv Bit Set (25 mm)



KOD CODE	+	g	□	TL/Ad.
4825 00 0001	Pz1	50	10	30,00
4825 00 0002	Pz2	55	10	30,00
4825 00 0003	Pz3	55	10	30,00

4830

Torx® Bits Set (25 mm)

Torx® Bit Set (25 mm)



KOD CODE	+	g	□	TL/Ad.
4830 00 0025	T25	50	10	42,00
4830 00 0027	T27	50	10	42,00
4830 00 0030	T30	55	10	42,00
4830 00 0040	T40	60	10	42,00

4850

75mm Uzun Bits Uç Takımı (13 Parça)
Bit Set, Long Type 75 mm (13 Pcs)

75mm

KOD CODE	İÇERİK CONTENTS	g	□	TL/Ad.
4850 00 0713	Düz Uçlar Flat Bits 4.5 - 5.5 - 6.5	204	13	84,75
	Yıldız Uçlar Phillips Bits Ph1 - Ph2 - Ph3			
	Pozidriv Uçlar Pozidriv Bits Pz1 - Pz2 - Pz3			
	Torx® Uçlar Torx® Bits T25 - T27 T30 - T40			

4850

150mm Uzun Bits Uç Takımı (13 Parça)
Bit Set, Long Type 150 mm (13 Pcs)

150mm

KOD CODE	İÇERİK CONTENTS	g	□	TL/Ad.
4850 00 1513	Düz Uçlar Flat Bits 4.5 - 5.5 - 6.5	356	13	181,45
	Yıldız Uçlar Phillips Bits Ph1 - Ph2 - Ph3			
	Pozidriv Uçlar Pozidriv Bits Pz1 - Pz2 - Pz3			
	Torx® Uçlar Torx® Bits T25 - T27 - T30 - T40			

6
4850

100mm Uzun Bits Uç Takımı (13 Parça)
Bit Set, Long Type 100 mm (13 Pcs)

100mm

KOD CODE	İÇERİK CONTENTS	g	□	TL/Ad.
4850 00 1013	Düz Uçlar Flat Bits 4.5 - 5.5 - 6.5	263	13	126,55
	Yıldız Uçlar Phillips Bits Ph1 - Ph2 - Ph3			
	Pozidriv Uçlar Pozidriv Bits Pz1 - Pz2 - Pz3			
	Torx® Uçlar Torx® Bits T25 - T27 - T30 - T40			



4900

Allen Anahtar Altı Köşe (mm) Hex Key Wrench (mm)

TS ISO 2936
DIN ISO 2936

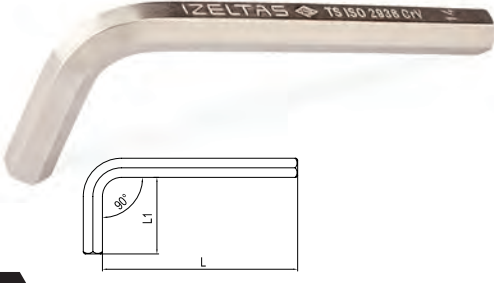

Krom Vanadyum, Nikel Kaplı
Chrom Vanadium, Nickel Plated

KOD CODE	mm	L mm	L1 mm	g	TL/Ad.	
4900 22 0015	1.5	45	14	1.5	10	1,70
4900 22 0020	2	50	16	2	10	2,00
4900 22 0025	2.5	56	18	4	10	2,45
4900 22 0030	3	63	20	6	10	2,70
4900 22 0035	3.5	66	22	8	10	3,35
4900 22 0040	4	70	25	10	10	3,45
4900 22 0050	5	80	28	20	10	4,00
4900 22 0060	6	90	32	30	10	5,30
4900 22 0070	7	95	34	40	10	7,85
4900 22 0080	8	100	36	55	10	8,25
4900 22 0090	9	105	38	75	10	10,20
4900 22 0100	10	112	40	100	10	12,60
4900 22 0120	12	125	45	160	10	16,10
4900 22 0140	14	140	56	250	5	27,60
4900 22 0160	16	152	60	375	5	51,00
4900 22 0170	17	160	63	425	5	55,00
4900 22 0190	19	180	70	610	5	68,00
4900 22 0220	22	200	80	940	5	105,95
4900 22 0240	24	224	90	1250	5	143,10

4900

Allen Anahtar Takım Altı Köşe (mm) Hex Key Wrench Set (mm)



KOD CODE	İÇERİK CONTENTS	g	TL/Ad.	
4900 00 3110	2 - 2.5 - 3 - 4 - 5 - 6 7 - 8 - 9 - 10	400	10	58,80
4900 00 3112	2 - 2.5 - 3 - 3.5 - 4 - 5 6 - 7 - 8 - 9 - 10 - 12	565	12	78,25

4901

Allen Anahtar Altı Köşe (SAE) Hex Key Wrench (SAE)

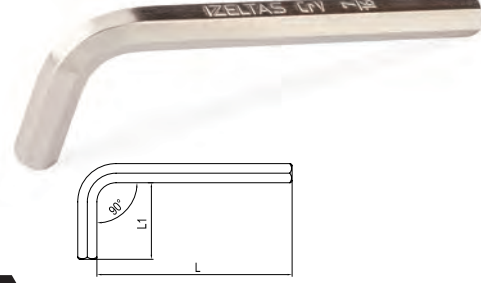

Krom Vanadyum, Nikel Kaplı
Chrom Vanadium, Nickel Plated

KOD CODE	inch	L mm	L1 mm	g	TL/Ad.	
4901 22 1984	5/64"	50	16	2	10	2,95
4901 22 2381	3/32"	54	18	4	10	3,20
4901 22 3125	1/8"	58	20	5	10	3,95
4901 22 3968	5/32"	62	22	10	10	4,80
4901 22 4762	3/16"	68	24	15	10	4,95
4901 22 5556	7/32"	74	26	25	10	6,65
4901 22 6350	1/4"	82	28	35	10	8,10
4901 22 7937	5/16"	94	32	55	10	10,10
4901 22 9825	3/8"	106	38	90	10	13,95
4901 22 1111	7/16"	118	42	130	10	18,80
4901 22 1270	1/2"	132	46	190	10	23,75
4901 22 1428	9/16"	144	52	265	10	34,60
4901 22 1587	5/8"	156	58	365	10	53,85
4901 22 1905	3/4"	176	66	600	5	75,40

4901

Allen Anahtar Takım Altı Köşe (SAE) Hex Key Wrench Set (SAE)



KOD CODE	İÇERİK CONTENTS	g	TL/Ad.	
4901 00 3110	5/64" - 3/32" - 1/8" - 5/32" 3/16" - 7/32" - 1/4" - 5/16" 3/8" - 7/16"	405	10	77,45
4901 00 3112	5/64" - 3/32" - 1/8" - 5/32" 3/16" - 7/32" - 1/4" - 5/16" 3/8" - 7/16" - 1/2" - 9/16"	855	12	135,80

(★) İşaretili olan ürünler stoklarla sınırlıdır.
Limited with stocks.

4903

Allen Anahtar Altı Köşe Uzun Boy (mm)
Hex Key Wrench Long Pattern (mm)

TS ISO 2936
DIN ISO 2936



Krom Vanadyum, Nikel Kaplı
Chrom Vanadium, Nickel Plated

KOD CODE	mm	L mm	L1 mm	g		TL/ Ad.
4903 22 0020	2	100	16	3	10	3,35
4903 22 0025	2.5	112	18	5	10	4,00
4903 22 0030	3	126	20	10	10	4,55
4903 22 0035	3.5	136.5	22	15	10	5,60
4903 22 0040	4	140	25	20	10	5,75
4903 22 0050	5	160	28	30	10	6,00
4903 22 0060	6	180	32	50	10	9,80
4903 22 0070	7	190	34	80	10	14,60
4903 22 0080	8	200	36	100	10	15,35
4903 22 0090	9	210	38	145	10	18,90
4903 22 0100	10	224	40	180	10	23,45
4903 22 0120	12	250	45	285	10	29,70
4903 22 0140	14	280	56	460	5	51,25
4903 22 0160	16	300	60	625	5	83,00
4903 22 0170	17	320	63	750	5	90,45
4903 22 0190	19	360	70	1100	5	134,00

4905

Yuvarlak Başlı Allen Anahtar (mm)
Hex Key Wrench Ballpoint (mm)



Krom Vanadyum, Nikel Kaplı
Chrom Vanadium, Nickel Plated

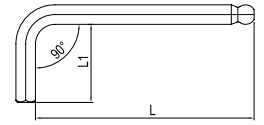

KOD CODE	mm	L mm	L1 mm	g		TL/ Ad.
4905 22 0020	2	50	16	3	10	3,50
4905 22 0025	2.5	56	18	4	10	4,20
4905 22 0030	3	63	20	5	10	4,80
4905 22 0040	4	70	25	10	10	6,00
4905 22 0050	5	80	28	20	10	6,30
4905 22 0060	6	90	32	30	10	9,45
4905 22 0080	8	100	36	55	10	14,60
4905 22 0100	10	112	40	100	10	22,45

4903

Allen Anahtar Takım Altı Köşe Uzun Boy (mm)
Hex Key Wrench Set Long Pattern (mm)



KOD CODE	İÇERİK CONTENTS	g		TL/Ad.
4903 00 3110	2 - 2.5 - 3 - 4 - 5 - 6 7 - 8 - 9 - 10	660	10	105,75
4903 00 3112	2 - 2.5 - 3 - 3.5 - 4 - 5 6 - 7 - 8 - 9 - 10 - 12	940	12	141,05

4905

Yuvarlak Başlı Allen Anahtar Takımı (8 Parça, mm)
Hex Key Wrench Ballpoint Set (8 Pcs, mm)



KOD CODE	İÇERİK CONTENTS	g		TL/Ad.
4905 00 7108	2 - 2.5 - 3 - 4 5 - 6 - 8 - 10	275	8	71,30

4906

Yuvarlak Başlı Allen Anahtar Uzun Boy (mm)
Hex Key Wrench Ballpoint Long Pattern (mm)

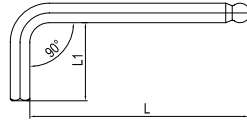

Krom Vanadyum, Nikel Kaplı
Chrom Vanadium, Nickel Plated

KOD CODE	mm	L mm	L1 mm	g	TL/Ad.	
4906 22 0015	1.5	79	12	1.5	10	4,65
4906 22 0020	2	84	16	3	10	6,25
4906 22 0025	2.5	89	16	5	10	6,75
4906 22 0030	3	99	18	7	10	7,35
4906 22 0040	4	109	23	13	10	8,35
4906 22 0050	5	125	26	25	10	10,55
4906 22 0060	6	150	28	42	10	12,10
4906 22 0080	8	167	33	85	10	18,00
4906 22 0100	10	190	37	150	10	25,85

4910

Torx® Allen Anahtar
Torx® Key Wrench

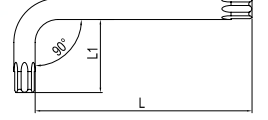

Krom Vanadyum, Nikel Kaplı
Chrom Vanadium, Nickel Plated

KOD CODE	★	L mm	L1 mm	g	TL/Ad.	
4910 22 0006	T6	42	16	2	10	14,05
4910 22 0007	T7	48	16	2	10	14,05
4910 22 0008	T8	48	16	3	10	14,05
4910 22 0009	T9	48	16	3	10	14,15
4910 22 0010	T10	51	17	4	10	14,15
4910 22 0015	T15	54	18	5	10	14,60
4910 22 0020	T20	57	19	5	10	15,25
4910 22 0025	T25	60	20	10	10	15,25
4910 22 0027	T27	64	21	15	10	15,25
4910 22 0030	T30	70	24	20	10	16,35
4910 22 0040	T40	76	26	30	10	17,40
4910 22 0045	T45	83	29	40	10	21,35
4910 22 0050	T50	95	32	60	10	24,35
4910 22 0055	T55	108	35	125	10	33,85
4910 22 0060	T60	120	38	185	10	46,65

4906

Yuvarlak Başlı Allen Anahtar Takım Altı Köşe Uzun Boy (9 parça, mm)
Hex Key Wrench Ballpoint Long Pattern Set (9 Pcs, mm)



KOD CODE	İÇERİK CONTENTS	g	TL/Ad.	
4906 00 3109	1.5 - 2 - 2.5 - 3 - 4 - 5 - 6 8 - 10	355	9	99,85

4910

Torx® Allen Anahtar Takımı (8 Parça)
Torx® Key Wrench Set (8 Pcs)

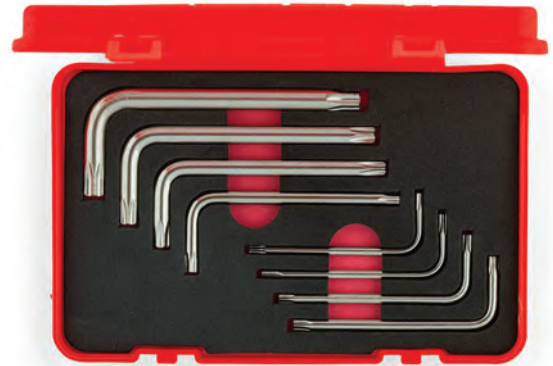

KOD CODE	İÇERİK CONTENTS	g	TL/Ad.	
4910 00 7108	T9 - T10 - T15 T20 - T25 - T27 T30 - T40	155	8	122,40

(★) İşaretili olan ürünler stoklarla sınırlıdır.
Limited with stocks.

4912

Kaset Allen Anahtar Takımı (7 Parça, mm)
Hex Key Wrench Folding Set (7 Pcs, mm)



6

Krom vanadyum
Chrom vanadium

KOD CODE	İÇERİK CONTENTS	g	TL/Ad.
4912 00 3107	2.5 - 3 - 4 - 5 - 6 - 8 - 10	355	1 110,00

4912

Kaset Allen Anahtar Takımı (7 Parça, mm)
Hex Key Wrench Folding Set (7 Pcs, mm)



Krom vanadyum
Chrom vanadium

KOD CODE	İÇERİK CONTENTS	g	TL/Ad.
4912 00 0007	1.5 - 2 - 2.5 - 3 - 4 - 5 - 6	130	1 74,00

4909

T Tipi Torx Allen Anahtar
T Handle Torx Key Wrench

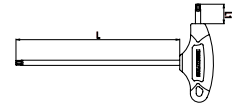

Krom vanadyum, Nikel kaplı, PP saplı
Chrom vanadium, Nickel plated, PP handle

KOD CODE	☆	L1 mm	L2 mm	g	TL/Ad.
4909 22 0009	T9	125	15	22	5 33,75
4909 22 0010	T10	125	15	22	5 34,40
4909 22 0015	T15	125	15	26	5 35,10
4909 22 0020	T20	125	15	44	5 35,40
4909 22 0025	T25	150	20	49	5 36,20
4909 22 0027	T27	150	20	62	5 40,25
4909 22 0030	T30	150	20	82	5 41,40
4909 22 0040	T40	175	25	100	5 42,95

4909

T Tipi Torx Allen Anahtar Takımı (8 Parça)
T Handle Torx Key Wrench Set (8 Pcs)



KOD CODE	İÇERİK CONTENTS	g	TL/Ad.
4909 00 8108	T9 - T10 - T15 - T20 T25 - T27 - T30 - T40	407	8 299,45

(★) İşaretli olan ürünler stoklarla sınırlıdır.
Limited with stocks.

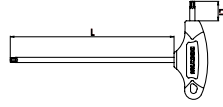
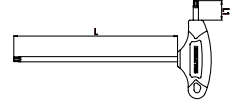
4920
T Tipi Allen Anahtar (mm)
Hex Key Wrench T - Handle (mm)

Krom Vanadyum
Chrom Vanadium
4921
Yuvarlak Başlı T Tipi Allen Anahtar (mm)
Hex Key Wrench T - Handle Ballpoint (mm)

Krom Vanadyum
Chrom Vanadium

KOD CODE	mm	L mm	L1 mm	g	TL/Ad.	
4920 22 0025	2.5	110	14	20	5	20,80
4920 22 0030	3	125	17	23	5	21,20
4920 22 0040	4	140	20	45	5	23,80
4920 22 0050	5	155	23	58	5	25,40
4920 22 0060	6	170	26	100	5	29,00
4920 22 0070	7	185	30	125	5	30,50
4920 22 0080	8	200	34	150	5	34,00
4920 22 0100	10	220	40	240	5	54,25

KOD CODE	mm	L mm	L1 mm	g	TL/Ad.	
4921 22 0025	2.5	110	14	20	5	27,00
4921 22 0030	3	125	17	23	5	27,35
4921 22 0040	4	140	20	45	5	30,75
4921 22 0050	5	155	23	58	5	33,00
4921 22 0060	6	170	26	100	5	37,70
4921 22 0070	7	185	30	125	5	39,50
4921 22 0080	8	200	34	150	5	42,50
4921 22 0100	10	220	40	235	5	70,50

6
4920
T Tipi Allen Anahtar Takımı (8 Parça, mm)
Hex Key Wrench T - Handle Set (8 Pcs, mm)

4921
Yuvarlak Başlı T Tipi Allen Anahtar Takımı (8 Parça, mm)
Hex Key Wrench T - Handle Ballpoint Set (8 Pcs, mm)

KOD CODE	İÇERİK CONTENTS	g	TL/Ad.	
4920 00 8108	2.5 - 3 - 4 - 5 6 - 7 - 8 - 10	760	8	238,95

KOD CODE	İÇERİK CONTENTS	g	TL/Ad.	
4921 00 8108	2.5 - 3 - 4 5 - 6 - 7 - 8 - 10	755	8	308,30

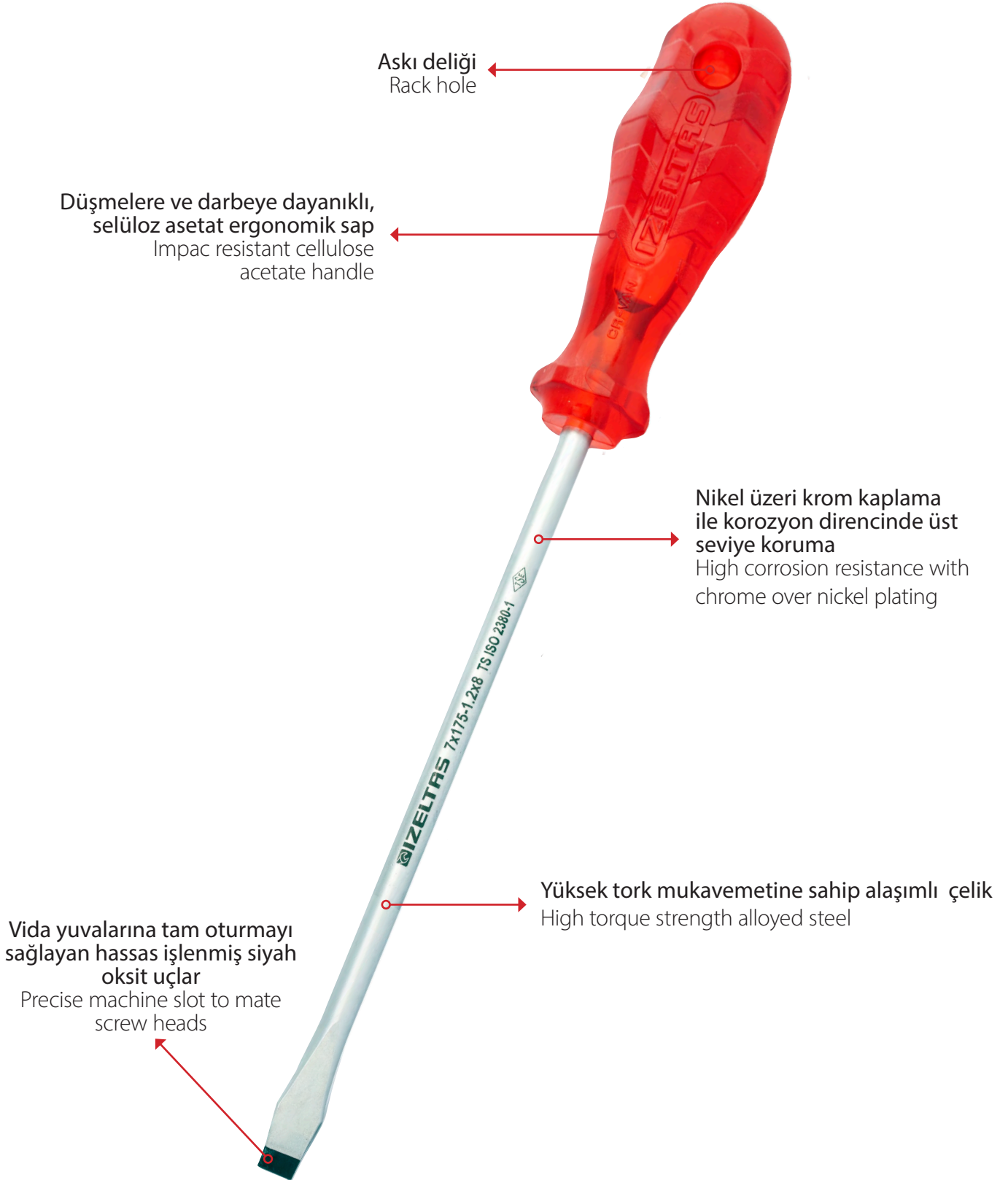

IZELTAS®

KESKİLER VE ÇEKİÇLER

CHISELS AND HAMMERS

Keskiler
Chisels

Zimbalar
Punches

Çekiçler
Hammers

Keserler
Adzes





Darbeyi eşit olarak dağıtmaya yarayan yuvarlak çelik kama
Steel wedge to equally distribute impact

İndüksiyonda sertleştirilmiş darbe yüzeyleri
Induction hardened impact surfaces

Sapın çıkmasını engelleyen epoksi yapıştırıcı
Epoxy glue to prevent handle separation

Yüksek karbonlu sıcak dövme çeliği ile arttırılmış dayanım
High carbon, hot forged steel

İndüksiyonda sertleştirilmiş darbe yüzeyleri
Induction hardened impact surfaces

Sap-gövde birleşiminden kırılmayı önleyen çelik yüzük
Steel bushing to prevent breakage at the head and handle connection area

Dışbudak ağacından üretilmiş, el ergonomisine uygun özel tasarımı, vernikli ahşap sap
Ergonomic special design handle produced from strong ash tree hardwood



5010

Iskarpela (Düz) Wood Chisel

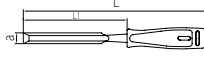

Özel alaşımli çelik, Uç indüksiyonda sertleştirilmiş, PP Saplı
Special steel, Induction hardened tips, PP Handle

KOD CODE	a mm	L mm	L1 mm	g	TL/Ad.	
5010 23 0006	6	245	153	115	5	36,50
5010 23 0008	8	245	153	125	5	39,00
5010 23 0010	10	245	153	135	5	41,25
5010 23 0012	12	245	153	135	5	45,25
5010 23 0014	14	245	153	145	5	46,80
5010 23 0016	16	255	153	150	5	50,05
5010 23 0018	18	255	153	160	5	54,30
5010 23 0020	20	255	153	170	5	60,40
5010 23 0022	22	255	153	190	5	65,45
5010 23 0024	24	255	153	195	5	70,70
5010 23 0026	26	255	153	200	5	73,25
★5010 23 0028	28	255	153	200	5	75,75
5010 23 0030	30	255	155	205	5	78,20

5010

Iskarpela Takım (6 parça) Wood Chisel Set (6 Pcs)



KOD CODE	İÇERİK CONTENTS	g	TL/Ad.	
5010 00 8106	10 - 12 - 14 16 - 18 - 20	985	6	298,05

5500

Düz Keski Flat Cold Chisel

TS 492
DIN 6453



Özel alaşımli çelik, Krom kaplı
Special steel, Chrom plated

KOD CODE	L mm	a mm	g	TL/Ad.	
5500 23 0100	100	17	75	5	23,20
5500 23 0125	125	19	110	5	27,90
5500 23 0150	150	21	180	5	35,90
5500 23 0175	175	24	245	5	40,50
5500 23 0200	200	27	340	5	56,40
5500 23 0250	250	30	525	5	69,40
5500 23 0300	300	30	635	5	111,20

5500

Düz Keski (Kalkan İzoleli) Flat Cold Chisel (With Safety Handle)

TS 492
DIN 6453

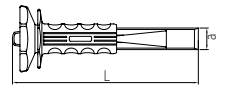

Özel alaşımli çelik, Krom kaplı
Special steel, Chrom plated

KOD CODE	L mm	a mm	g	TL/Ad.	
5500 23 1250	250	30	700	1	92,50
5500 23 1300	300	30	790	1	134,90

(★) İşaretili olan ürünler stoklarla sınırlıdır.
Limited with stocks.

5510

Tesviyeci Düz Keski
Flat Cold Chisel Octagonal

TS 492
DIN 6453

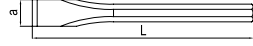

Krom vanadyum, Krom kaplı
Chrom vanadium, Chrom plated

KOD CODE	L mm	a mm	g	TL/Ad.
5510 23 0125	125	10	75	10 31,80
5510 23 0150	150	14	125	10 39,75

5520

Tırnak Keski
Cross Cut Chisel



Krom vanadyum, Krom kaplı
Chrom vanadium, Chrom plated

KOD CODE	L mm	a mm	g	TL/Ad.
5520 23 0125	130	5	70	10 35,65
5520 23 0150	150	6	110	10 42,50

5540

Nokta Zimba
Center Punch

DIN 7250

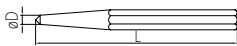

Krom vanadyum, Elektrostatik boyanmış
Chrom vanadium, Electrostatically painted

KOD CODE	L mm	L inch	øD mm	g	TL/Ad.
5540 24 4120	120	4 3/4"	4	65	10 24,55
5540 24 5120	120	4 3/4"	5	95	10 26,50
5540 24 5150	150	6"	5	115	10 32,00
★5540 24 0412	120	4 3/4"	4	65	10 24,25

★ Krom Kaplı / Chrom Plated

5545

Konik Pim Zimba
Drift Punch

DIN 6458

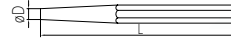

Krom vanadyum, Elektrostatik boyanmış
Chrom vanadium, Electrostatically painted

KOD CODE	L mm	L inch	øD mm	g	TL/Ad.
5545 24 0002	120	4 3/4"	2	90	10 21,90
5545 24 0003	120	4 3/4"	3	90	10 23,80
5545 24 0004	120	4 3/4"	4	90	10 26,80
5545 24 0005	120	4 3/4"	5	95	10 27,35
5545 24 0006	120	4 3/4"	6	95	10 40,35
5545 24 0007	120	6"	7	100	10 42,00
5545 24 0008	150	6"	8	125	10 43,65
5545 24 0009	150	6"	9	130	10 44,65
5545 24 0010	150	6"	10	130	10 45,55
5545 24 0012	150	6"	12	180	10 47,60
★5545 24 0103	120	4 3/4"	3	90	10 24,90

5550

Düz Pim Zimba
Split Pin Punch

DIN 6450

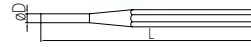

Krom vanadyum, Elektrostatik boyanmış
Chrom vanadium, Electrostatically painted

KOD CODE	L mm	L inch	øD mm	g	TL/Ad.
5550 24 0002	150	6"	2	70	5 29,25
5550 24 0003	150	6"	3	65	5 29,25
5550 24 0004	150	6"	4	65	5 29,75
5550 24 0005	150	6"	5	65	5 29,75
5550 24 0006	150	6"	6	70	5 30,00
5550 24 0007	150	6"	7	100	5 31,25
5550 24 0008	150	6"	8	105	5 33,45
5550 24 0009	150	6"	9	110	5 33,95
5550 24 0010	150	6"	10	120	5 34,25
★5550 24 0105	150	6"	5	65	5 28,00

5550

Düz Pim Zimba Takımı (6 Parça)
Split Pin Punch (6 Pcs)



KOD CODE	İÇERİK CONTENTS	g	TL/Ad.
5550 00 1006	3 - 4 - 5 - 6 - 7 - 8	865	6 223,00

(★) İşaretili olan ürünler stoklarla sınırlıdır.
Limited with stocks.

5600

Keski Zimba Takımı Chisel And Punch Set



KOD CODE	İÇERİK CONTENTS	g	TL/Ad.
5600 00 6106	125 Tevsiyeci Düz Keski 125 Flat Cold Chisel Octagonal	865	6
	150 Tevsiyeci Düz Keski 150 Flat Cold Chisel Octagonal		
	130 Tırnak Keski 130 Cross Cut Chisel		
	4x120 Nokta Zimba 4x120 Center Punch		
	5x150 Düz Pim Zimba 5x150 Split PinPunch		
	3x120 Konik Pim Zimba 3x120 Drift Punch		
			215,00

5700

Kayış Zimba Belt Punch

DIN 7200



Krom vanadyum, Elektrostatik boyanmış
Chrom vanadium, Electrostatically painted

KOD CODE	ØD mm	L mm	g	TL/Ad.	
★5700 24 1021	21	150	250	5	82,00
★5700 24 1022	22	150	260	5	83,10
★5700 24 1023	23	160	305	5	84,35
★5700 24 1024	24	160	320	5	89,85
★5700 24 1025	25	170	365	5	94,55
★5700 24 1026	26	170	355	5	99,70
★5700 24 1029	29	190	465	5	113,25
★5700 24 1030	30	190	475	5	114,85
★5700 24 1032	32	190	500	5	121,50

5700

Kayış Zimba Belt Punch

DIN 7200

TSEK

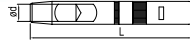

Krom vanadyum, Elektrostatik boyanmış
Chrom vanadium, Electrostatically painted

KOD CODE	ØD mm	L mm	g	TL/Ad.	
5700 24 0003	3	105	35	10	19,65
5700 24 0004	4	105	40	10	20,55
5700 24 0005	5	110	50	10	22,35
5700 24 0006	6	110	60	10	22,75
5700 24 0007	7	115	75	10	25,05
5700 24 0008	8	115	90	10	26,65
5700 24 0009	9	120	100	10	29,75
5700 24 0010	10	120	110	10	31,65
5700 24 0011	11	125	130	5	34,05
5700 24 0012	12	125	165	5	40,80
5700 24 0013	13	130	165	5	42,95
5700 24 0014	14	130	180	5	47,15
5700 24 0015	15	135	245	5	54,10
5700 24 0016	16	135	300	5	59,25
5700 24 0017	17	140	365	5	64,80
5700 24 0018	18	140	380	5	70,70
5700 24 0019	19	145	405	5	76,85
5700 24 0020	20	145	450	5	81,85

5700

Kayış Zimba Takımı Belt Punch Set



KOD CODE	İÇERİK CONTENTS	g	TL/Ad.	
5700 00 2110	3 - 4 - 5 - 6 - 7 8 - 9 - 10 - 11 - 12	845	10	273,25
5700 00 2112	3 - 4 - 5 - 6 - 7 - 8 - 9 10 - 11 - 12 - 13 - 14	1180	12	363,35

(★) İşaretili olan ürünler stoklarla sınırlıdır.
Limited with stocks.

5800

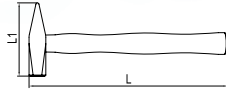

Tesviyeci Çekiç
Machinist Hammer

TS 5-1
DIN 1041

 **Yedek parça sayfa 197**
Spare parts page 197

Özel alaşımlı çelik, İndüksiyonda sertleştirilmiş, Elektrostatik boyanmış
Special steel, Induction hardened, Electrostatically painted

KOD CODE	L mm	L1 mm	 g	 g		TL/Ad.
5800 25 0100	260	82	100	160	10	45,00
5800 25 0200	280	95	200	260	10	49,00
5800 25 0300	300	105	300	395	10	49,50
5800 25 0500	320	118	500	600	5	68,75
5800 25 1000	360	135	1000	1095	5	96,00
5800 25 1500	380	145	1500	1630	5	130,50
5800 25 2000	400	155	2000	2100	5	160,50

5850

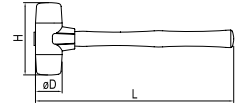

Plastik Çekiç
Plastic Hammer

TS 5

 **Yedek parça sayfa 197**
Spare parts page 197

Darbeye dayanıklı, Kolay değiştirilebilir başlık
Durable and easily changeable heads

KOD CODE	L mm	øD mm	H mm	 g		TL/Ad.
5850 25 0030	300	30	100	345	5	60,85
5850 25 0040	320	40	110	645	5	74,05
5850 25 0050	350	50	120	1015	5	92,55

7



5810

Emniyet Çekici
Safety Hammer

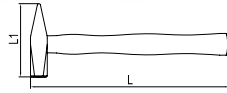
TS 5-1



Özel alaşımlı çelik, İndüksiyonda sertleştirilmiş, Elektrostatik boyanmış
Special steel, Induction hardened, Electrostatically painted

KOD CODE	L mm	L1 mm	 g	 g		TL/Ad.
5810 25 1000	260	135	1000	1095	5	129,60
5810 25 1500	280	145	1500	1630	5	179,35
5810 25 2000	400	155	2000	2100	5	221,50

Emniyet çekici

Çekiç kafası ile sapın birleşiminde yuvarlak kama ve yapışkan malzeme kullanılarak sağlamlığı artırılmış ayrıca birleşimi çelik sac malzeme ile desteklenerek güvenli kullanım sağlanmıştır.

Safety Hammer

Connection between the hammer head and the handle is ensured by circular wedge and epoxy glue, while it is also reinforced by sheet metal for safe use.

5870

Lastik Çekiç
Rubber Hammer

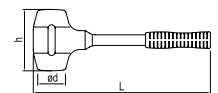

KOD CODE	L mm	øD mm	h mm	 g	 g		TL/Ad.
5870 25 0400	300	47	104	400	610	5	113,25

(*) İşareti olan ürünler stoklarla sınırlıdır.
Limited with stocks.

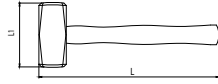
5865
Madırğa
Mallet

Yedek parça sayfa 197
Spare parts page 197
Özel alaşımli çelik
Special steel

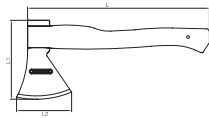
KOD CODE	L mm	L1 mm		g		TL/Ad.
5865 25 1000	260	95	1000	1210	5	118,70
5865 25 1500	280	110	1500	1770	5	141,85

6410
Nacak
Hatchet

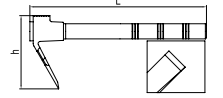
Yedek parça sayfa 197
Spare parts page 197
Özel alaşımli çelik, İndüksiyonda sertleştirilmiş, Elektrostatik boyanmış
Special steel, Induction hardened, Electrostatically painted

KOD CODE	L mm	L1 mm	L2 mm	g	g		TL/Ad.
6410 25 0800	380	165	115	800	1065	1	206,20

6400
Keser
Adze

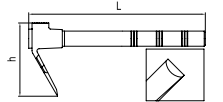
Yedek parça sayfa 197
Spare parts page 197
Özel alaşımli çelik, İndüksiyonda sertleştirilmiş, Elektrostatik boyanmış, PVC ağız koruyucu
Special steel, Induction hardened, Electrostatically painted, PVC cutting edge protector

KOD CODE	L mm	h mm	g	g		TL/Ad.
6400 25 0600	400	125	400	550	5	124,65

6401
Usta Keseri
Master Adze

Yedek parça sayfa 197
Spare parts page 197
Özel alaşımli çelik, İndüksiyonda sertleştirilmiş, Elektrostatik boyanmış, PVC ağız koruyucu
Special steel, Induction hardened, Electrostatically painted, PVC cutting edge protector

KOD CODE	L mm	h mm	g	g		TL/Ad.
6401 25 0600	400	125	400	540	5	124,65

7



ZELTAS

DIN 8131

5232

INDUCTION
HARDENED

800 GR.

8410



ZELTAS

IZELTAS®

SERVİS ALET VE EKİPMANLARI

MAINTANCE TOOLS AND EQUIPMENT

Servis Aletleri
Service Equipment

Perçin Tabancası
Riveting Pliers

İşkenceler
Clamps

İnşaat Ekipmanları
Construction Equipment

Metreler
Measuring Tapes

Mengene
Forged Steel Vice

Su Terazisi
Straight Level

Gres Pompası
Grease Gun



KABLO SIYIRICI (KANCA BIÇAKLI) / CABLE STRIPPER (WITH HOOKED BLADE)

Tüm standart kabloları sıyırmak için daha uzun ömür, daha hızlı kesme ve daha az aşınma sağlayan özel titanyum nitrür (TIN) kaplama
Tin plated long lasting/ fast cutting blade to strip all standard cables

Özel alışılmış çelikten sertleştirilmiş ve kaplanmış kanca bıçak
Plated special alloy hardened steel hook blade

Kapasite 8-28mm çaplı kablolar için uygun
Suitable for 8-28mm diameter cables

Özel kaydırmaz formu dayanıklı polyamid (PA) sap
Non-slip and durable polyamid handle

Çevirerek kolay bıçak yükseklik ayarı
Easy-to-rotate blade height adjuster

03750

Kablo Sıyrıcı (Kancalı Bıçaklı)
Cable Stripper (With Hooked Blade)



 Yedek parça sayfa 197
Spare parts page 197

KOD CODE	ÖLÇÜ SIZE	g	□	TL/Ad.
03750 50 020	Ø8-28	79	5	78,25

03753

Mekanik Kablo Sıyrıcı
Mechanical Cable Stripper



KOD CODE	ÖLÇÜ SIZE	g	□	TL/Ad.
03753 50 054	0.5/4	100	5	133,85

03752

Kablo Sıyrıcı
Cable Stripper



 Yedek parça sayfa 197
Spare parts page 197

KOD CODE	ÖLÇÜ SIZE	g	□	TL/Ad.
03752 50 625	Tek 6/300 Çok 1.5/25	70	5	71,15

03751

Koaksiyel Kablo Sıyrıcı
Coaxial Cable Stripper



KOD CODE	ÖLÇÜ SIZE	g	□	TL/Ad.
03751 50 012	Dış (1) İç (2)	20	5	101,55

05881

Krom Şerit Metre
Chrom Steel Case, Measuring tapes



KOD CODE	ÖLÇÜ SIZE M	g	MODEL	□	TL/Ad.
05881 50 013	3	160	Krom/Chrom	5	36,70
05881 50 015	5	220	Krom/Chrom	5	41,45

05881

Plastik Şerit Metre
Plastic Steel Case, Measuring tapes



KOD CODE	ÖLÇÜ SIZE M	g	MODEL	□	TL/Ad.
05881 50 003	3	145	Plastik/Plastic	5	30,80
05881 50 005	5	200	Plastik/Plastic	5	37,00

05886

Arazi Tipi Fiberglas Şerit Metre (Saplı)
Fiberglass Measuring Tape Field Type (With Holder)



KOD CODE	ÖLÇÜ SIZE M	g		TL/Ad.
05886 50 020	20	520	1	82,15
05886 50 030	30	585	1	87,70
05886 50 050	50	820	1	140,95

05880

Su Terazisi
Straight Level



Alüminyum gövde
Aluminium body

KOD CODE	L mm	g		TL/Ad.
05880 50 040	400	250	5	78,90
05880 50 050	500	300	5	85,65
05880 50 060	600	350	5	93,05
05880 50 070	700	400	5	99,95
05880 50 080	800	450	5	107,95
05880 50 100	1000	500	5	122,90
05880 50 120	1200	550	5	145,45
05880 50 150	1500	600	5	167,60
05880 50 200	2000	800	5	234,15

05887

Kumpas
Vernier



Sürgülü, Stoplu
Sliding and with stop

KOD CODE	L mm	g		TL/Ad.
05887 50 150	150	155	5	291,30

05890

Testere Kolu
Hacksaw Frame



Yedek parça sayfa 198
Spare parts page 198

KOD CODE	L mm	g		TL/Ad.
05890 50 830	300	540	5	116,20

6735

Dal Budama Testeresi
Pruning Saw



Yedek parça sayfa 198
Spare parts page 198

KOD CODE	L mm	g		TL/Ad.
6735 27 0300	300	400	5	124,70

05895

Kıl Testere Kolu (Ağaç saplı)
Hacksaw Frame (Wooden Handle)



KOD CODE	L mm	g		TL/Ad.
05895 50 150	150	95	10	25,25

05901

Sentil (20 Parça, mm)
Feeler Gauges (20 Pcs, mm)



KOD CODE	ÖLÇÜ SIZE mm	g		TL/Ad.
05901 50 020	0.05 - 1	90	10	28,20

6195

Perçin Tabancası
Riveting Pliers



KOD CODE	ÖLÇÜ SIZE	CAPACITY mm	g		TL/Ad.
6195 26 0260	260	2.5 - 3.2 - 4 - 4.8	625	1	144,45

05902

Sentil (20 Parça, SAE)
Feeler Gauges (20 Pcs, SAE)



KOD CODE	ÖLÇÜ SIZE inch	g		TL/Ad.
05902 50 020	2 - 35/1000"	65	10	44,10

6220

Spiralli Mıknatıs
Flexible Magnet Holder

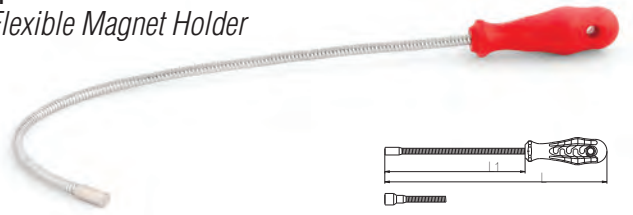

KOD CODE	ÖLÇÜ	L mm	L1 mm	g		TL/Ad.
6220 26 0500	500	465	375	100	10	77,10
6220 26 1000	1000	465	375	105	10	81,65

6225

Madeni Yağdanlık (Flexible Uçlu)
Oiler With Flexible Spout



KOD CODE	ÖLÇÜ SIZE cc	g		TL/Ad.
6225 26 0200	200	170	5	49,95
6225 26 0300	300	200	5	56,20
6225 26 0500	500	225	5	61,70

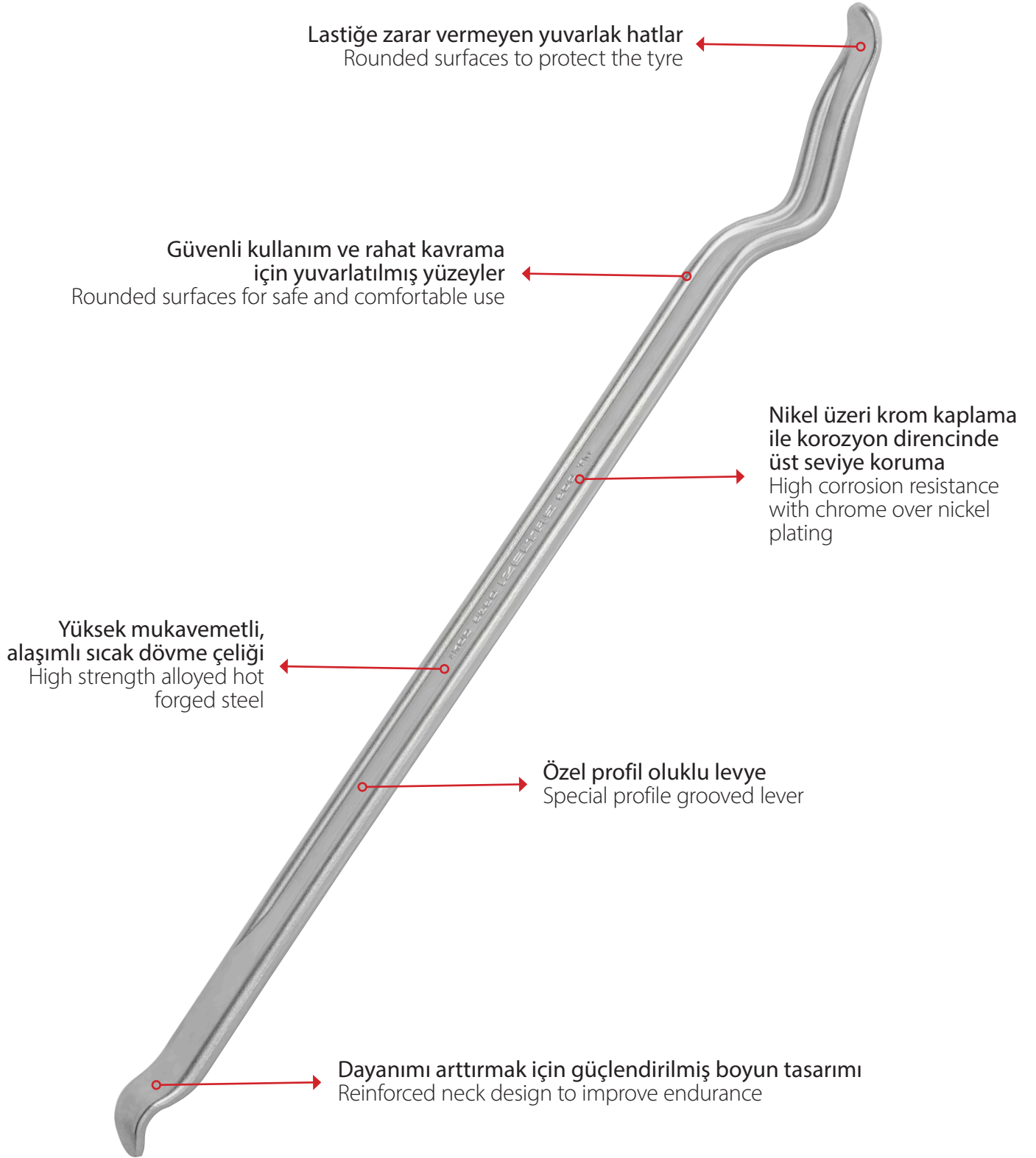

6230

Gres Pompası
Grease Gun



 Yedek parça sayfa 198
Spare parts page 198

KOD CODE	ÖLÇÜ SIZE cc	g		TL/Ad.
6230 26 0300	300	1200	1	86,70
6230 26 0500	500	1320	1	101,70

6235

Süba Ayar Tornavidası
Valve Adjustment Spinner



KOD CODE	L mm	g		TL/Ad.
★6235 19 0220	220	90	10	31,25

6240

Tapa Anahtarı (iki ağız)
Offset Wrench For Carter Case



KOD CODE	ÖLÇÜ mm	g		TL/Ad.
6240 26 0810	8x10	250	10	45,65

6350

Levye Oluklu
Tyre Lever, Straight



TSEK

Krom vanadyum, Krom kaplı
Chrom vanadium, Chrom plated

KOD CODE	L mm	L inch	g		TL/Ad.
6350 26 0300	300	12"	265	5	34,65
6350 26 0400	400	16"	440	5	47,50
6350 26 0500	500	20"	675	5	66,10
6350 26 0600	600	24"	900	5	80,70

6360

Levye Oluklu Kıvrık Uçlu
Tyre Lever, Bent

TSEK



Krom vanadyum, Krom kaplı
Chrom vanadium, Chrom plated

KOD CODE	L mm	L inch	g		TL/Ad.
6360 26 0600	600	24"	910	5	93,25

6370

Yağ Filtresi Sökeceği
Band Type Oil Filter Wrench



KOD CODE	Ø mm	g		TL/Ad.
6370 26 0100	75 - 100	335	5	45,15

8

6371

Üç Ayaklı Yağ Filtresi Sökeceği
Oil Filter Hook 3 Arms Pattern



KOD CODE	Ø mm	g		TL/Ad.
★6371 26 3120	63 - 120	700	5	129,25

6375

Çift Yönlü Üç Ayaklı Yağ Filtresi Sökeceği
Left and Right Hand Operation, Triple Leg Oil Filter Wrench



3/8" - 1/2"

KOD CODE	L mm	g	TL/Ad.
6375 26 6512	75-120	603	5 182,40

06374

Zincirli Yağ Filtresi Sökeceği
Chain Wrench



KOD CODE	Ø mm	g	TL/Ad.
06374 50 140	60x140	390	5 111,30

6380

Çift Zincirli Yağ Filtresi Sökeceği
Oil Filter Wrench With Double Chain



06375

Ayarlı Yağ Filtresi Sökeceği
Adjustable Slot Type Oil Filter Wrench



Yedek parça sayfa 197
Spare parts page 197

KOD CODE	L mm	g	TL/Ad.
6380 26 6016	60-160	380	5 550,50

KOD CODE	Ø mm	g	TL/Ad.
06375 50 100	100	215	5 54,25

06373

Kayıslı Yağ Filtresi Sökeceği
Strap Wrench



06376

Sac Yağ Filtresi Sökeceği
Oil Filter Wrench



KOD CODE	Ø mm	g	TL/Ad.
06373 50 140	60x140	245	5 138,45

KOD CODE	Ø mm	inch	g	TL/Ad.
★06376 50 108	108	3/8"	240	5 45,15

06390

Segman Çemberi
Piston Ring Compressor



KOD CODE	Ø mm	g	□	TL/Ad.
06390 50 125	125	235	5	110,20
06390 50 175	175	505	5	225,25

07415

Sıralı Tel Fırça (Ağaç Saplı)
Hand Brush (Wooden Handle)



KOD CODE	ÖLÇÜ SIZE	g	□	TL/Ad.
07415 50 003	3 SIRA 3 RAWS	125	5	10,80
07415 50 004	4 SIRA 4 RAWS	135	5	11,45
07415 50 005	5 SIRA 5 RAWS	145	5	12,75
07415 50 006	6 SIRA 6 RAWS	170	5	13,65

07416

Kıvrık Uçlu Fırça (Plastik Saplı)
Hand Brush (PP Handle)



KOD CODE	ÖLÇÜ SIZE	g	□	TL/Ad.
07416 50 001	270	110	5	14,60

07410

Makaralı Uzatma Kablosu
Extension Cord Reel



Kablo / Cable ø 3x1.5 mm

KOD CODE	MODEL	ÖLÇÜ SIZE	g	□	TL/Ad.
07410 50 010	el tipi / with handle	10	1400	1	233,40

07410

Makaralı Uzatma Kablosu
Extension Cord Reel



Kablo / Cable ø 3x1.5 mm

KOD CODE	MODEL	ÖLÇÜ SIZE	g	□	TL/Ad.
07410 50 025	ayaklı / with stand	25	4130	1	500,55
07410 50 050	ayaklı / with stand	50	6745	1	700,70

8



(*) İşaretili olan ürünler stoklarla sınırlıdır.
Limited with stocks.

DÖVME ÇELİK MENGENE/TFORGED STEEL VICE WITH SWIVEL BASE

Isıl işlem sonrasında ilave olarak yapılan
indüksiyonda sertleştirme işlemi ile güçlü
tutuş sağlayan özel profilli çeneler
Heat treated and induction hardened special
profile jaws for powerful grip

İndüksiyonda
sertleştirme ile
kullanım ömrü
arttırılmış, korozyona
karşı çinko ile
kaplanmış ilerleme mili
High strength alloyed
steel. High corrosion
protection with chrome
over nickel plating

İndüksiyonda
sertleştirilmiş darbeye
dayanıklı yüzeyler
Induction hardened
impact resistant surfaces

Yüksek
karbonlu sıcak
dövme çeliği ile
arttırılmış dayanım
Improved lifetime
with hot forged high
carbon steel

Elektrostatik fırın
boya ile korozyon
direnci sağlanmış
yüzeyler
High corrosion
resistance with
electrostatic
powder paint

Yüksek mukavemetli,
alaşımli çelik
Nikel üzerine krom
kaplama ile sağlanan,
korozyon direncinde
üst seviye koruma
High strength alloyed
steel. High corrosion
protection with chrome
over nickel plating

Çevirme kolunun
yerinden çıkmaması
için kullanılan
kauçuklar
Rubber stoppers to keep
the bar on the spindle

Çelik döküm
mengene altlığı
Cast steel base plate

Mengenenin 360°
dönmesini sağlayan
çelik döner parça
Vice plate for 360°
rotation

İlerleme mili
koruma sacı
Protective cover
screw spindle

7401

Mengene Döner Tablası Swivel Base of Vice

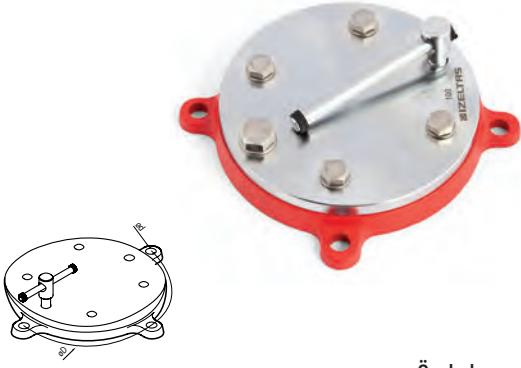

Özel alaşım çelik, Krom kaplı
Special steel, Chrom plated

KOD CODE	ÖLÇÜ SIZE	σd mm	σD mm	g	□	TL/Ad.
7401 30 0100	100	10.5	170	1550	1	198,95
7401 30 0125	125	12.5	200	2700	1	262,90
7401 30 0150	150	12.5	240	3800	1	319,15
7401 30 0175	175	12.5	280	6650	1	360,85

7400

Dövme Çelik Mengene Forged Steel Vice

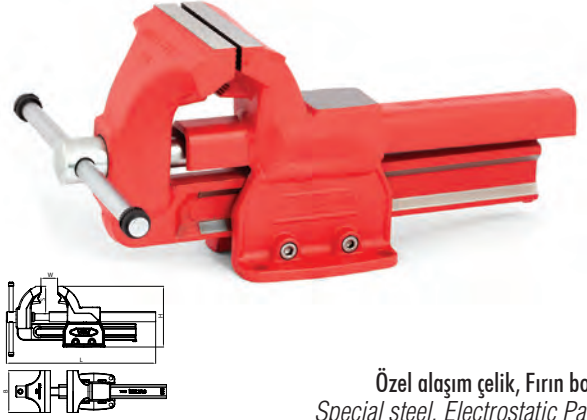

Özel alaşım çelik, Fırın boya
Special steel, Electrostatic Paint

KOD CODE	B mm	W mm	H mm	L mm	g	□	TL/Ad.
7400 30 0100	100	125	148	440	5000	1	675,90
7400 30 0125	125	155	183	550	11000	1	930,50
7400 30 0150	150	180	220	675	20000	1	1190,10
7400 30 0175	175	205	245	760	29000	1	1464,30

7400

Dövme Çelik Mengene (Döner Tabla dahil) Forged Steel Vice with Swivel Base



Özel alaşım çelik, Fırın boya
Special steel, Electrostatic Paint

KOD CODE	B mm	g	□	TL/Ad.
7400 00 0100	100	6550	1	874,75
7400 00 0125	125	13700	1	1193,45
7400 00 0150	150	23800	1	1509,25
7400 00 0175	175	35650	1	1825,05

7300

İşkence (Marangoz Mengenesi Plastik Ağızlı)
Carpenter Screw Clamp



Darbeye dayanıklı çeneler
Impact resistant cast iron jaws

KOD CODE		a mm	b mm			TL/Ad.
7300 30 3012	30x12	300	120	1605	5	140,25
7300 30 4012	40x12	400	120	1780	5	177,50
7300 30 5012	50x12	500	120	1935	5	182,00
7300 30 6012	60x12	600	120	2080	5	190,00
7300 30 8012	80x12	800	120	2470	5	201,50
7300 30 1012	100x12	1000	120	2790	5	230,00

7310

Mini İşkence
Mini Clamp



Alaşımlı alüminyum çeneler
Alloyed aluminum jaws

KOD CODE		a mm	b mm			TL/Ad.
7310 30 1005	10x5	100	50	250	5	61,70
7310 30 1505	15x5	150	50	280	5	65,05
7310 30 2005	20x5	200	50	310	5	67,40
7310 30 2505	25x5	250	50	330	5	70,30
7310 30 3005	30x5	300	50	360	5	72,80

8



IZELTAS®

MAKASLAR

SHEARS

Demir Kesme Makası
Bolt Cutters

Saç Makasları
Sheet Metal Cutters

Plastik Boru Kesme Makası
Plastic Pipe Cutters

Bağ Makasları
Prunnig Shears



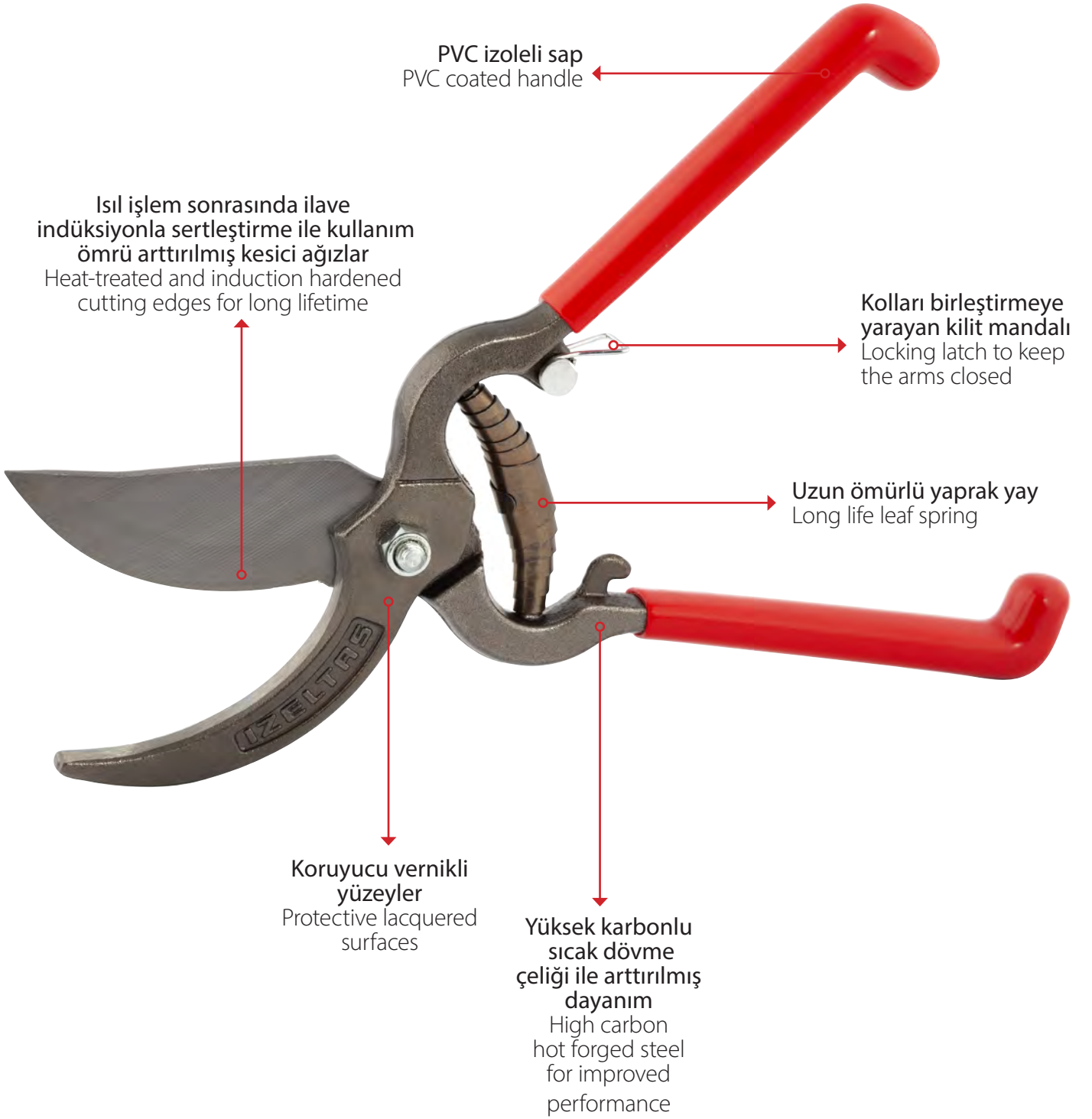

2350

Demir Kesme Makası Bolt Cutters



Yedek parça sayfa 196
Spare parts page 196

Özel alaşımli çelik, Kesici ağızlar induksiyonda sertleştirilmiş,
Elektrostatik boyanmış çeneler ve bağlantı parçaları dövme
Special steel, Cutters induction hardened,
Electrostatically painted jaws and connection parts drop forged

KOD CODE	L mm	L inch	KAPASİTE CAPACITY Ø mm	g	TL/Ad.
2350 27 0018	450	18"	6 - 8	1510	321,05
2350 27 0024	600	24"	8 - 10	2350	472,60
2350 27 0030	750	30"	9 - 13	3750	740,00
2350 27 0036	900	36"	11 - 16	5500	957,65

2350

Demir Kesme Makası Sehpa Bolt Cutters Frame



KOD CODE	İÇERİK CONTENTS	g	TL/Ad.
2350 00 6104	18"(450) - 24"(600) 30"(750) - 36"(900)	21.110	2991,30

6205

Alüminyum Ve Sac Kesme Makası Sağ Snip For Aluminum and Metal Sheet (Right)



Özel alaşımli çelik, Kesici ağızlar induksiyonda sertleştirilmiş,
Special steel, Cutters induction hardened,

KOD CODE	L mm	L inch	g	TL/Ad.
6205 27 0240	240	10"	380	96,30

6206

Alüminyum Ve Sac Kesme Makası Sol Snip For Aluminum and Metal Sheet (Left)



Özel alaşımli çelik, Kesici ağızlar induksiyonda sertleştirilmiş
Special steel, Cutters induction hardened

KOD CODE	L mm	L inch	g	TL/Ad.
6206 27 0240	240	10"	380	96,30

6207

Alüminyum Ve Sac Kesme Makası Düz Snip For Aluminum and Metal Sheet (Flat)



Özel alaşımli çelik, Kesici ağızlar induksiyonda sertleştirilmiş
Special steel, Cutters induction hardened

KOD CODE	L mm	L inch	g	TL/Ad.
6207 27 0240	240	10"	380	96,30

6210**Kaportacı Makası (Sağ)**
Punch Snip (Right)

DIN 6438



Özel alaşımlı çelik, Kesici ağızlar indüksiyonda sertleştirilmiş, PVC izoleli
Special steel, Cutters induction hardened, PVC insulated

KOD CODE	L mm	L inch	g	TL/Ad.
6210 27 0250	250	10"	555	5 120,40
6210 27 0275	275	11"	600	5 131,70
6210 27 0300	300	12"	640	5 157,90

6820**Tenekeci Makası**
Tinman's Snip

TSEK



Özel alaşımlı çelik, Kesici ağızlar indüksiyonda sertleştirilmiş, PVC izoleli
Special steel, Cutters induction hardened, PVC insulated

KOD CODE	L mm	L inch	g	TL/Ad.
6820 27 0200	200	8"	320	5 92,15
6820 27 0250	250	10"	575	5 107,00
6820 27 0300	300	12"	870	5 128,35

6211**Kaportacı Makası (Sol)**
Punch Snip (Left)

DIN 6438



Özel alaşımlı çelik, Kesici ağızlar indüksiyonda sertleştirilmiş, PVC izoleli
Special steel, Cutters induction hardened, PVC insulated

KOD CODE	L mm	L inch	g	TL/Ad.
6211 27 0250	250	10"	535	5 120,40
6211 27 0275	275	11"	605	5 131,70
6211 27 0300	300	12"	665	5 157,90

6821**Tenekeci Makası (Yaylı)**
Tinman's Snip (With Spring)

TSEK



Özel alaşımlı çelik, Kesici ağızlar indüksiyonda sertleştirilmiş, PVC izoleli
Special steel, Cutters induction hardened, PVC insulated

KOD CODE	L mm	L inch	g	TL/Ad.
6821 27 0250	250	10"	575	5 116,25
6821 27 0300	300	12"	895	5 139,95

6800

Kuyumcu Makası (Düz)
Jeweller's Snip (Straight)

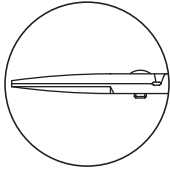

KOD CODE	L mm	L inch	g	TL/Ad.
6800 27 0180	180	7 1/8"	140	5 106,60

6815

Tel Kesme Makası
Bolt Cutters



KOD CODE	L mm	L inch	g	TL/Ad.
6815 27 0200	200	8"	295	5 47,50

6801

Kuyumcu Makası (Eğri)
Jeweller's Snip (Curved)

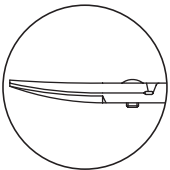

KOD CODE	L mm	L inch	g	TL/Ad.
6801 27 0180	180	7 1/8"	140	5 116,60

6740

Kombine Makas
Multi Purpose Scissors



KOD CODE	L mm	L inch	g	TL/Ad.
6740 27 0140	140	5 1/2"	60	5 99,20
6740 27 0190	190	7 1/2"	120	5 112,40

9

6710

Bağ Makası (Lüks)
Pruning Shears (Lux)



Özel alaşımlı çelik, Kesici ağızlar indüksiyonda sertleştirilmiş, PVC izoleli
Special steel, Cutters induction hardened, PVC insulated

KOD CODE	L mm	L inch	g	TL/Ad.
6710 27 0230	230	9"	390	5 97,20

6715

Bağ Makası (Comfort)
Pruning Shears (Comfort)



Özel alaşımlı çelik, PVC izoleli
Special steel, PVC insulated

KOD CODE	L mm	L inch	g	TL/Ad.
6715 27 0225	225	9"	340	5 148,10

6720

Bağ Makası (Hafif Tip)
Pruning Shears (Light)



Alüminyum gövde, PVC izoleli
Aluminum forged body, PVC insulated

KOD CODE	L mm	L inch	g	TL/Ad.
6720 27 0220	220	8 5/8"	265	5 171,75

6712

Elma Makası
Pruning Shears (Fruit)



Özel alaşımlı çelik, Kesici ağızlar indüksiyonda sertleştirilmiş, PVC izoleli
Special steel, Cutters induction hardened, PVC insulated

KOD CODE	L mm	L inch	g	TL/Ad.
6712 27 0210	210	8 1/4"	365	5 157,05

6760

Narenciye Makası
Pruning Shears (Citrus)



Özel alaşımlı çelik, Kesici ağızlar indüksiyonda sertleştirilmiş, PVC izoleli
Special steel, Cutters induction hardened, PVC insulated

KOD CODE	L mm	L inch	g	TL/Ad.
*6760 27 0125	125	5"	125	5 81,20

06760

Plastik Boru Kesme Makası
Plastic Pipe Cutter



 Yedek parça sayfa 198
Spare parts page 198

KOD CODE	Ø mm	g		TL/Ad.
06760 50 042	42	400	5	319,10
06760 50 063	63	610	5	560,00

6860

Teleskopik Boru Kesici (Bakır ve Alüminyum İçin)
Telescopic Tube Cutter (For Copper and Aluminum)



 Yedek parça sayfa 198
Spare parts page 198

KOD CODE	ÖLÇÜ SIZE	g		TL/Ad.
6860 28 0635	1/4" - 1 3/8"	470	1	176,70

6850

Mini Boru Kesici (Bakır ve Alüminyum İçin)
Mini Tube Cutter (For Copper and Aluminum)



 Yedek parça sayfa 198
Spare parts page 198

KOD CODE	ÖLÇÜ SIZE	g		TL/Ad.
6850 28 0322	1/8" - 5/8"	120	1	64,80

6865

Profesyonel Boru Kesici (Çelik İçin)
Professional Tube Cutter (For Steel)



 Yedek parça sayfa 198
Spare parts page 198

KOD CODE	ÖLÇÜ SIZE	g		TL/Ad.
6865 28 1050	1/8" - 2"	2380	1	446,10

6855

Standart Boru Kesici (Bakır ve Alüminyum İçin)
Standard Tube Cutter (For Copper and Aluminum)



 Yedek parça sayfa 198
Spare parts page 198

KOD CODE	ÖLÇÜ SIZE	g		TL/Ad.
6855 28 0330	1/8" - 1 1/8"	305	1	83,05

9



RIZELTAS

MOD. 3710 TM

IZELTAS®

ÇEKTİRMELER

PULLERS

Çektirmeler
Pullers

İç Rulman Çektirmeler
Inside Pullers

Rotil Çektirmeler
Balljoint Pullers

Saplama Sökmeler
Stud Inserters and Removers

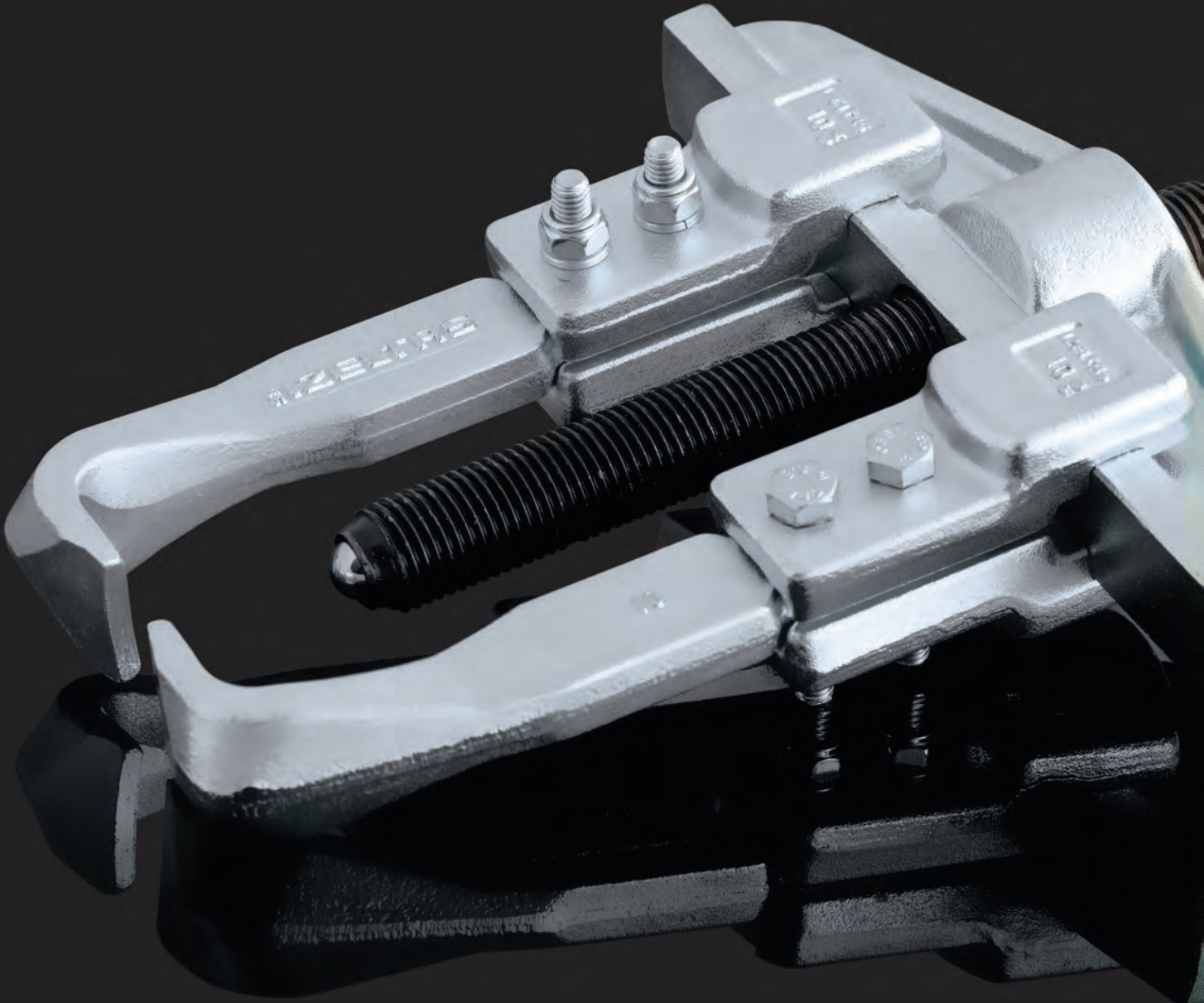

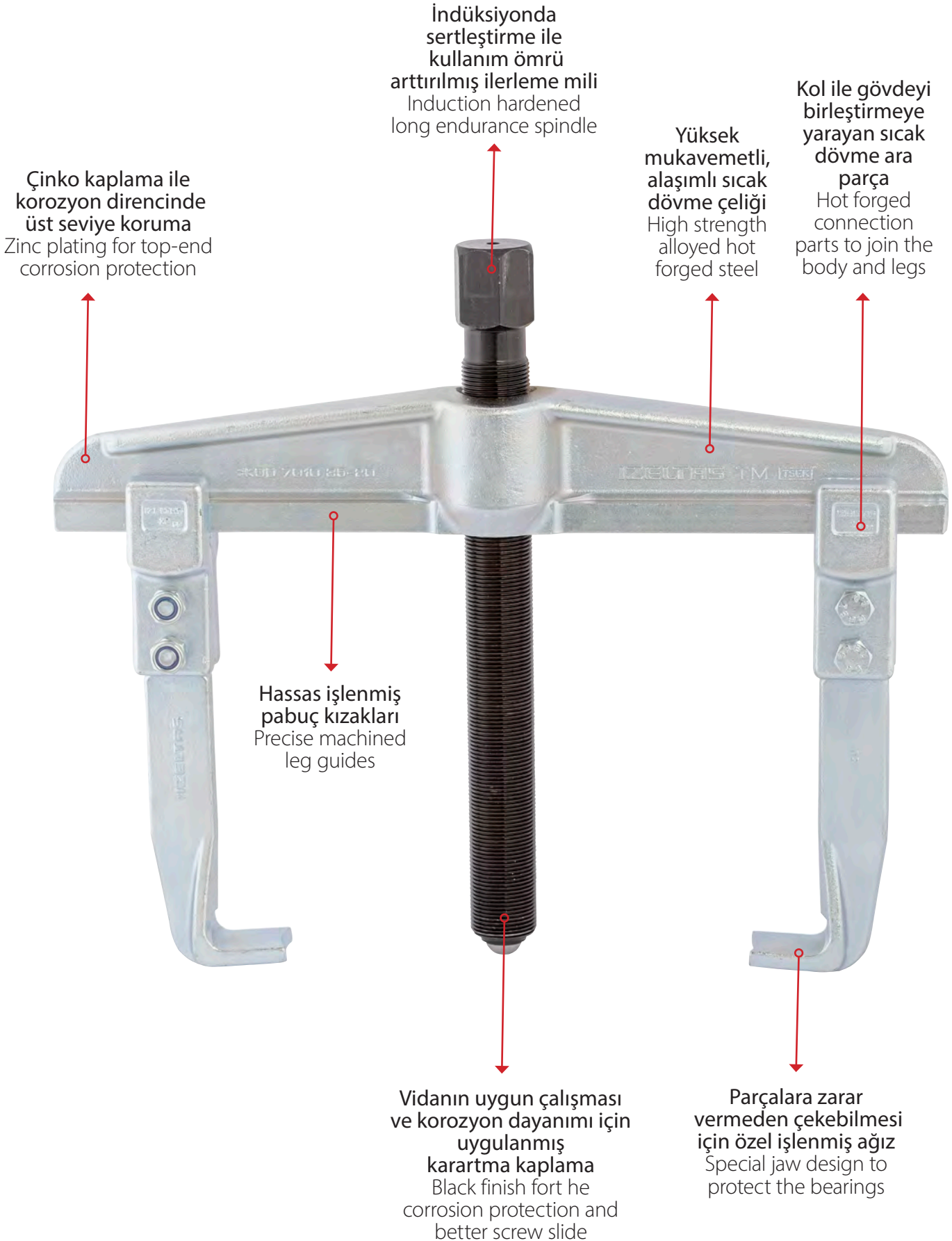

7010

Standart Çektirme (İki Kollu) Standard Puller (Two Arms)

TSEK

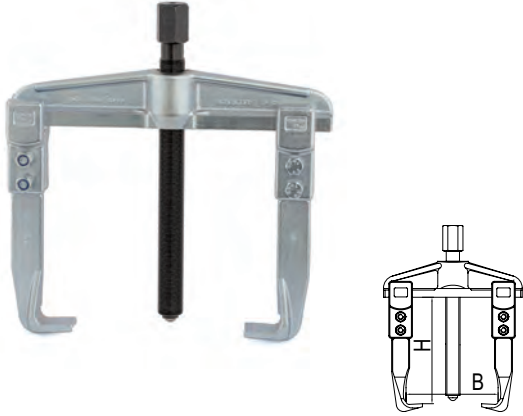

Yedek parça sayfa 199
Spare parts page 199

Krom vanadyum, Çinko kaplı, Kollar sertleştirilmiş,
Mil indüksiyonda sertleştirilmiş
Chrom vanadium, Zinc plated,
Arms hardened, Spindle induction hardened

KOD CODE		B mm	H mm	 g		TL/Ad.
7010 29 0810	8x10	80	100	1080	1	269,00
7010 29 1210	12x10	120	100	1235	1	287,65
7010 29 1615	16x15	160	150	2850	1	490,40
7010 29 2015	20x15	200	150	3060	1	536,40
7010 29 2520	25x20	250	200	4400	1	926,55
7010 29 3520	35x20	350	200	9900	1	1125,30
7010 29 5220	52x20	520	200	13500	1	1654,25

7020

Standart Çektirme (Üç Kollu) Standart Puller (Three Arms)

TSEK

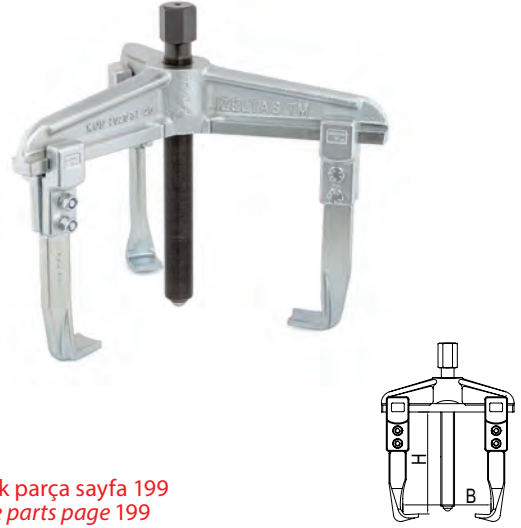

Yedek parça sayfa 199
Spare parts page 199

Krom vanadyum, Çinko kaplı, Kollar sertleştirilmiş,
Mil indüksiyonda sertleştirilmiş
Chrom vanadium, Zinc plated,
Arms hardened, Spindle induction hardened

KOD CODE		B mm	H mm	 g		TL/Ad.
7020 29 3720	37x20	370	200	13700	1	2076,70
7020 29 5220	52x20	520	200	17815	1	2862,85

7010

Çektirme Sehpası Display Frame For Pullers



KOD CODE	İÇERİK CONTENTS	 g		TL/Ad.
7010 00 6105	8x10 - 12x10 - 16x15 20x15 - 25x20	17840	5	2610,00

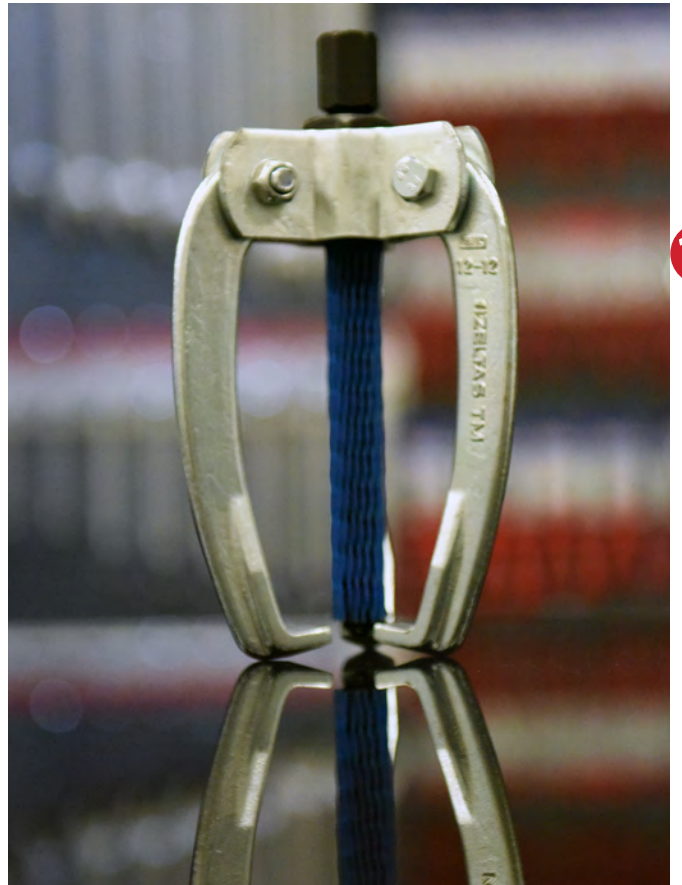

10

7030

Master Çektirme (İki Kollu)
Master Puller (Two Arms)

TSEK

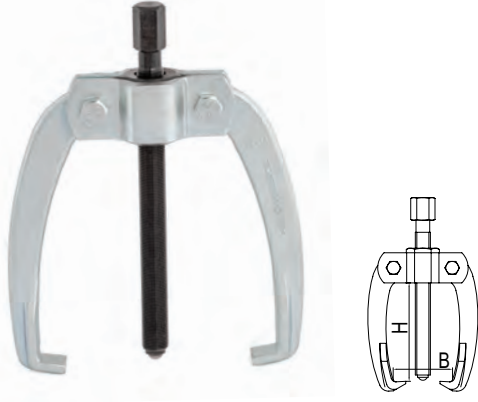

Yedek parça sayfa 199
Spare parts page 199

Krom vanadyum, Çinko kaplı, Kollar sertleştirilmiş,
Mil indüksiyonda sertleştirilmiş
Chrom vanadium, Zinc plated,
Arms hardened, Spindle induction hardened

KOD CODE		B mm	H mm	g	TL/Ad.
7030 29 0808	8x8	80	80	545	1 108,25
7030 29 1212	12x12	120	120	1075	1 223,35
7030 29 1616	16x16	160	160	1885	1 336,15
7030 29 2320	23x20	230	200	3240	1 457,10

7050

Batarya Çektirme (İki Kollu)
Battery Puller (Two Arms)

TSEK

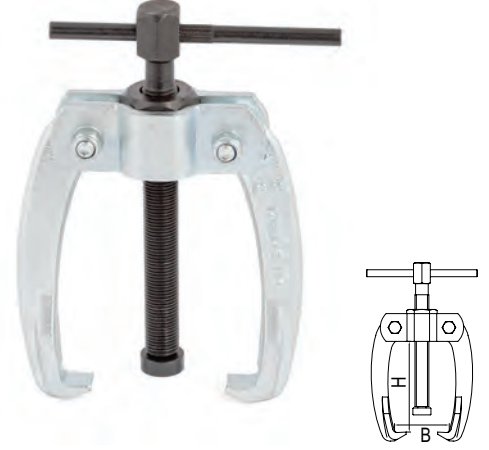

Yedek parça sayfa 199
Spare parts page 199

Krom vanadyum, Çinko kaplı, Kollar sertleştirilmiş,
Mil indüksiyonda sertleştirilmiş
Chrom vanadium, Zinc plated,
Arms hardened, Spindle induction hardened

KOD CODE		B mm	H mm	g	TL/Ad.
7050 29 0604	6x4	60	40	245	1 120,50
7050 29 0606	6x6	60	60	275	1 124,25
7050 29 0808	8x8	80	80	555	1 130,50

7040

Master Çektirme (Üç Kollu)
Master Puller (Three Arms)

TSEK



Yedek parça sayfa 199
Spare parts page 199

Krom vanadyum, Çinko kaplı, Kollar sertleştirilmiş,
Mil indüksiyonda sertleştirilmiş
Chrom vanadium, Zinc plated,
Arms hardened, Spindle induction hardened

KOD CODE		B mm	H mm	g	TL/Ad.
7040 29 0808	8x8	80	80	680	1 207,50
7040 29 1212	12x12	120	120	1355	1 303,70
7040 29 1616	16x16	160	160	2320	1 446,65
7040 29 2320	23x20	230	200	4025	1 601,40

7060

Batarya Çektirme (Üç Kollu)
Battery Puller (Three Arms)

TSEK



Yedek parça sayfa 199
Spare parts page 199

Krom vanadyum, Çinko kaplı, Kollar sertleştirilmiş,
Mil indüksiyonda sertleştirilmiş
Chrom vanadium, Zinc plated,
Arms hardened, Spindle induction hardened

KOD CODE		B mm	H mm	g	TL/Ad.
7060 29 0604	6x4	60	40	300	1 156,45
7060 29 0606	6x6	60	60	345	1 197,25
7060 29 0808	8x8	80	80	715	1 228,85

10

7070

S Tipi Çektirme (İki Kollu)
S Type Puller (Two Arms)

TSEK

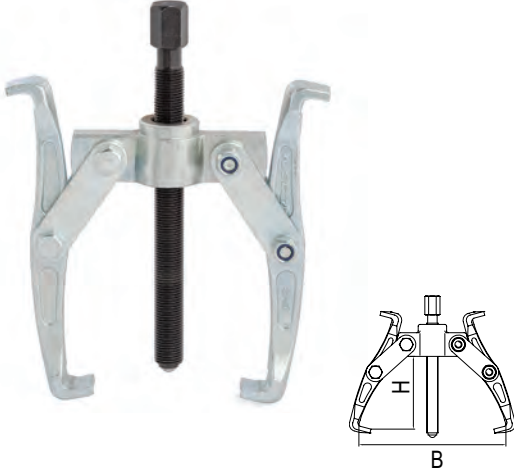

Yedek parça sayfa 199
Spare parts page 199

Krom vanadyum, Çinko kaplı, Kollar sertleştirilmiş,
Mil indüksiyonda sertleştirilmiş
Chrom vanadium, Zinc plated,
Arms hardened, Spindle induction hardened

KOD CODE		B mm	H mm	 g		TL/Ad.
7070 29 2013	20x13	200	130	2420	1	296,90

7090

Üniversal Çektirme (İki Kollu)
Universal Puller (Two Arms)

TSEK

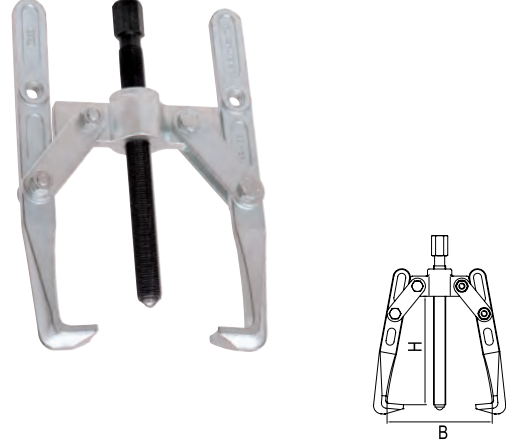

Yedek parça sayfa 199
Spare parts page 199

Krom vanadyum, Çinko kaplı, Kollar sertleştirilmiş,
Mil indüksiyonda sertleştirilmiş
Chrom vanadium, Zinc plated,
Arms hardened, Spindle induction hardened

KOD CODE		B mm	H mm	 g		TL/Ad.
7090 29 2222	22x22	220	220	3085	1	329,90

7080

S Tipi Çektirme (Üç Kollu)
S Type Puller (Three Arms)

TSEK

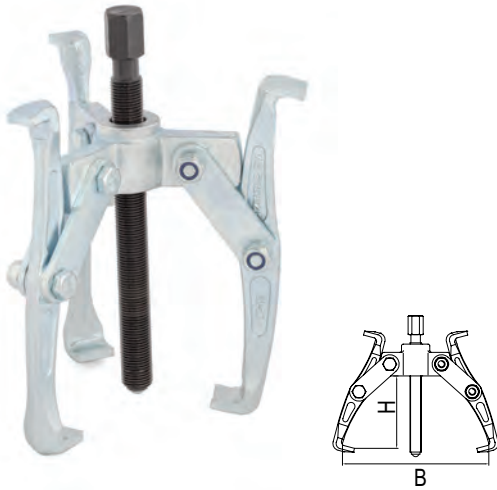

Yedek parça sayfa 199
Spare parts page 199

Krom vanadyum, Çinko kaplı, Kollar sertleştirilmiş,
Mil indüksiyonda sertleştirilmiş
Chrom vanadium, Zinc plated,
Arms hardened, Spindle induction hardened

KOD CODE		B mm	H mm	 g		TL/Ad.
7080 29 2013	20x13	200	130	3250	1	382,90

7100

Üniversal Çektirme (Üç Kollu)
Universal Puller (Three Arms)

TSEK



Yedek parça sayfa 199
Spare parts page 199

Krom vanadyum, Çinko kaplı, Kollar sertleştirilmiş,
Mil indüksiyonda sertleştirilmiş
Chrom vanadium, Zinc plated,
Arms hardened, Spindle induction hardened

KOD CODE		B mm	H mm	 g		TL/Ad.
7100 29 2222	22x22	220	220	4125	1	432,45

10

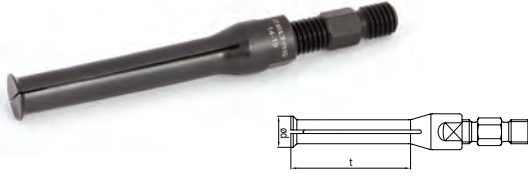
7120
İç Rulman Çektirme Pensleri - Model A
Internal Expansion Puller - Model A

KOD CODE	øD mm	Kullanılan Kol / For	t mm	Adaptör vidası	g	TL/Ad.
7120 29 0507	5 - 7	35 - 75	30	M10	40	1 236,05
7120 29 0709	7 - 9	35 - 75	30	M10	40	1 236,05
7120 29 0912	9 - 12	35 - 75	30	M10	40	1 218,75
7120 29 1013	10 - 13	35 - 75	30	M10	40	1 218,75
7120 29 1317	13 - 17	35 - 75	50	M10	60	1 218,75
7120 29 1419	14 - 19	35 - 75	60	M10	75	1 224,05
7120 29 1621	16 - 21	35 - 75	60	M10	75	1 224,05
7120 29 1823	18 - 23	35 - 75	60	M10	100	1 268,25
7120 29 2025	20 - 25	35 - 75	60	M10	100	1 283,20
7120 29 2530	25 - 30	35 - 75	60	M10	110	1 295,00
7120 29 3037	30 - 37	35 - 75 60 - 130	70	M10	250	1 341,80
7120 29 3542	35 - 42	35 - 75 60 - 130	70	M10	250	1 359,20
7120 29 3845	38 - 45	35 - 75 60 - 130	70	M10	250	1 378,65
7120 29 4350	43 - 50	35 - 75 60 - 130	70	M10	400	1 430,55
★7120 29 4555	45 - 55	60 - 210	100	G3/8	600	1 502,40
★7120 29 5060	50 - 60	60 - 210	100	G3/8	700	1 543,65

7120
İç Rulman Çektirme Pensleri - Model B
Internal Expansion Puller - Model B

KOD CODE	øD mm	Kullanılan Kol / For	t mm	Adaptör vidası	g	TL/Ad.
7120 29 2540	25 - 40	35 - 75 60 - 130	45	M10	235	1 478,10

7120
İç Rulman Çektirme Kolları
Arms For Internal Expansion Puller

Krom vanadyum, Çinko kaplı, Kollar sertleştirilmiş,
Mil indüksiyonda sertleştirilmiş
Chrom vanadium, Zinc plated,
Arms hardened, Spindle induction hardened

KOD CODE	Kapasite Capacity mm	Kullanılan pensler / For	Adaptör vidası Screw Adapter	g	TL/Ad.
----------	----------------------	--------------------------	------------------------------	---	--------

7120 29 3575	35 - 75	Model A 5 - 7'den 43 - 50'ye Model B 25 - 40	M10	625	1 240,50
--------------	---------	--	-----	-----	----------

7120 29 6013	60 - 130	Model A 30 - 37'den 43 - 50'ye Model B 25 - 40	M10	1000	1 487,40
--------------	----------	--	-----	------	----------

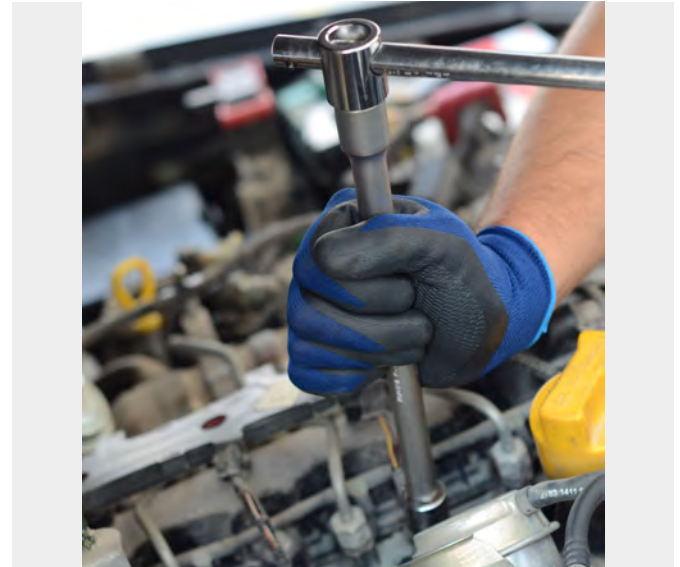

7122

Dış Rulman Çektirme Çeneleri Seperator



Krom vanadyum, Çinko kaplı, Kollar sertleştirilmiş,
Mil indüksiyonda sertleştirilmiş
Chrom vanadium, Zinc plated,
Arms hardened, Spindle induction hardened

KOD CODE	Ø mm	Kullanılan Kollar / For	Adaptör vidası	g	TL/Ad.
7122 29 0560	5 - 60	40 - 115	M12	370	1 365,05
7122 29 1275	12 - 75	40 - 115	M12	635	1 437,50
7122 29 2211	22 - 115	55 - 205	M16x1.5	1780	1 683,20
7122 29 2515	25 - 155	90 - 260	M20x1.5	3940	1 1069,50
7122 29 3022	30 - 220	100 - 360	M20x1.5	11000	1 2923,00
7122 29 4028	40 - 280	140 - 435	M24x1.5	15000	1 6528,60

7125

Rotil Çektirme (Çatal) Ball Joint Separator

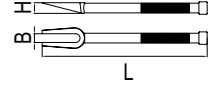

KOD CODE	B mm	H mm	L mm	g	TL/Ad.
★7125 29 0045	45	26	350	1155	1 487,90

7122

Dış Rulman Çektirme Kolları Puller Arms For Separator

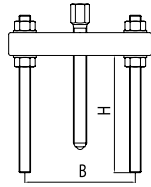

Krom vanadyum, Çinko kaplı, Kollar sertleştirilmiş,
Mil indüksiyonda sertleştirilmiş
Chrom vanadium, Zinc plated,
Arms hardened, Spindle induction hardened

KOD CODE	B mm	Kullanılan Çene / For	H mm	Adaptör vidası	g	TL/Ad.
7122 29 4011	40-115	5 - 60 12 - 75	150	M12	990	1 650,90
7122 29 5520	55-205	22 - 115	210	M16x1.5	2700	1 1030,40
7122 29 9026	90-260	25 - 155	315	M20x1.5	4965	1 1458,80
7122 29 1036	100-360	30 - 220	305	M20x1.5	7000	1 3002,30
7122 29 1443	140-435	40 - 280	320	M24x1.5	11000	1 5868,15

7126

Rotil Çektirme Extractor For Ball Joint

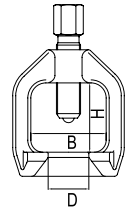

KOD CODE	ØD mm	B mm	H mm	g	TL/Ad.
7126 29 0018	18	40	40	315	1 201,90
7126 29 0025	25	50	50	540	1 276,80
7126 29 0029	29	60	60	915	1 368,25
7126 29 0040	40	80	80	1965	1 519,90
7126 29 0045	45	90	100	2670	1 656,35

10



IZELTAS®

ELTA

ELTA

Anahtarlar
Wrenches

Tornavida ve Allen Anahtarlar
Screwdrivers and Hex Key Wrenches

Lokma Anahtarları
Sockets Wrenches

Keskiler
Chisels

Boru Anahtarları ve Penseler
Pipe Wrenches and Pliers

Makaslar
Shears



DIY Elta Tools

0150

İki Ağız Anahtar (mm)

Double Ended Open Jaw Wrench (mm)



TS 81-6 • DIN 895

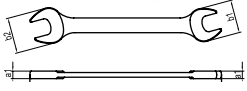

Krom vanadyum, Krom kaplı
Chrom vanadium, Chrom plated

KOD CODE	mm	L mm	a1 mm	b1 mm	b2 mm	g	TL/Ad.
0150 01 0607	6x7	98	3.3	13.5	15.5	10	8,35
0150 01 0809	8x9	108	3.6	17.5	19.5	20	8,50
0150 01 1011	10x11	120	4	21.5	23.5	30	9,20
0150 01 1213	12x13	134	4.5	25.6	27.6	40	10,15
0150 01 1415	14x15	150	5	29.6	31.5	60	11,80
0150 01 1617	16x17	163	5.5	33.5	35.5	85	13,70
0150 01 1819	18x19	178	6	37.4	39.4	110	14,70
0150 01 2022	20x22	198	6.5	41.4	45.5	145	16,70
0150 01 2123	21x23	218	6.9	43.5	47.5	175	18,20
0150 01 2426	24x26	236	7.4	49.4	53.5	235	19,50
0150 01 2528	25x28	250	7.8	51.5	57.5	275	24,25
0150 01 2732	27x32	265	8.3	55.5	65.6	345	28,95

0150

İki Ağız Anahtar Takımı (mm)

Double Ended Open Jaw Wrench Set (mm)



KOD CODE	İÇERİK CONTENTS	g	TL/Ad.
0150 00 2108	6x7 - 8x9 - 10x11 12x13 - 14x15 - 16x17 18x19 - 20x22	560	8 93,10
0150 00 2112	6x7 - 8x9 - 10x11 12x13 - 14x15 - 16x17 18x19 - 20x22 - 21x23 24x26 - 25x28 - 27x32	1590	12 184,00

11

0350

Kombine Anahtar (mm) Combination Wrench (mm)



TS 3794
TS ISO 7738 Form A
DIN 3113

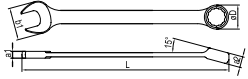

Krom vanadyum, Krom kaplı
Chrom vanadium, Chrom plated

KOD CODE	mm	L mm	a1 mm	a2 mm	b1 mm	øD mm	g	TL/ Ad.
0350 02 0006	6	95	3.1	5.1	13.5	15.1	15	10,90
0350 02 0007	7	104	3.3	5.5	15.5	11.5	15	11,55
0350 02 0008	8	112	3.7	5.9	17.5	12.8	20	12,55
0350 02 0009	9	121	3.9	6.3	19.5	14.1	25	12,95
0350 02 0010	10	130	4.3	6.9	21.5	15.3	30	14,60
0350 02 0011	11	138	4.5	7.3	23.4	16.3	35	15,05
0350 02 0012	12	146	4.9	7.7	25.6	17.8	45	16,05
0350 02 0013	13	154	5.1	8.1	27.6	19	50	16,35
0350 02 0014	14	163	5.5	8.7	29.6	20.4	60	17,60
0350 02 0015	15	171	5.7	9.1	31.5	21.9	70	18,90
0350 02 0016	16	180	6.1	9.5	33.5	23.2	85	20,25
0350 02 0017	17	189	6.3	9.9	35.5	24.8	95	21,70
0350 02 0018	18	200	6.7	10.4	37.4	26.5	110	24,10
0350 02 0019	19	211	6.9	11	39.4	27.9	130	25,40
0350 02 0020	20	222	7.3	11.4	41.4	29.3	145	25,80
0350 02 0021	21	235	7.3	11.4	43.5	31	160	30,05
0350 02 0022	22	250	8.1	12.6	45.5	32.5	200	34,35
0350 02 0024	24	270	8.7	13.6	49.4	35.7	250	42,00
0350 02 0027	27	300	9.6	14.8	55.5	40.1	350	49,45
0350 02 0030	30	330	10.2	15.8	61.7	44.7	445	56,80
0350 02 0032	32	350	10.4	16.2	65.6	46.8	500	59,55

0350

Kombine Anahtar Takımı (mm) Combination Wrench Set (mm)

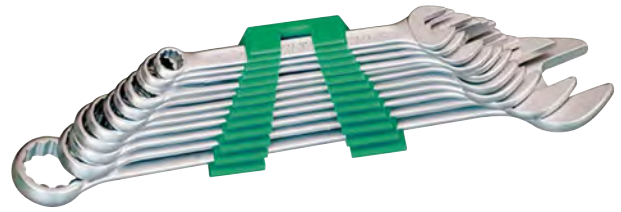

KOD CODE	İÇERİK CONTENTS	g	TL/Ad.
0350 00 2108	6 - 7 - 8 - 9 - 10 - 13 17 - 19	395	8 126,00
0350 00 2112	8 - 9 - 10 - 11 - 12 13 - 14 - 15 - 16 17 - 19 - 22	855	12 225,75
0350 00 2117	6 - 7 - 8 - 9 - 10 11 - 12 - 13 - 14 15 - 16 - 17 - 18 19 - 20 - 21 - 22	1300	17 328,15
0350 00 2121	6 - 7 - 8 - 9 - 10 11 - 12 - 13 - 14 15 - 16 - 17 - 18 19 - 20 - 21 - 22 24 - 27 - 30 - 32	2810	21 535,95

11

Yıldız İki Ağız Anahtar (mm) Double Ended Ring Wrench (mm)



TS 3794
TS ISO 10104 Form B
DIN 838

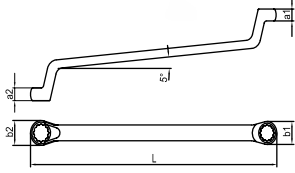

Krom vanadyum, Krom kaplı
Chrom vanadium, Chrom plated

KOD CODE	mm	L mm	a1 mm	a2 mm	b1 mm	b2 mm	g	TL/Ad.
0450 03 0607	6x7	176	5.5	6	10.5	11.7	45	10 18,85
0450 03 0809	8x9	190	6.5	7	13.8	15.1	60	10 19,10
0450 03 1011	10x11	206	7.5	8	16.1	17.3	90	10 21,20
0450 03 1213	12x13	220	8.5	9	19	20.5	100	10 23,95
0450 03 1415	14x15	236	9.5	10	22.2	23.8	140	10 25,15
0450 03 1617	16x17	250	10.7	11.2	25.2	26.7	190	10 28,50
0450 03 1819	18x19	271	11.7	12	28	29.5	240	10 34,05
0450 03 2022	20x22	291	12.5	13.2	31	34	255	5 37,25
0450 03 2123	21x23	310	12.8	13.4	32.7	35.6	300	5 42,75
0450 03 2426	24x26	331	13.6	14.3	37	40	335	5 49,75
0450 03 2528	25x28	350	13.8	15	38.6	43.1	430	5 54,55
0450 03 2732	27x32	371	14.8	16.4	41.5	48.5	525	5 60,05

0450

Yıldız İki Ağız Anahtar Takımı (mm) Double Ended Ring Wrench Set (mm)

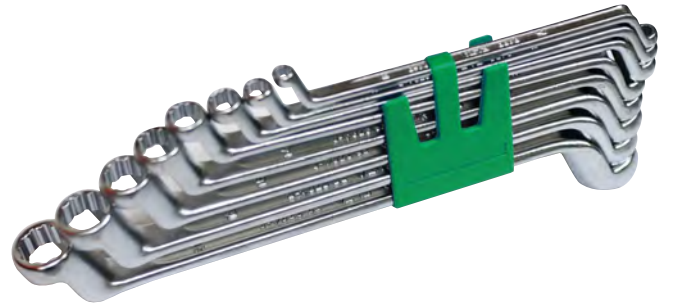

KOD CODE	İÇERİK CONTENTS	g	TL/Ad.
0450 00 2108	6x7 - 8x9 - 10x11 12x13 - 14x15 - 16x17 18x19 - 20x22	1120	8 208,05
0450 00 2112	6x7 - 8x9 - 10x11 12x13 - 14x15 - 16x17 18x19 - 20x22 - 21x23 24x26 - 25x28 - 27x32	2710	12 415,15

(★) İşaretli olan ürünler stoklarla sınırlıdır.
Limited with stocks.

0701

Çatal Çakma Anahtar (mm)
Slugging Open Jaw Wrench (mm)

TS 81
DIN 133



Krom vanadyum
Chrom vanadium

KOD CODE	mm	L mm	a1 mm	b mm	g	TL/Ad.
★0701 05 0024	24	160	15	42	280	1 41,05
★0701 05 0042	42	230	19	62	930	1 119,35
★0701 05 0095	95	445	38	140	8160	1 862,05

0751

Yıldız Çakma Anahtar (mm)
Slugging Ring Wrench (mm)

TS 3794
DIN 7444



Krom vanadyum
Chrom vanadium

KOD CODE	mm	L mm	a1 mm	b mm	g	TL/Ad.
★0751 05 0042	42	225	20	64	730	1 124,00
★0751 05 0070	70	330	32	109	2890	1 349,90
★0751 05 0085	85	360	35	123	3635	1 598,50

0601

Kurbağacak Anahtar
Adjustable Wrench

TS 3796
DIN 3117



Krom vanadyum, Krom kaplı, PVC izoleli
Chrom vanadium, Chrom plated, PVC Insulated

KOD CODE	L mm	L inch	a mm	g	TL/Ad.
0601 01 0008	206	8"	23	240	5 66,50
0601 01 0010	256	10"	28	400	5 100,10
0601 01 0012	306	12"	34	650	5 127,75

1801

Kovan Anahtar İki Ağız (mm)
Double Ended Tubular Socket Wrench (mm)

TS ISO 3793
DIN 896

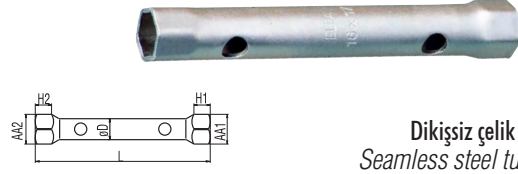

Dikişsiz çelik boru, Çinko kaplı
Seamless steel tube, Zinc plated

KOD CODE	mm	L mm	AA1 mm	AA2 mm	H1 mm	H2 mm	σ D mm	g	TL/Ad.
★1801 07 0607	6x7	105	8.6	9.6	7	8	8	25	5 16,10
★1801 07 2022	20x22	165	25.4	27.4	16	18	22	220	5 34,50
★1801 07 2123	21x23	165	26.4	28.4	17	19	24	240	5 38,60
★1801 07 2426	24x26	180	30.4	32.4	20	22	26	340	5 50,05
★1801 07 2528	25x28	200	31.4	34.4	21	24	28	400	5 58,90
★1801 07 2732	27x32	200	33.4	38.4	23	26	30	435	5 68,55

1875

Ağır Tip Bijon Anahtarı İki Ağız Uzun
Double Ended Rim Wrench (long)

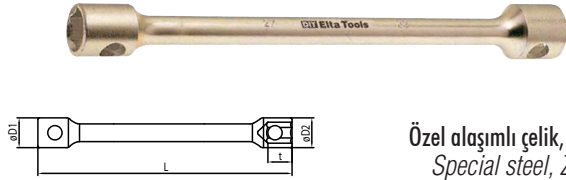

Özel alaşımli çelik, Çinko kaplı
Special steel, Zinc plated

KOD CODE	mm	L mm	t mm	σD1 mm	σD2 mm	g	g	TL/Ad.
★1875 09 2224	22x24	400	34.5	34	36	1060	2310	10 81,20

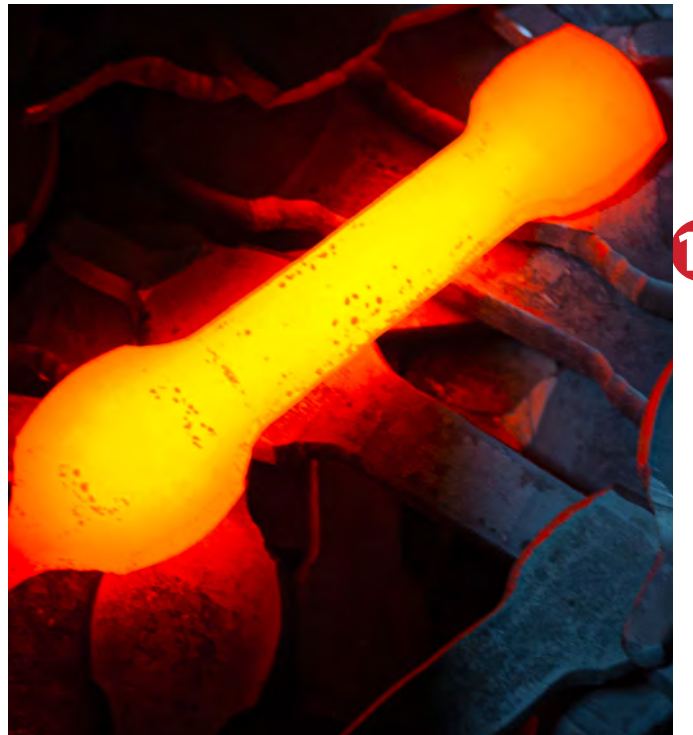

11

DIY Elta Tools

1115

1/2" Altı Köşe Lokma Anahtar (mm)
Socket Wrench 6 Points (mm)

TS ISO 2725
DIN 3124



1/2"

Krom vanadyum, Krom kaplı
Chrom vanadium, Chrom plated

KOD CODE	mm	Ø D1 mm	Ø D2 mm	L mm	L1 mm	g	TL/Ad.	
1115 06 0010	10	15	23.3	38	8	60	10	12,45
1115 06 0011	11	16.4	23.3	38	8	60	10	12,45
1115 06 0012	12	17.8	23.3	38	9	60	10	12,45
1115 06 0013	13	19	23.3	38	10	60	10	12,90
1115 06 0014	14	20.4	23.3	38	11	60	10	12,90
1115 06 0015	15	21.6	23.3	38	11	65	10	12,90
1115 06 0016	16	22.9	24	38	11	70	10	13,45
1115 06 0017	17	24	22.5	38	12	70	10	13,45
1115 06 0018	18	25.2	23	38	13	75	10	13,45
1115 06 0019	19	26.8	23	38	13	75	10	14,45
1115 06 0020	20	28	23	38	13	80	10	14,45
1115 06 0021	21	29.2	23	38	13	80	5	14,45
1115 06 0022	22	30.2	24	40	15	95	5	14,45
1115 06 0023	23	31.4	25	40	15	100	5	15,70
1115 06 0024	24	32.6	26	42	17	115	5	15,70
1115 06 0026	26	35.3	28	42	17	130	5	17,65
1115 06 0027	27	36.6	28	42	19	140	5	20,10
1115 06 0028	28	37.8	30	42	20	160	5	21,20
1115 06 0030	30	40	29.5	44	21	175	5	21,20
1115 06 0032	32	42.5	30	44	23	180	5	22,65

1514

1/2" T Kol
Sliding T - Handle

TS ISO 3315
DIN 3122



1/2"

Krom vanadyum, Krom kaplı
Chrom vanadium, Chrom plated

KOD CODE	L mm	g	TL/Ad.	
1514 06 4025	250	370	5	49,25

1514

1/2" T Kol Adaptörü
Adapter



1/2"

Krom vanadyum, Krom kaplı
Chrom vanadium, Chrom plated

KOD CODE	inch	g	TL/Ad.	
1514 06 6250	3/8"Fx1/2"M	90	5	31,00

1514

1/2" Ara Kol
Extension Bar

TS ISO 1174
DIN 3123



1/2"

Krom vanadyum, Krom kaplı
Chrom vanadium, Chrom plated

KOD CODE	L mm	g	TL/Ad.	
1514 06 4125	125	220	5	28,35
1514 06 4250	250	425	5	49,25

1514

1/2" Mafsal
Universal Joint

TS ISO 1174
DIN 3123



1/2"

Krom vanadyum, Krom kaplı
Chrom vanadium, Chrom plated

KOD CODE	L mm	g	TL/Ad.	
1514 06 4065	65	140	5	33,80

Havali aletler ile kullanmayınız / Do not use with power-tools

1514

1/2" U Kol
Speed brace with revolving rubber handle

TS ISO 3315
DIN 3122



1/2"

Krom vanadyum, Krom kaplı
Chrom vanadium, Chrom plated

KOD CODE	L mm	g	TL/Ad.
★1514 06 4420	420	510	5 78,70

1514

1/2" Cırcır Kolu
Ratchet Handle

TS ISO 3315
DIN 3122



1/2"

Krom vanadyum, Krom kaplı
Chrom vanadium, Chrom plated

KOD CODE	L mm	g	TL/Ad.
1514 06 5250	250	585	5 115,50

1115

1/2" Altı Köşe Lokma Anahtar Takımı (17 Parça, mm)
Socket Wrench Set 6 Points (17 pcs, mm)



1/2"

KOD CODE	LOKMALAR Sockets	AVADANLIKLAR Accessories	g	TL/Ad.
1115 00 2017	10 - 11 - 12 13 - 14 - 15 17 - 19 - 22 24 - 27 - 30 32	1/2" Cırcır Kolu Ratchet Handle 1/2" T Kol Adaptör Sliding T Handle Adapter 1/2" Mafsal Universal Joint 1/2" Ara Kol Extension Bar 250 mm	2650	17 427,60

1115

1/2" Altı Köşe Lokma Anahtar Takımı (18 Parça, mm)
Socket Wrench Set 6 Points (18 pcs, mm)



1/2"

KOD CODE	LOKMALAR Sockets	AVADANLIKLAR Accessories	g	TL/Ad.
★1115 00 6018	10 - 11 - 12 13 - 14 - 15 17 - 19 - 22 24 - 27 - 30 32	1/2" Cırcır Kolu Ratchet Handle 1/2" U Kol Speed Brace with Revolving Rubber Handle 1/2" T Kol Sliding T Handle 1/2" Mafsal Universal Joint 1/2" Ara Kol Extension Bar 250 mm	4775	18 524,55

1115

1/2" Altı Köşe Lokma Anahtar Takımı (24 Parça, mm)
Socket Wrench Set 6 Points (24 pcs, mm)



1/2"

KOD CODE	LOKMALAR Sockets	AVADANLIKLAR Accessories	g	TL/Ad.
1115 00 2024	10 - 11 - 12 13 - 14 - 15 16 - 17 - 18 19 - 21 - 22 23 - 24 - 26 27 - 28 - 30 - 32	1/2" Cırcır Kolu Ratchet Handle 1/2" Mafsal Universal Joint 1/2" T Kol Adaptör Sliding T Handle Adapter 1/2" Ara Kol Extension Bar 125 mm 1/2" Ara Kol Extension Bar 250 mm	3485	24 551,85

Havali aletler ile kullanmayınız / Do not use with power-tools

DIY Elta Tools

1121

3/4" Altı Köşe Lokma Anahtar (mm)
Socket Wrench 6 Points (mm)

TS ISO 2725
DIN 3124

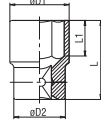

3/4"

Krom vanadyum, Krom kaplı
Chrom vanadium, Chrom plated

KOD CODE	mm	Ø D1 mm	Ø D2 mm	L mm	L1 mm	g	TL/Ad.
★1121 06 0022	22	33	36	52	16	220	5 26,85
★1121 06 0024	24	35	36	52	16	220	5 26,85
★1121 06 0027	27	38	36	52	19	235	5 27,40
★1121 06 0030	30	42	38	54	21	295	5 30,45
★1121 06 0034	34	47	42	58	24	400	5 45,90
★1121 06 0041	41	56	45	64	29	570	5 65,50
★1121 06 0046	46	62	48	68	33	725	1 70,70
★1121 06 0050	50	68	48	72	34	905	1 86,10
★1121 06 0055	55	76	48	76	37	1095	1 102,55
★1121 06 0060	60	80	48	78	38	1275	1 119,10

1521

3/4" Ara Kol
Extension Bar

TS ISO 1174
DIN 3123



3/4"

Krom vanadyum, Krom kaplı
Chrom vanadium, Chrom plated

KOD CODE	L mm	g	TL/Ad.
★1521 06 4200	200	730	5 100,75
★1521 06 4400	400	1380	5 179,00

11 1521

3/4" T Kol
Sliding T - Handle

TS ISO 3315
DIN 3122



3/4"

Krom vanadyum, Krom kaplı
Chrom vanadium, Chrom plated

KOD CODE	L mm	g	TL/Ad.
★1521 06 4500	500	1490	5 192,50

1115

1/2" Altı Köşe Havalı Lokma Anahtar (mm)
Impact Socket Wrench 6 Points (mm)

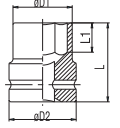

1/2"

Krom molibden, Fosfat kaplamalı
Chrom molybdenum, Phosphate finish

KOD CODE	mm	Ø D1 mm	Ø D2 mm	L mm	g	TL/Ad.
★1115 06 7010	10	17	25	38	70	10 12,00
★1115 06 7011	11	18	25	38	70	10 12,00
★1115 06 7012	12	19	25	38	70	10 12,00
★1115 06 7013	13	20	25	38	70	10 12,00
★1115 06 7014	14	22	25	38	75	10 12,00
★1115 06 7015	15	23	30	38	110	10 13,60
★1115 06 7016	16	24	30	38	110	10 13,60
★1115 06 7017	17	26	30	38	115	10 15,70
★1115 06 7018	18	27	30	38	115	10 15,70
★1115 06 7019	19	28	30	38	120	10 15,70
★1115 06 7021	21	30	30	40	125	5 17,95
★1115 06 7022	22	32	30	40	145	5 17,95
★1115 06 7024	24	34	30	42	150	5 20,95
★1115 06 7027	27	38	30	44	175	5 24,20

1514

1/2" Havalı Lokma Ara Kol
Impact Socket Extension Bar



1/2"

Krom molibden, Fosfat kaplamalı
Chrom molybdenum, Phosphate finish

KOD CODE	L mm	g	TL/Ad.
★1514 06 7125	125	275	5 35,30
★1514 06 7250	250	450	5 48,65

Havalı aletler ile kullanmayınız / Do not use with power-tools

1121

3/4" Altı Köşe Havalı Lokma Anahtar (mm)
Impact Socket Wrench 6 Points (mm)

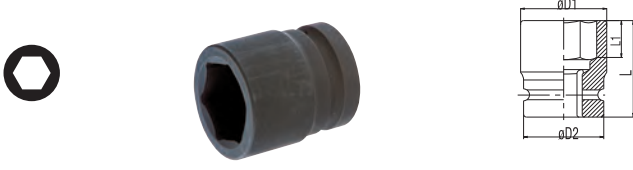

3/4"

Krom molibden, Fosfat kaplamalı
Chrom molybdenum, Phosphate finish

KOD CODE	mm	Ø D1 mm	Ø D2 mm	L mm	L1 mm	g	TL/Ad.
★1121 06 7019	19	32	44	50	12	315	5 36,30
★1121 06 7022	22	36	44	50	15	345	5 36,30
★1121 06 7024	24	38	44	50	16	350	1 36,30
★1121 06 7027	27	42	44	53	17	380	1 37,50
★1121 06 7030	30	46	44	53	20	410	1 39,00
★1121 06 7034	34	51	44	57	22	490	1 40,25
★1121 06 7041	41	59	44	58	24	580	1 69,70
★1121 06 7046	46	66	44	62	24	720	1 69,70

1521

3/4" Havalı Lokma Ara Kol
Impact Socket Extension Bar



3/4"

Krom molibden, Fosfat kaplamalı
Chrom molybdenum, Phosphate finish

KOD CODE	L mm	g	TL/Ad.
★1521 06 7175	175	865	5 69,25
★1521 06 7250	250	1155	5 89,25
★1521 06 7330	330	1425	5 114,45

1521

3/4" Havalı Lokma Mafsalsı
Impact Socket Universal Joint



3/4"

Krom molibden, Fosfat kaplamalı
Chrom molybdenum, Phosphate finish

KOD CODE	L mm	g	TL/Ad.
★1521 06 7108	108	735	1 120,50

2203

Maşalı Boru Anahtarı (85°)
Pipe Wrench (85°)

DIN 5234



Krom vanadyum, Dişler induksiyonda sertleştirilmiş, Elektrostatik boyanmış
Chrom vanadium, Teeth induction hardened, Electrostatically painted

KOD CODE	L mm	mm	inch	g	TL/Ad.
2203 10 0010	310	45	1"	760	1 102,70
2203 10 0015	425	60	1 1/2"	1360	1 157,90
2203 10 0020	560	75	2"	2350	1 235,40
★2203 10 0030	760	105	3"	3200	1 360,80

2401

Fort Pense
Waterpump Pliers

TS 60
DIN 8976

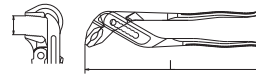

Krom vanadyum, Nikel kaplı, PVC izoleli
Chrom vanadium, Nickel plated, PVC Insulated

KOD CODE	L mm	L inch	mm	g	TL/Ad.
2401 11 0240	240	9 1/2"	35	375	5 89,15

2509

Ayarlı Pense
Grip

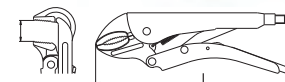

Genel krom vanadyum gelişiminden dövülmüştür, Nikel kaplama,
Kullanım sahası: Yuvarlak ve düz malzemeler
Jaws Chrom vanadium forged, Nickel plated
Application field : Flat and round materials

KOD CODE	L mm	L inch	mm	g	TL/Ad.
2509 11 0225	225	9"	30	470	5 84,60

11

DIY Elta Tools

3021

Kombine Pense Opak
Combination Pliers

TS 60
DIN ISO 5746



Özel alaşımli çelik, Kesici ağızlar indüksiyonda sertleştirilmiş, Krom kaplı, PVC saplı
Special steel, Cutters induction hardened, Chrom plated, PVC handle

KOD CODE	L mm	L inch	MODEL	g	TL/Ad.
3021 12 1160	160	6 1/4"	OPAK	200	5 49,75
3021 12 1180	180	7 1/8"	OPAK	250	5 60,90
3021 12 1200	200	8"	OPAK	310	5 74,25

3303

Dış Segman Pense (Yaylı Düz)
Circlip Pliers, External (Flat)

TS 60



Krom vanadyum, Krom kaplı, PVC izoleli
Chrom vanadium, Chrom plated, PVC Insulated

KOD CODE	L mm	g	TL/Ad.
★3303 12 0140	140	10 - 25 90	5 61,25
★3303 12 0180	180	19 - 60 165	5 64,55
★3303 12 0220	220	40 - 100 315	5 77,20

3221

Kargaburun Düz Uçlu Opak
Long Nose Pliers (Flat)

TS 60
TS ISO 5745



Özel alaşımli çelik, Kesici ağızlar indüksiyonda sertleştirilmiş, Krom kaplı, PVC saplı
Special steel, Cutters induction hardened, Chrom plated, PVC handle

KOD CODE	L mm	L inch	MODEL	g	TL/Ad.
3221 13 1160	160	6 1/4"	OPAK	145	5 54,00
3221 13 1200	200	8"	OPAK	190	5 61,85

3304

Dış Segman Pense (Yaylı Eğri)
Circlip Pliers,
External (Bent)

TS 60



Krom vanadyum, Krom kaplı, PVC izoleli
Chrom vanadium, Chrom plated, PVC Insulated

KOD CODE	L mm	g	TL/Ad.
★3304 12 0125	125	10 - 25 90	5 68,35
★3304 12 0200	200	40 - 100 315	5 85,85

3701

Yan Keski Opak
Side Cutting Pliers

TS 60
TS ISO 5749
DIN 5749



Özel alaşımli çelik, Kesici ağızlar indüksiyonda sertleştirilmiş, Krom kaplı, PVC saplı
Special steel, Cutters induction hardened, Chrom plated, PVC handle

KOD CODE	L mm	L inch	MODEL	g	TL/Ad.
3701 16 1140	140	5 1/2"	OPAK	160	5 45,80
3701 16 1160	160	6 1/4"	OPAK	220	5 53,85

3323

İç Segman Pense (Yaysız Düz)
Circlip Pliers
Internal (Flat)

TS 60

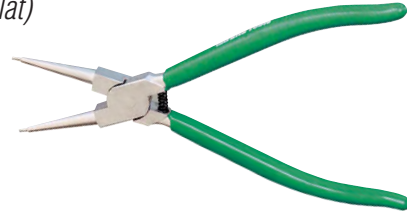

Krom vanadyum, Krom kaplı, PVC izoleli
Chrom vanadium, Chrom plated, PVC Insulated

KOD CODE	L mm	g	TL/Ad.
★3323 12 0140	140	8 - 25 90	5 56,30
★3323 12 0180	180	19 - 60 140	5 59,40
★3323 12 0230	230	40 - 100 300	5 83,75

11

3324

İç Segman Pense (Yaysız Eğri)
Circlip Pliers
Internal (Bent)

TS 60



Krom vanadyum, Krom kaplı, PVC izoleli
Chrom vanadium, Chrom plated, PVC Insulated

KOD CODE	L mm	⌀	g	TL/Ad.
★3324 12 0130	130	8 - 25	90	5 60,50
★3324 12 0170	170	19 - 60	140	5 63,75
★3324 12 0210	210	40 - 100	300	5 76,05

3801

Kerpeten
Carpenter Pincers

TS 60
TS ISO 9243
DIN ISO 9243



Özel alaşımlı çelik, Kesici ağızlar induksiyonda sertleştirilmiş, Vernikli, PVC izoleli
Special steel, Cutters induction hardened, Lacquered, PVC Insulated

KOD CODE	L mm	L inch	g	TL/Ad.
3801 15 0160	160	6 1/4"	235	5 50,50
3801 15 0180	180	7 1/8"	245	5 54,55
3801 15 0200	200	8"	390	5 66,00

3832

Betoncu Kerpeteni
Tower Pincers

TS 60
TS ISO 9242
DIN ISO 9242



Özel alaşımlı çelik, Kesici ağızlar induksiyonda sertleştirilmiş, Vernikli, PVC izoleli
Special steel, Cutters induction hardened, Lacquered, PVC insulated

KOD CODE	L mm	L inch	g	TL/Ad.
3832 15 0225	225	9"	335	5 60,90
3832 15 0250	250	10"	415	5 69,40
3832 15 0280	280	11"	475	5 84,20

4150

Opak Seri Düz Uçlu Tornavida
Screwdriver, Opak, Flat

TS ISO 2380 - 1
DIN ISO 2380-1

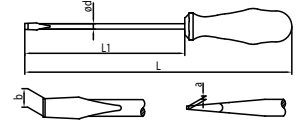

Krom vanadyum, Krom kaplı, PP saplı
Chrom vanadium, Chrom plated, PP handle

KOD CODE	σDxL1 mm	⌀		L mm	g	TL/Ad.
		a mm	b mm			
4150 17 0380	3x80	0.5	3	150	20	10 8,45
4150 17 0480	4x80	0.8	4	170	30	10 9,75
4150 17 4100	4x100	0.8	4	190	40	10 10,45
4150 17 5100	5x100	1.0	5.5	200	55	10 12,60
4150 17 5125	5x125	1.0	5.5	225	60	10 14,55
4150 17 6100	6x100	1.2	6.5	200	70	10 13,05
4150 17 6125	6x125	1.2	6.5	225	75	10 14,90
4150 17 6150	6x150	1.2	6.5	250	80	10 16,40
★4150 17 7125	7x125	1.2	8	260	110	10 16,50
4150 17 7150	7x150	1.2	8	260	110	10 19,25
4150 17 8150	8x150	1.6	10	260	130	10 20,85
4150 17 8175	8x175	1.6	10	285	135	10 23,35

4170

Opak Seri Yıldız Uçlu Tornavida
Screwdriver, Opak Phillips

TS 59 - 5 ISO 8764
DIN ISO 8764

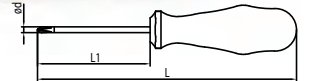

Krom vanadyum, Krom kaplı, PP saplı
Chrom vanadium, Chrom plated, PP handle

KOD CODE	σDxL1 mm	⊕	L mm	g	TL/Ad.
4170 18 0360	3x60	Ph0	130	15	10 9,60
4170 18 4580	4.5x80	Ph1	170	45	10 13,00
4170 18 6100	6x100	Ph2	200	70	10 15,60
4170 18 8150	8x150	Ph3	260	130	10 29,55

(★) İşaretili olan ürünler stoklarla sınırlıdır.
Limited with stocks.

DIY Elta Tools

4150

Opak Seri Tornavida Seti (6 parça)
Screwdriver Set, Opak (6 Pcs)



KOD CODE	İÇERİK CONTENTS	g		TL/Ad.
4150 00 8106	4x80 - 5x100 - 6x125 7x150 Düz uçlu / Flat	545	6	85,10
	4.5x80 - 6x100 Yıldız uçlu / Phillips			

4150

Opak Seri Tornavida Seti (7 parça)
Screwdriver Set, Opak (7 Pcs)



KOD CODE	İÇERİK CONTENTS	g		TL/Ad.
4150 00 8107	3x80 - 4x100 - 5x125 6x150 - 8x175 Düz uçlu / Flat	605	7	101,80
	4.5x80 - 6x100 Yıldız uçlu / Phillips			

4160

Ergonom Seri Düz Uçlu Tornavida
Screwdriver, Ergonom, Flat

TS ISO 2380-1
DIN ISO 2380-1

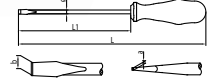

Krom vanadyum, Krom kaplı, Ucu siyah oksit, İki komponent saplı
Chrom vanadium, Chrom plated and black tips,
Two component handle

KOD CODE	ØDxL1 mm	a mm		L mm	g		TL/Ad.
		a	b				
★4160 17 0380	3x80	0.5	3	160	25	10	8,55
★4160 17 0480	4x80	0.8	4	170	40	10	9,70
★4160 17 0580	5x80	1.0	5.5	180	45	10	10,80
★4160 17 4100	4x100	0.8	4	190	45	10	10,65
★4160 17 5100	5x100	1.0	5.5	200	60	10	12,90
★4160 17 5125	5x125	1.0	5.5	225	65	10	14,90
★4160 17 6150	6x150	1.2	6.5	250	90	10	16,70
★4160 17 7150	7x150	1.2	8	260	130	10	19,70

4180

Ergonom Seri Yıldız Uçlu Tornavida
Screwdriver, Ergonom, Phillips

TS 59 -5 ISO 8764-1
DIN ISO 8764

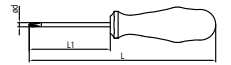

Krom vanadyum, Krom kaplı, Ucu siyah oksit, İki komponent saplı
Chrom vanadium, Chrom plated and black tips,
Two component handle.

KOD CODE	ØDxL1 mm	+	L mm	g		TL/Ad.
★4180 18 0360	3x60	Ph0	140	25	10	9,95
★4180 18 4510	4.5x100	Ph1	190	60	10	14,55
★4180 18 8150	8x150	Ph3	260	130	10	29,75

(★) İşaretili olan ürünler stoklarla sınırlıdır.
Limited with stocks.

4170

Değişken Uçlu Tornavida
Screwdriver - Reversible

TSEK

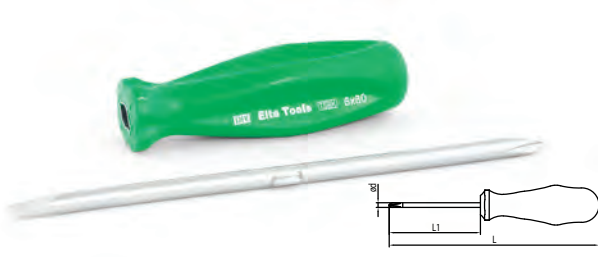

Krom vanadyum, Krom kaplı, PP saplı
Chrom vanadium, Chrom plated, PP handle

KOD CODE	øDxL1 mm	a x b mm	+	L mm	g	TL/Ad.
4170 17 0680	6x80	6x1.2	Ph2	170	60	10, 19,60

4501

Elektronikçi Tip (Klemens) Düz Uçlu Tornavida
Electronic Screwdriver, Flat



Krom vanadyum, Krom kaplı, Ucu siyah oksit, PP saplı
Chrom vanadium, Chrom plated and black tips, PP handle

KOD CODE	øDxL1 mm	-		L mm	g	TL/Ad.
		a mm	b mm			
★4501 17 3150	3x150	0.5	3	230	20	10, 12,90
★4501 17 4150	4x150	0.8	4	230	25	10, 13,70

4552

Elektrik Kontrol Kalemii
Voltage Tester

TS 13108

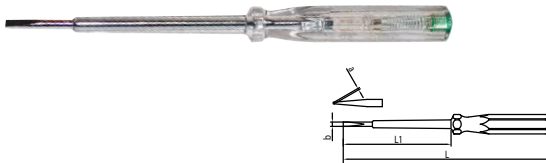

Krom vanadyum, Krom kaplı, Selüloz asetat saplı
Chrom vanadium, Chrom plated, Cellulose acetate handle

KOD CODE	L mm	-		L1 mm	g	TL/Ad.
		a mm	b mm			
★4552 17 0190	190	0.8	4	100	35	10, 14,55

4771

Lokma Uçlu Tornavida (mm)
Nut Spinner (mm)

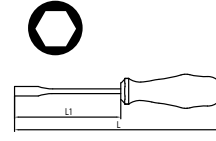

Krom vanadyum, Krom kaplı, PP saplı
Chrom vanadium, Chrom plated, PP handle

KOD CODE	mm	L mm	L1 mm	g	TL/Ad.
★4771 19 0090	9	235	125	115	10, 26,80
★4771 19 0110	11	235	125	135	10, 29,60

4811

Düz Bits
Slotted Bit



KOD CODE	-	L mm	g	TL/Ad.
★4811 20 0645	0.6x4.5	25	5	10, 1,70
★4811 20 0855	0.8x5.5	25	5	10, 1,70
★4811 20 1265	1.2x6.5	25	5	10, 1,70
★4811 20 5645	0.6x4.5	50	10	10, 2,60
★4811 20 5855	0.8x5.5	50	10	10, 2,60
★4811 20 5265	1.2x6.5	50	10	10, 2,60

4821

Yıldız Bits
Phillips Bit



KOD CODE	+	L mm	g	TL/Ad.
★4821 21 0001	Ph1	25	5	10, 1,50
★4821 21 0002	Ph2	25	5	10, 1,50
★4821 21 0003	Ph3	25	5	10, 1,50
★4821 21 0011	Ph1	50	10	10, 3,15
★4821 21 0013	Ph3	50	10	10, 3,15

4831

Torx® Bits
Torx® Bit



KOD CODE	*	L mm	g	TL/Ad.
★4831 21 0025	T25	25	5	10, 2,10
★4831 21 0027	T27	25	5	10, 2,10
★4831 21 0030	T30	25	5	10, 2,10
★4831 21 0040	T40	25	5	10, 2,10
★4831 21 0125	T25	50	10	10, 3,55
★4831 21 0127	T27	50	10	10, 3,55
★4831 21 0140	T40	50	10	10, 3,55

(★) İşaretili olan ürünler stoklarla sınırlıdır.
Limited with stocks.

DIY Elta Tools

4908

Allen Anahtar Altı Köşe (mm)
Hex Key Wrench (mm)

TS ISO 2936
DIN ISO 2936

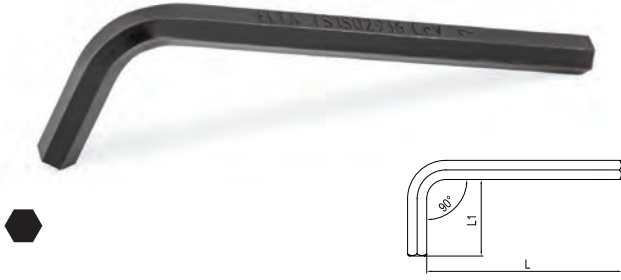

14-17-19mm ölçüler Krom kaplı
14-17-19 size chrome plated

Krom vanadyum, Siyah Oksit Kaplı
Chrom vanadium, Black finish

KOD CODE	mm	L mm	L1 mm	g		TL/Ad.
4908 22 0015	1.5	45	14	1.5	10	1,40
4908 22 0020	2	50	16	2	10	1,75
4908 22 0025	2.5	55	18	4	10	2,10
4908 22 0030	3	60	20	6	10	2,40
4908 22 0035	3.5	66	22	8	10	2,60
4908 22 0040	4	73	24	10	10	3,00
4908 22 0050	5	80	28	20	10	3,15
4908 22 0060	6	86	30	30	10	4,10
4908 22 0070	7	92	32	40	10	5,80
4908 22 0080	8	98	34	55	10	6,75
4908 22 0090	9	104	36	75	10	9,50
4908 22 0100	10	112	40	100	10	10,25
4908 22 0120	12	120	45	160	10	15,00
★4908 22 0140	14	137	53	250	5	22,45
★4908 22 0170	17	155	60	425	5	39,50
★4908 22 0190	19	174	67	610	5	51,55

4908

Allen Anahtar Takım Altı Köşe (mm)
Hex Key Wrench Set (mm)

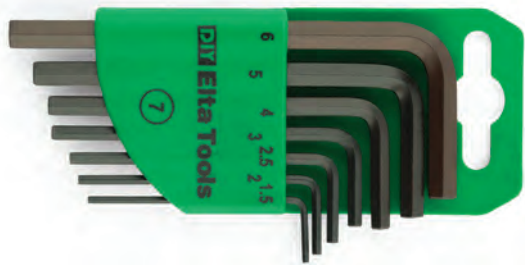

KOD CODE	İÇERİK CONTENTS	g		TL/Ad.
4908 00 3107	1.5 - 2 - 2.5 - 3 - 4 - 5 - 6	80	7	17,90
4908 00 3109	1.5 - 2 - 2.5 - 3 - 4 5 - 6 - 8 - 10	235	9	34,90
4908 00 3110	1.5 - 2 - 2.5 - 3 - 4 - 5 6 - 8 - 10 - 12	395	10	49,90

4911

Torx® Allen Anahtar
Torx® Key Wrench

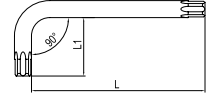

Krom vanadyum, Çinko kaplı
Chrom vanadium, Zinc Plated

KOD CODE		L mm	L1 mm	g		TL/Ad.
★4911 22 0006	T6	42	16	2	10	7,60
★4911 22 0007	T7	48	16	2	10	7,60
★4911 22 0008	T8	48	16	3	10	7,60
★4911 22 0009	T9	48	16	3	10	8,35
★4911 22 0015	T15	54	18	5	10	8,60
★4911 22 0020	T20	57	19	5	10	9,00
★4911 22 0025	T25	60	20	10	10	9,00
★4911 22 0027	T27	64	21	15	10	9,00
★4911 22 0030	T30	70	24	20	10	9,70
★4911 22 0040	T40	76	26	30	10	10,25
★4911 22 0045	T45	83	29	40	10	12,60
★4911 22 0050	T50	95	32	60	10	14,35
★4911 22 0055	T55	108	35	125	10	20,00
★4911 22 0060	T60	120	38	185	10	27,60

4915

Kaset Allen Anahtar Takımı (6 Parça, mm)
Hex Key Wrench Folding Set (6 Pcs, mm)



Krom vanadyum, Siyah oksit kaplı
Chrom vanadium, Black finish

KOD CODE	İÇERİK CONTENTS	g		TL/Ad.
4915 00 6106	2.5 - 3 - 4 - 5 - 6 - 8	175	1	74,00

4922

T Tipi Allen Anahtar (mm) Hex Key Wrench T - Handle (mm)



Krom vanadyum, Siyah Oksit Kaplı, PP saplı
Chrom vanadium, Black finish, PP handle

KOD CODE	mm	L mm	L1 mm	g	TL/Ad.	
4922 22 0025	2.5	110	14	15	5	17,15
4922 22 0030	3	125	18	20	5	17,25
4922 22 0040	4	140	22	30	5	17,40
4922 22 0050	5	155	26	55	5	19,80
4922 22 0060	6	170	30	75	5	21,75
4922 22 0070	7	185	34	115	5	22,45
4922 22 0080	8	200	38	150	5	27,10
4922 22 0100	10	220	48	270	5	47,35

4922

T Tipi Allen Anahtar Takımı (8 Parça, mm) Hex Key Wrench T - Handle Set (8 Pcs, mm)



KOD CODE	İÇERİK CONTENTS	g	TL/Ad.	
4922 00 8108	2.5 - 3 - 4 - 5 6 - 7 - 8 - 10	730	8	190,25

5011

Iskarpela (Düz) Wood Chisel

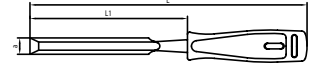

Özel alaşımli çelik, Uç indüksiyonda sertleştirilmiş, PP Saplı
Special steel, induction hardened tips, PP Handle

KOD CODE	a mm	L mm	L1 mm	g	TL/Ad.	
5011 23 0006	6	275	155	105	5	27,65
5011 23 0008	8	275	155	125	5	29,25
5011 23 0010	10	275	155	140	5	30,95
5011 23 0012	12	275	155	140	5	34,00
5011 23 0014	14	275	155	145	5	35,15
5011 23 0016	16	275	155	165	5	37,55
5011 23 0018	18	275	155	165	5	40,75
5011 23 0020	20	275	155	165	5	45,25
5011 23 0022	22	275	155	180	5	49,15
5011 23 0024	24	275	155	205	5	53,00
5011 23 0026	26	275	155	205	5	55,00
★5011 23 0028	28	275	155	205	5	56,80
5011 23 0030	30	275	155	205	5	58,65

5501

Düz Keski Flat Cold Chisel

TS 492
DIN ISO 6450

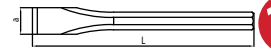

Krom vanadyum, Elektrostatik boyanmış
Chrom vanadium, Electrostatically painted

KOD CODE	L mm	a	mm	g	TL/Ad.	
★5501 23 0100	100	10	10	50	5	20,65
★5501 23 0125	125	10	10	70	5	23,45
★5501 23 0150	150	14	12	140	5	30,95
★5501 23 0175	175	18	12	170	5	34,85
★5501 23 0200	200	20	16	295	5	44,55
★5501 23 0250	250	22	16	370	5	54,75
★5501 23 0300	300	24	20	645	5	87,75

(★) İşaretili olan ürünler stoklarla sınırlıdır.
Limited with stocks.

DIY Elta Tools

5521

Tırnak Keski
Cross Cut Chisel

TS 492/1



Krom vanadyum, Elektrostatik boyanmış
Chrom vanadium, Electrostatically painted

KOD CODE	L mm	a mm	mm	g	TL/Ad.
★5521 23 0125	125	5	10	70	10 20,20
★5521 23 0150	150	6	12	110	10 26,95

5546

Konik Pim Zımba
Drift Punch

TS 2338
DIN 6448

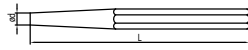

Krom vanadyum, Elektrostatik boyanmış
Chrom vanadium, Electrostatically painted

KOD CODE	L mm	L inch	øD mm	mm	g	TL/Ad.
★5546 24 0002	120	4 3/4"	2	10	55	10 15,95
★5546 24 0003	120	4 3/4"	3	10	60	10 15,95
★5546 24 0004	120	4 3/4"	4	10	60	10 15,95
★5546 24 0005	120	4 3/4"	5	10	65	10 15,95
★5546 24 0006	120	4 3/4"	6	10	65	10 15,95
★5546 24 0007	120	4 3/4"	7	12	100	10 18,35
★5546 24 0008	120	4 3/4"	8	12	100	10 18,35
★5546 24 0009	120	4 3/4"	9	12	105	10 20,15
★5546 24 0010	120	4 3/4"	10	12	105	10 20,15

5551

Düz Pim Zımba
Split Pin Punch

TS 2338
DIN 6450

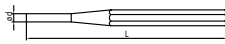

Krom vanadyum, Elektrostatik boyanmış
Chrom vanadium, Electrostatically painted

KOD CODE	L mm	øD mm	g	TL/Ad.
★5551 24 0002	115	2	30	5 21,15
★5551 24 0006	180	6	125	5 24,90
★5551 24 0008	200	8	155	5 24,90
★5551 24 0010	215	10	190	5 28,40

5701

Kayış Zımba
Belt Punch

DIN 7200

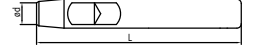

Krom vanadyum, Elektrostatik boyanmış
Chrom vanadium, Electrostatically painted

KOD CODE	ØD mm	L mm	g	TL/Ad.
★5701 24 0003	3	105	35	10 14,75
★5701 24 0004	4	105	45	10 15,50
★5701 24 0005	5	110	55	10 16,80
★5701 24 0006	6	110	60	10 17,15
★5701 24 0007	7	115	70	10 18,85
★5701 24 0008	8	115	80	10 20,10
★5701 24 0009	9	120	100	10 22,40
★5701 24 0010	10	120	115	10 23,90
★5701 24 0011	11	125	130	5 25,60
★5701 24 0012	12	125	145	5 30,70
★5701 24 0013	13	130	160	5 32,40
★5701 24 0014	14	130	170	5 35,50
★5701 24 0015	15	135	250	5 40,75
★5701 24 0016	16	135	300	5 44,60
★5701 24 0017	17	140	345	5 48,80
★5701 24 0018	18	145	405	5 50,25
★5701 24 0019	19	145	410	5 57,90
★5701 24 0020	20	145	440	5 61,65

5801

Tesviyeci Çekiç
Machinist Hammer

TS 5
DIN 1041

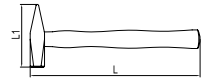

Özel alaşımlı çelik, İndüksiyonda sertleştirilmiş
Special steel, Induction hardened

KOD CODE	L mm	L1 mm	g	TL/Ad.
★5801 25 0100	260	82	100	145 10 27,65
★5801 25 0200	280	95	200	245 10 37,25
★5801 25 0500	320	118	500	565 5 57,40
★5801 25 1000	360	135	1000	1145 5 88,05
★5801 25 1500	380	145	1500	1615 5 119,75
★5801 25 2000	400	150	2000	2300 5 147,35

(★) İşaretili olan ürünler stoklarla sınırlıdır.
Limited with stocks.

5851

Plastik Çekiç
Plastic Hammer

TS 5

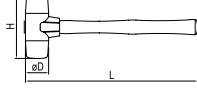

Yedek parça sayfa 199
Spare parts page 199

Darbeye dayanıklı, kolay değiştirilebilir başlık
Durable and easily changeable heads

KOD CODE	L mm	øD mm	H mm	g	TL/Ad.
★5851 25 0030	300	30	100	335	5 44,25

6351

Levye Oluklu
Tyre Lever, Straight

TSEK



Krom vanadyum, Krom kaplı
Chrom vanadium, Chrom plated

KOD CODE	L mm	L inch	g	TL/Ad.
6351 26 0400	400	16"	435	5 37,10
6351 26 0500	500	20"	680	5 52,65
6351 26 0600	600	24"	970	5 62,05

5884

Plastik Şerit Metre
Plastic Measuring tapes



KOD CODE	ÖLÇÜ SIZE	g	TL/Ad.
5884 26 0003	3	95	5 13,15
5884 26 0005	5	195	5 19,00

5891

Testere Kolu
Hacksaw Frame

DIN 6473



KOD CODE	L mm	g	TL/Ad.
5891 26 0830	300	345	5 49,30

6721

Bağ Makası (Lüks)
Pruning Shears (Lux)



Özel alaşımli çelik, Kesici ağızlar indüksiyonda sertleştirilmiş, Daldırma PVC izoleli
Special steel, Cutters induction hardened, PVC dipped

KOD CODE	L mm	L inch	g	TL/Ad.
6721 27 0205	205	8"	290	5 66,20

6722

Bağ Makası (Hafif Tip)
Pruning Shears (Light)



Alüminyum gövde, Daldırma PVC izoleli
Aluminum forged body, PVC dipped

KOD CODE	L mm	L inch	g	TL/Ad.
6722 27 0220	220	8 5/8"	240	5 105,10

11

DIY Elta Tools

6730

Çim Kesme Makası (Düz Ağız)
Grass Shears (Straight)



KOD CODE	L mm	L inch	g	TL/Ad.
6730 27 0550	550	21 5/8"	915	5 90,00

6731

Çim Kesme Makası (Eğri Ağız)
Grass Shears (Wave Edges)



11

KOD CODE	L mm	L inch	g	TL/Ad.
6731 27 0650	650	25 5/8"	1195	5 146,20

8011

Teşhir Panosu
Display



Sacdan imal edilmiş, Fırın boyalı
Made from metal sheet, Electrostatic paint

KOD CODE	SIZE mm	Cinsi	g	TL/Ad.
8011 31 6001	500x1000x2250	Boş	14000	1 1200,00

(*) İşaretili olan ürünler stoklarla sınırlıdır.
Limited with stocks.

IZELTAS®

YEDEK PARÇALAR

SPARE PARTS

Yedek Parçalar
Spare Parts



0600

Kurbağacık Anahtar ve Ayarlı Montaj Anahtarları Yedek Parçaları Adjustable Wrench, Spare Parts

	KOD CODE	L mm	L inch	g	TL/Ad.
Somun Nut	0600 01 0206	160	6"	5	10 5,75
	0600 01 0208	208	8"	10	10 6,80
	0600 01 0210	260	10"	10	10 9,10
	0600 01 0212	308	12"	20	10 12,40
	0600 01 0215	388	15"	65	10 17,95
Vida Bolt	0600 01 0306	160	6"	3	10 1,35
	0600 01 0308	208	8"	5	10 2,15
	0600 01 0310	260	10"	5	10 2,65
	0600 01 0312	308	12"	10	10 3,55
	0600 01 0315	388	15"	20	10 4,55
Yay Spring	0600 01 0406	160	6"	1	10 1,00
	0600 01 0408	208	8"	1	10 1,00
	0600 01 0410	260	10"	1	10 1,00
	0600 01 0412	308	12"	1	10 1,00
	0600 01 0415	388	15"	3	10 1,00

2100

Stilson Anahtar Yedek Parçaları Stillson Wrench Spare Part

	KOD CODE	ÖLÇÜ FOR	g	TL/Ad.	
Çene Jaw	2100 10 0108	8"	80	5 35,30	
	2100 10 0110	10"	180	5 52,35	
	2100 10 0112	12"	320	5 58,40	
	2100 10 0114	14"	400	5 70,45	
	2100 10 0118	18"	575	5 94,75	
	2100 10 0124	24"	980	5 135,75	
	Bağlantı Parçası Connection Part	2100 10 0208	8"	60	5 54,20
		2100 10 0210	10"	95	5 80,45
2100 10 0212		12"	100	5 88,15	
2100 10 0214		14"	195	5 106,45	
2100 10 0218		18"	345	5 122,00	
2100 10 0224		24"	445	5 182,40	
Somun Nut		2100 10 0308	8"	10	5 26,20
	2100 10 0310	10"	30	5 28,90	
	2100 10 0312	12"	25	5 30,20	
	2100 10 0314	14"	45	5 33,70	
	2100 10 0318	18"	75	5 46,60	
	2100 10 0324	24"	105	5 50,95	

12 2300

Zincirli Boru Anahtarları Yedek Zinciri Spare Chain

	KOD CODE	ØD mm	g	TL/Ad.
	★2300 10 1015	1 1/2"	240	1 191,70
	★2300 10 1120	12"	4625	1 2006,10

2110

Ağır Tip Boru Anahtarları Yedek Parçaları Pipe Wrench, Heavy Duty Spare Parts

	KOD CODE	ÖLÇÜ FOR	g	TL/Ad.
Çene Jaw	2110 10 0108	8"	100	5 62,50
	2110 10 0110	10"	205	5 76,00
	2110 10 0112	12"	235	5 150,00
	2110 10 0114	14"	400	5 160,00
	2110 10 0118	18"	675	5 170,00
	2110 10 0124	24"	900	5 255,00
	2110 10 0136	36"	1820	5 510,00
	2110 10 0148	48"	3410	5 840,00
Somun Nut	2110 10 0308	8"	10	5 20,50
	2110 10 0310	10"	25	5 21,50
	2110 10 0312	12"	35	5 23,50
	2110 10 0314	14"	40	5 28,50
	2110 10 0318	18"	65	5 38,00
	2110 10 0324	24"	115	5 58,00
	2110 10 0336	36"	230	5 107,50
	2110 10 0348	48"	305	5 172,50

Alt Çene ve Pim Lower Jaw and Pin

2110 10 0408	8"	15	5 64,00
2110 10 0410	10"	40	5 71,00
2110 10 0412	12"	60	5 80,00
2110 10 0414	14"	60	5 82,50
2110 10 0418	18"	90	5 85,40
2110 10 0424	24"	125	5 94,00
2110 10 0436	36"	225	5 150,00
2110 10 0448	48"	285	5 202,50

2201

Maşalı Boru Anahtarları Yedek Somun Nut

	KOD CODE	ÖLÇÜ FOR	g	TL/Ad.
	2201 10 0110	1"	25	10 6,00
	2201 10 0115	1 1/2"	40	10 7,55
	2201 10 0120	2"	60	10 10,05
	2201 10 0130	3"	75	10 13,50
	2201 10 0140	4"	75	10 15,85

2350

Demir Kesme Makası Yedek Bolt Cutters Spare Part

	KOD CODE	ÖLÇÜ SIZE	KAPASİTE CAPACITY Ø mm	g	TL/Ad.
	2350 27 0118	18"	6 - 8	850	1 165,20
	2350 27 0124	24"	8 - 10	870	1 189,35
	2350 27 0130	30"	9 - 13	1250	1 335,20
	2350 27 0136	36"	11 - 16	1850	1 618,95

(★) İşaretli olan ürünler stoklarla sınırlıdır.
Limited with stocks.

5850

Plastik Çekiç Yedek Başlık Plastic Hammer Spare Head



KOD CODE	ØD mm	g	TL/Ad.
5850 25 0130	30	35	10
5850 25 0140	40	70	10
5850 25 0150	50	120	10

6400

Keser Sapı / Adze Handle



KOD CODE	L mm	g	TL/Ad.
6400 25 0001	400	140	10

5800

Tesfiyeci Çekiç Yedek Sapı (Kamalı) Hammer Handle (With Pin)



KOD CODE	L mm	g	g	TL/Ad.
5800 25 0001	260	100	60	10
5800 25 0002	280	200	60	10
5800 25 0003	300	300	95	10
5800 25 0005	320	500	100	10
5800 25 0010	360	1000	165	10
5800 25 0015	380	1500	185	10
5800 25 0020	400	2000	205	10

5865

Madırğa Sapı (Kamalı) Mallet Handle (With Pin)



KOD CODE	L mm	g	TL/Ad.
5865 25 0001	260	1000	10
5865 25 0002	280	1500	10

6410

Nacak Sapı (Kamalı) Hatchet Handle (With Pin)



KOD CODE	L mm	g	g	TL/Ad.
6410 25 0001	380	800	250	10

03755

Kablo Sıyrıcı Yedek Bıçağı Cable Strippers Spare Blade



KOD CODE	ÖLÇÜ SİZE	g	TL/Ad.
03755 50 625	Tek 6/300 Çok 1,5/25	25	5

06375

Ayarlı Yağ Filtresi Sökeceği Yedek Kelepçe Adjustable Slot Type Oil Filter Wrench Spare Clamp



KOD CODE	Ø mm	g	TL/Ad.
06375 50 010	100	20	5



12

6230

Gres Pompası Yedek Ucu
Grease Gun Nozzle



500cc
300cc

KOD CODE	L mm	Ø mm	g	TL/Ad.
6230 26 2500	38	15	31	10
				8,60

Hortumu

Hose for
Grease Gun



KOD CODE	Ø mm	L mm	g	TL/Ad.
6230 26 3300	8	300	34	10
6230 26 3500	12	300	102	10
				11,25
				20,70

05898

HSS Testere Laması
Hacksaw Blade HSS



KOD CODE	ÖLÇÜ SIZE	g	TL/Ad.
05898 50 283	13x0.65x18	20	100
			13,15

05899

Bimetal Testere Laması
Hacksaw Blade Bimetal



KOD CODE	ÖLÇÜ SIZE	g	TL/Ad.
05899 50 283	13x0.65x18	20	100
			16,25

6735

12 Dal Budama Testeresi Yedek Bıçak
Spare Blade for Pruning Saw



KOD CODE	L mm	g	TL/Ad.
6735 27 1300	300	60	5
			91,10

06765

Plastik Boru Kesme Makası Yedek Bıçağı
Plastic Pipe Cutter Spare Blade



KOD CODE	ÖLÇÜ SIZE	g	TL/Ad.
06765 50 042	42	73	5
06765 50 063	63	105	5
			180,95
			336,10

6850

Mini Boru Kesici Bıçağı / Blade For Mini Tube Cutter
Standart Boru Kesici Bıçağı / Blade For Standard Tube Cutter
Teleskopik Boru Kesici Bıçağı / Blade For Telescopic Tube Cutter



KOD CODE	ÖLÇÜ SIZE	g	TL/Ad.
6850 28 1322	1/4" - 1 3/8"	5	10
			22,20

6865

Profesyonel Boru Kesici Bıçağı
Blade For Professional Tube Cutter



KOD CODE	ÖLÇÜ SIZE	g	TL/Ad.
6865 28 0150	1/8" - 2"	30	5
			41,85



7010-7020

Standart Çektirme Yedek Parçaları Spare Parts For Standard Pullers

Uzatma Parçası / Connection Part, Extention



KOD CODE	L mm	KULLANILAN ÇEKTİRME FOR	g	TL/Ad.
7010 29 2033	200	8x10 - 12x10	415	64,50
7010 29 3033	300	16x15 - 20x15	890	112,30
7010 29 4033	400	25x20 - 35x20 37x20 - 52x20	2350	166,20

Kol / Arm



KOD CODE	KULLANILAN ÇEKTİRME FOR	g	TL/Ad.
7010 29 0822	8x10 - 12x10	110	48,50
7010 29 1622	16x15 - 20x15	330	84,45
7010 29 2522	25x20 - 35x20 52x20 - 37x20	775	148,10

Bağlantı Parçası / Connection Part



KOD CODE	KULLANILAN ÇEKTİRME FOR	g	TL/Ad.
7010 29 0833	8x10 - 12x10	160	24,40
7010 29 1633	16x15 - 20x15	325	42,25
7010 29 2533	25x20 - 35x20 52x20 - 37x20	930	74,00

Mil / Spindle



KOD CODE	KULLANILAN ÇEKTİRME FOR	g	TL/Ad.
7010 29 0844	8x10 - 12x10	185	44,35
7010 29 1644	16x15 - 20x15	555	84,85
7010 29 2544	25x20	1400	145,95
7010 29 3544	35x20 - 37x20	2185	190,15
7010 29 5244	52x20	3210	190,15

7030-7040

Master Çektirme Yedek Parçaları / Spare Parts For Master Puller

Kol / Arm



KOD CODE	KULLANILAN ÇEKTİRME FOR	g	TL/Ad.
7030 29 0822	8x8	110	26,50
7030 29 1222	12x12	215	36,80
7030 29 1622	16x16	345	65,80
7030 29 2322	23x20	580	89,50

Mil/Spindle



KOD CODE	KULLANILAN ÇEKTİRME FOR	g	TL/Ad.
7030 29 0844	8x8	180	36,00
7030 29 1244	12x12	360	53,05
7030 29 1644	16x16	680	58,60
7030 29 2344	23x20	1230	80,35

7070-7080

S Tipi Çektirme Yedek Parçaları Spare Parts For S Type Puller

Kol / Arm



KOD CODE	KULLANILAN ÇEKTİRME FOR	g	TL/Ad.
7070 29 2022	20x13	405	53,15

Mil / Spindle



KOD CODE	KULLANILAN ÇEKTİRME FOR	g	TL/Ad.
7070 29 2044	20x13	520	74,10

7050-7060

Batarya Çektirme Yedek Parçaları Spare Parts For Battery Pullers

Kol / Arm



KOD CODE	KULLANILAN ÇEKTİRME FOR	g	TL/Ad.
7050 29 0422	6x4	40	20,65
7050 29 0622	6x6	50	23,00
7050 29 0822	8x8	110	26,50

Mil / Spindle



KOD CODE	KULLANILAN ÇEKTİRME FOR	g	TL/Ad.
7050 29 0444	6x4	95	30,70
7050 29 0644	6x6	105	34,30
7050 29 0844	8x8	200	43,20

7090-7100

Üniversal Çektirme Yedek Parçaları Spare Parts For Universal Puller

Kol / Arm



KOD CODE	KULLANILAN ÇEKTİRME FOR	g	TL/Ad.
7090 29 2322	22x22	690	59,05

Mil / Spindle



KOD CODE	KULLANILAN ÇEKTİRME FOR	g	TL/Ad.
7090 29 2244	22x22	565	78,00

5851

Plastik Çekiç Yedek Başlık Plastic Hammer Spare Head



KOD CODE	ØD mm	g	TL/Ad.
★5851 25 0130	30	35	10,20
★5851 25 0140	40	70	14,70

(★) İşaretli olan ürünler stoklarla sınırlıdır.
Limited with stocks.



IZELTAS®

TİCARİ TEŞHİR ÜRÜNLERİ

COMMERCIAL DISPLAY PRODUCTS

Ticari Teşhir Ürünleri
Commercial Display Products

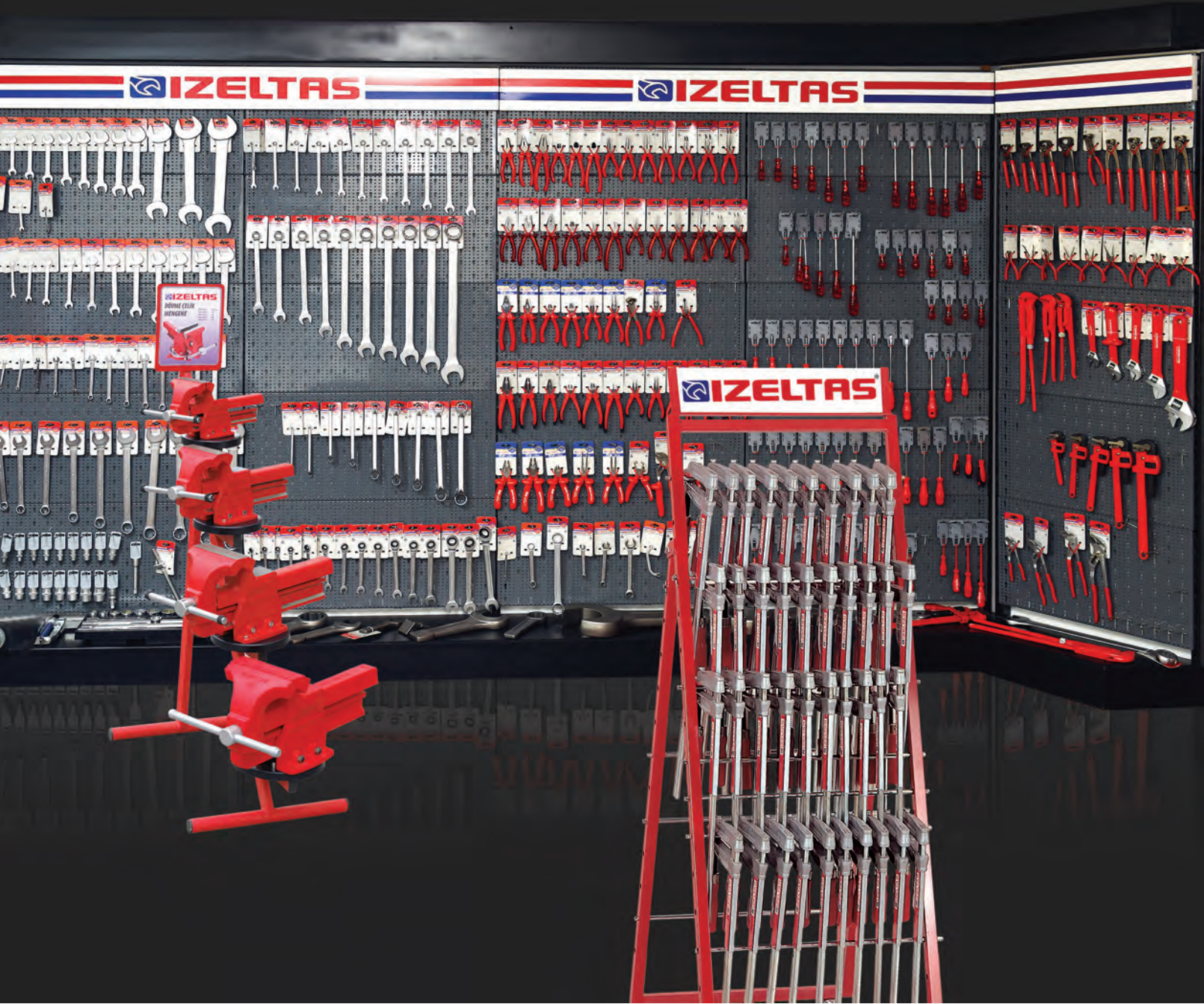

1113

1/2" Lokma Anahtar Sehpası
Display Frame for Sockets

**1/2"**

KOD CODE	ÖLÇÜ SIZE mm	g	TL/Ad.
1113 31 6100	175x360x605	5800	1 350,00

7010

Çektirme Sehpası
Display Frame For Pullers

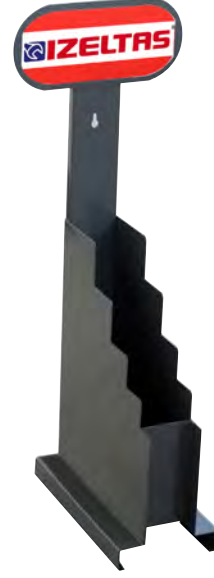

KOD CODE	İÇERİK CONTENTS	g	TL/Ad.
7010 31 6105	Boş - Empty	2000	1 100,00

2350

Demir Kesme Makası Sehpası
Display Frame for Bolt Cutters

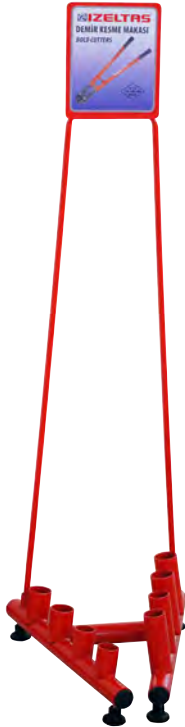
**7300**

İşkence Sehpası
Display Frame for Screw Clamps



KOD CODE	İÇERİK CONTENTS	g	TL/Ad.
2350 31 6104	Boş - Empty	7400	1 500,00

KOD CODE	ÖLÇÜ SIZE mm	g	TL/Ad.
7300 31 6150	100x520x1420	8000	1 429,75

13

8001 - 8002

Çatal ve Yıldız Anahtar Sehpası Display Frame For Wrenches



Sacdan imal edilmiş, Fırın boya
Made from metal sheet, Electrostatic paint

KOD CODE	ÖLÇÜ SIZE mm	g	İÇERİK CONTENTS	TL/Ad.
8001 31 6012	160x500	800	Çatal / Open Jaw	1 55,70
8002 31 6012	170x560	1000	Yıldız / Ring	1 69,50

8004

Dövme Çelik Mengene Sehpası Forged Steel Vice Frame



KOD CODE	İÇERİK CONTENTS	g	TL/Ad.
8004 31 6004	Boş - Empty	8000	1 532,75

8015

Tekerlekli Üçgen Teşhir Standı Triangular Display Frame



Sacdan imal edilmiş, Fırın boya
Made from metal sheet, Electrostatic paint

KOD CODE	ÖLÇÜ SIZE mm	g	TL/Ad.
8015 31 6001	520x1670	29500	1 755,50



13

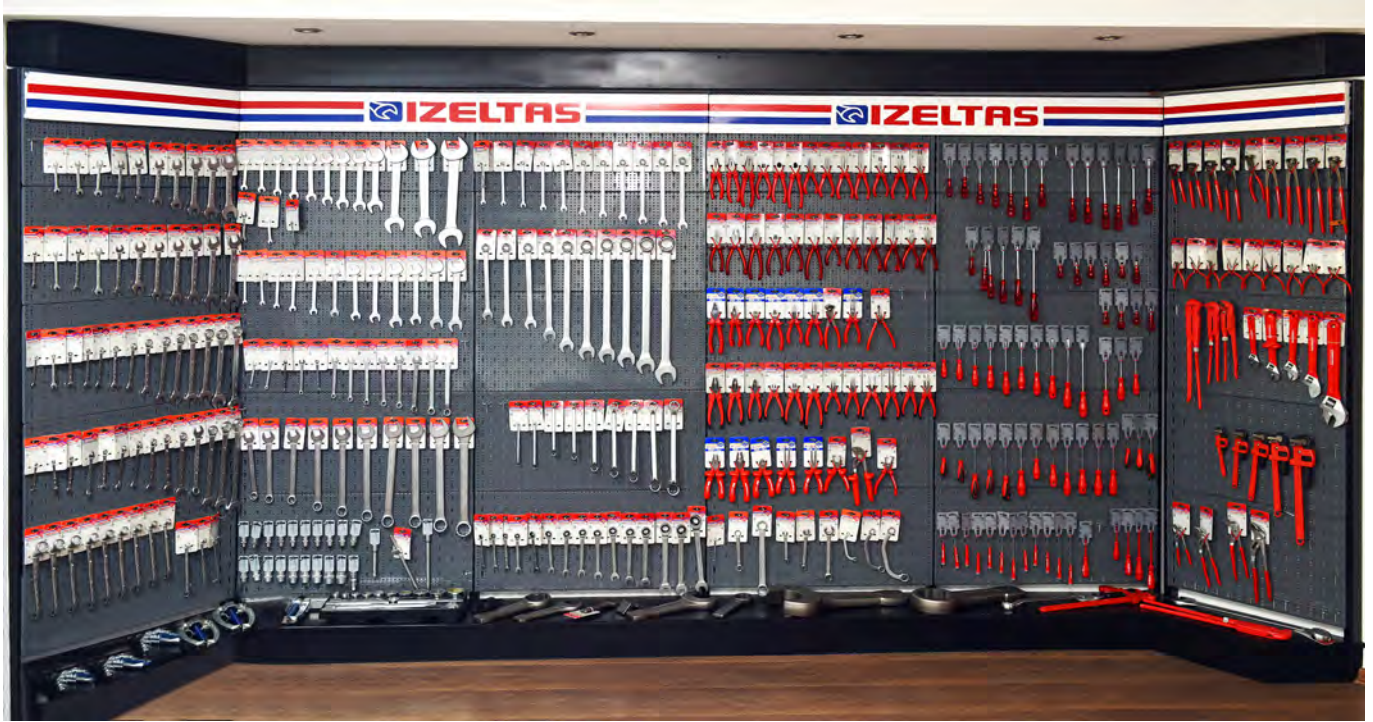

İzeltas El Aletleri Teşhir Panosu, satış noktaları için özel olarak dizayn edilmiştir. Kolayca monte edilebilen 19 ana parçadan oluşan panonun derinliği 46 cm, genişliği 100 cm, yüksekliği 220 cm'dir.

Etkili görünümü ve tüm ürünleri bir arada sergileme özelliği yanında, perakende satışlarda seçme kolaylığı sağlaması bakımından da önem taşımaktadır.

İzeltas's Product Exhibition Board has been specially designed for selling points. These boards have been formed from easily mountable 19 main parts and have the dimensions as following, width 46 cm, length 100 cm and height 220 cm.

Board features an impressive looking and displays the products all together, which makes it easy to choose desired tools during retail selling activities.

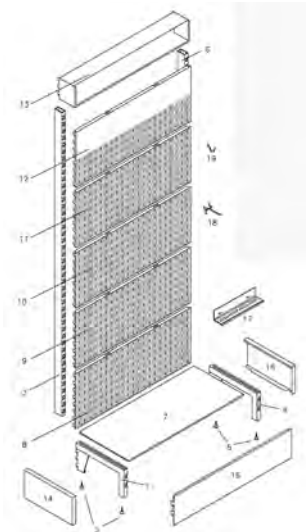



Montaj Sırası / Montage Order

1. Ayak / Stand right leg
2. Plastik ayak / Plastic leg
3. Kolon / Stand right column
4. Ayak / Stand left leg
5. Plastik ayak / Plastic leg
6. Kolon / Stand left column
7. Raf / Shelf
8. Delikli pano / Drilled panel
9. Delikli pano / Drilled panel
10. Delikli pano / Drilled panel
11. Delikli pano / Drilled panel
12. Yarım delikli pano / Half - drilled panel
13. Aydınlatma alınlığı / Illumination panel
14. Yan kapak / Side cover
15. Yan kapak / Side cover
16. Ön kapak / Front cover
17. Tornavida askısı / Screwdriver hanger
18. Büyük askı / Long hanger
19. Küçük askı / Short hanger

13

Büyük Pano Display Panel (Empty)

KOD CODE	ÖLÇÜ SIZE mm	Cinsi	 g		TL/Ad.
8010 31 6001	460x1000x2200	Boş/Empty	43000	1	1450,00

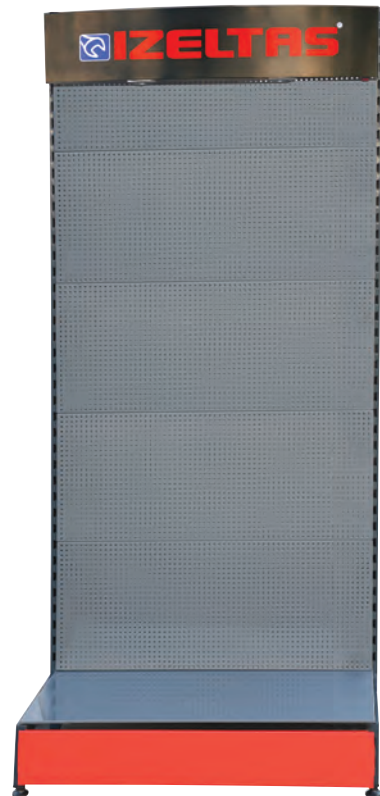

(★) İşaretili olan ürünler stoklarla sınırlıdır.
Limited with stocks.

TEKNİK BİLGİLER

TECHNICAL INFORMATION

Teknik Bilgiler
Technical Informations





Elektrik akımı geçme (1000V üzeri hariç) ihtimali olan tüm yerlerde IEC 60900'a göre izoleli uygun el aletleri kullanılmalıdır.
Hand tools with IEC 60900 compliant isolation must be used for any work involving risk of electrical current (excluding 1000V and above).



Tozlu ve çapaklı alanlarda mutlaka gözlük kullanınız.
Make sure to wear goggles in work areas with dust and burrs.



Lokma anahtarlarınızı uygun ölçülerdeki cıvata, en geniş yüzeyde dik olarak kullanınız. Lokma anahtarların cıvataya eğik olarak takılıp kullanılması, kavrama yüzeyini azaltarak ürünün kullanım ömrünü kısıltacaktır.
Use box wrenches with bolts of appropriate size, placed perpendicularly on the largest area of contact. Use of a box wrench at an angle will reduce the gripping surface and result in a shorter useful life.



Yüksek sesli ortamlarda mutlaka kulaklık kullanınız.
Make sure to wear ear protection in work areas with high levels of noise.



Çekici amacı dışında kendinden daha sert malzemelere vurmuyunuz, eğik olarak kullanmayınız. Mantarlaşmış bölgeleri mutlaka temizleyerek kullanınız.
Do not use a hammer outside its intended purpose or to hit objects harder than the hammer. Do not hit at an angle. Make sure to clean weakened parts before use.



Kimyasal madde içeren işlerde mutlaka eldiven ve maske kullanınız. Make sure to wear gloves and facemask for works involving chemical materials.

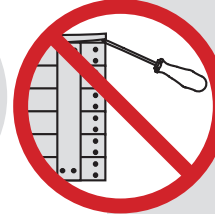

Tornavidayı amacı dışında sökme işlemlerinde kullanmayınız.
Do not use the screwdriver as a levering tool out of its intended purpose.



Anahtarlarınızı, ağız ölçüsüne uygun cıvatalarda kullanınız. Anahtar ve cıvata arasındaki ölçü uyumsuzluğu, üründe ağız aşınmasına neden olur.
Use wrenches with bolts of appropriate size. Size discrepancy between wrench and bolt will lead to wear on tool edge.



Tornavidayı amacı dışında keski gibi ya da darbeli olarak kullanmayınız.
Do not use the screwdriver as a chiselling tool or for impacting out of its intended purpose.



Anahtarların ağızına taşlama işlemi yapmayınız; sert cisimler sürterek müdahale etmeyiniz. Bu durum anahtarınızın ağız yapısını bozar.
Do not grind or expose the edge of wrenches to hard objects. This will deform the tool edge structure.



Dolapları çekerek değil iterek kullanınız.
Do not pull the set cabinets. Push to move the cabinets.



Anahtar gövdesine boru takarak kuvvet uygulamayınız. Anahtarınızın ağız yapısının bozulmasına, kırılmalara ve yaralanmalara neden olabilir.
Do not apply force to the wrench by attaching a pipe to the tool body. This may result in deformation of tool edge, breakage or injury.



Dolapların birden fazla çekmesini aynı anda açık bırakmayınız. Ağır merkezde değişerek dolabın devrilmesine neden olacaktır.
Do not leave multiple drawers of set cabinets open at the same time. This will move the centre of gravity and cause toppling.



Anahtar gövdesine çekiç ile darbe uygulamayınız. Ağız yapısında bozulmalara, kırılma ve yaralanmalara neden olabilir.
Do not hit the wrench body with a hammer. This may result in deformation of tool edge, breakage or injury.



Dolapların çekmecelerini ayağınızla kapatmaya ya da basamak, merdiven olarak kullanmaya çalışmayınız. Bu gibi durumlar yaralanmalara sebep olacaktır.
Do not use your foot to close a cabinet drawer or attempt to use cabinet drawers as a stepladder. Such actions will result in injury.

TEKNİK BİLGİLER/TECHNICAL DATA

ANAHTAR AĞZI ÖLÇÜLERİ VE VİDA ÇAPLARI SPANNER JAW WIDTH ACCROSS FLATS and THREAD DIAMETERS

mm	DIN ISO 272 ye göre metrik	DIN ISO 272 ye göre metrik	AF	Ağız Genişliği		Civata Çapı Whitw.	BS 916 1083	Ağız Genişliği	
				inch	mm			inch	mm
4	2		5/32	0,1562	3,97	8 BA		0,152	3,86
4,5	2,3					7 BA		0,172	4,87
5	2,5		3/16	0,1875	4,76	6 BA		0,193	4,90
5,5	3,5		7/32	0,2187	5,56	5 BA		0,220	5,59
6	26,8		1/4	0,2500	6,35	4 BA		0,248	6,30
						1/16 W		0,256	6,50
7	4		9/32	0,2812	7,14	3 BA		0,282	7,16
						3/32 W		0,297	7,54
7-8	5		5/16	0,3125	7,94	2 BA		0,324	8,23
9	5 Alt		11/32	0,3438	8,73	1/8 W	(3/16)	0,340	8,64
			3/8	0,3750	9,52	1 BA		0,365	9,27
8-10	6		13/32	0,4062	10,32	0 BA	(7/32)	0,413	10,49
11	7		7/16	0,4375	11,11	3/16 W	1/4	0,445	11,30
12									
10-13	8		1/2	0,5000	12,70	1/4 W	5/16	0,525	13,34
14*	8 Alt		9/16	0,5625	14,29				
15	10 KFZ		19/32	0,5938	15,08	5/16 W	3/8	0,600	15,24
16	10		5/8	0,6250	15,88				
13-15-17	10		11/16	0,6875	17,46				
18	12					3/8 W	7/16	0,710	18,03
15-18-19	12		3/4	0,7500	19,05				
20*			25/32	0,7812	19,84				
18-21	14		13/16	0,8125	20,64	7/16 W	1/2	0,820	20,83
22-24	14	12	7/8	0,8750	22,22				
23*						1/2 W	9/16	0,920	23,37
21-24*	16		15/16	0,9375	23,81				
25*-27*			1,	1,0000	25,40				
26*						9/16 W	5/8	1,010	25,65
27	18	16	1.1/16	1,0625	26,99				
27-28*-30						5/8 W	(11/16)	1,100	27,94
			1.1/8	1,1250	28,58				
27-30-34	20		1.3/16	1,1875	30,16	11/16 W	3/4	1,200	30,48
32-36-41	22	20	1.1/4	1,2500	31,75				
			1.5/16	1,3125	33,34	3/4 W	7/8	1,300	33,02
34	22		1.3/8	1,3750	34,92	13/16 W	(15/16)	1,390	35,31
36-41	24	22	1.7/16	1,4375	36,51				
38*			1.1/2	1,5000	38,10	7/8 W	1	1,480	37,59
41-46	27	24	1.5/8	1,6250	41,28				
			1.11/16	1,6875	42,86	1. W	1.1/8	1,670	42,42
			1.3/4	1,7500	44,45				
46-50	30	27	1.13/16	1,8125	46,04	1.1/8 W	1.1/4	1,860	47,24
			1.7/8	1,8750	47,62				
50-55	33	30	2,	2,0000	50,80				
			2.1/16	2,0625	52,39	1.1/4 W	1.3/8	2,050	52,07
55-60	36		2.3/16	2,1875	55,56				
			2.1/4	2,2500	57,15	1.3/8 W	1.1/2	2,220	56,39
60-65	39	36	2.3/8	2,3750	60,32				
			2.7/16	2,4375	61,91	1.1/2 W	1.5/8	2,410	61,21
65	42		2.9/16	2,5625	65,09	1.5/8	1.3/4	2,580	65,53
			2.5/8	2,6250	66,68				
70	45		2.3/4	2,7500	69,85	1.3/4 W	2,	2,760	70,10
			2.13/16	2,8125	71,44				
75	48		2.15/16	2,9375	74,61				
			3,	3,0000	76,20	(1.7/8 W)			76,70
80	52		3.1/8	3,1250	79,38	2. W	2.1/4	3,150	80,01
85	56		3.3/8	3,3750	85,72				
90	60		3.1/2	3,5000	88,90		2.1/2	3,550	90,17
95	64		3.3/4	3,7500	92,25				
			3.7/8	3,8750	98,42		2.3/4	3,890	98,81
100	68								
105	72		4.1/8	4,1250	104,78		3,	4,180	106,17
110	76		4.1/4	4,2500	107,95				
115*	80		4.1/2	4,5000	114,30		3.1/4	4,530	115,06

ANAHTAR İÇİN MİNİMUM DÖNDÜRME MOMENTLERİ TEST TORQUE VALUES FOR SPANNERS ISO 1711-1

0430	0440	0100	1800	1870
0320		0130		1874
0330				
0370				

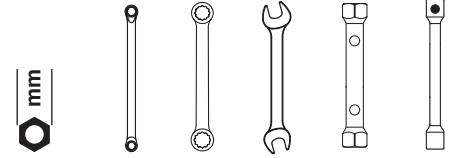

mm					
4			1,90		
4,5*			2,64		
5			3,55		
5,5			4,64		
6*	17,6	7,4	5,92	17,6	
7	25,2	11,4	9,12	25,2	
8	34,5	16,6	13,3	34,5	34,5
9*	45,5	23,0	18,4	45,5	45,5
10	58,1	31,0	24,8	58,1	58,1
11	72,7	40,4	32,3	72,7	72,7
12	89,1	51,5	41,2	89,1	89,1
13	107	64,5	51,6	107	107
14*	128	79,4	63,5	128	128
15	150	96,2	77,0	150	150
16	175	115	92,3	175	175
17	201	134	107	201	201
18	230	160	128	230	230
19*	261	186	149	261	261
20*	294	215	172	294	294
21	330	247	198	330	330
22*	368	281	225	368	368
23*	408	319	255	408	408
24	451	359	287	451	451
25*	496	402	322	496	496
26*	544	449	359	544	544
27	594	499	399	594	594
28*	647	552	442	647	647
30	760	670	536	760	760
32*	884	804	643	884	884
34	1019	951	761	1019	1019
36	1165	1117	994	1165	1165
41	1579	1442	1154	1579	1579
46	2067	1816	1453	2067	2067
50	2512	2145	1716	2512	2512
55	3140		2077	3140	3140
60	3849		2471	3849	
65	4021				
70	4658				
75	5394				

* Standart dışı/Not Standardised

* Standart dışı/Not Standardised

VİDA AĞIZ ÖLÇÜLERİ
GUIDELINE FOR SCREWDRIVERS

											
"Metrik Vida Metric screw"	M 1.6 (M 1.7)	M 2	M 2.3	(M 2.3) (M 2.6)	M 3	(M 3.5)	M 4	M 5	M 6	M 8	M 10
Düz başlı Vidalar Flat head screws	0.4 x 3 (3.2)	0.5 x 3.8	0.6 x 4.4	0.6 x 4.5 (5)	0.8 x 5.5	0.8 x 6	1 x 7	1.2 x 8.5	1.6 x 10	2 x 13	2.5 x 16
Düz başlı Vidalar Flat head screws	—	—	—	—	0.8 x 6	0.8 x 7	1 x 8	1.2 x 10	1.6 x 12	2 x 16	2.5 x 20
Düz başlı Vidalar (küçük) Flat head screws (small sizes)	—	—	—	0.4 x 3.5	0.5 x 4	0.5 x 4.5	0.6 x 5.5	0.8 x 6.5	1 x 8	1.2 x 10	1.6 x 13
Oval başlı Vidalar Oval head screws	0.4 x 3	0.5 x 3.8	—	0.6 x 4.7	0.8 x 5.6	—	—	—	—	—	—
Havşa başlı Vidalar Countersank head screws	0.4 x 3	0.5 x 3.8	—	0.6 x 4.7	0.8 x 5.6	0.8 x 6.5	1 x 7.5	1.2 x 9.2	1.6 x 11	2 x 14.5	2.5 x 18











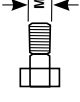
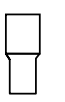



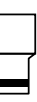

YILDIZ VİDALAR İÇİN UYGUN TORNAVİDA AĞIZ ÖLÇÜLERİ
SUITABLE TİPS FOR CROSS HEAD SCREWS

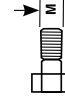
		
Yıldız Ağız Ölçüsü Cross Slot Size		Metrik Vidalar Metric Screw
0		M 1.6 - M 2
1		M 2 - M 2.5 - M 3
2		M 3.5 - M 5
3		M 6
4		M 8 - M 10

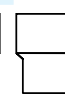

TEKNİK BİLGİLER/TECHNICAL DATA

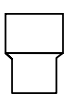
METRİK VIDALAR İÇİN LOKMA SEÇİMİ GUIDE TO METRIC SIZES COVERED BY SOCKET WRENCHES FOR EACH DRIVE

	1107 6,3	1110 10	1113 12,5	1119 20	1125 25
					
					
					
					

SIKMA / TEST TORK DEĞERLERİ TIGHTENING / TEST TORQUE VALUES

Önerilen (Bağlayıcı olmayan) civata sıkma torkları Nm (Newton Metre)
Suggested (Not Compulsory) Bolt Tightening Torque in Nm (Newton Meter)

Kalite Sınıfı DIN 267'ye Göre Sıkma Değerleri
Tightening Torques Values According to Quality Class DIN 267

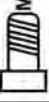
	4.6	5.6	6.9	8.8	10.9	12.9
M 2	0,123	0,162	0,314	0,373	0,520	0,628
M 2,2	0,196	0,265	0,510	0,598	0,843	1,010
M 2,5	0,284	0,373	0,726	0,863	1,206	1,451
M 3	0,441	0,588	1,128	1,344	1,883	2,256
M 3,5	0,677	0,902	1,736	2,060	2,893	3,481
M 4	1,000	1,344	2,599	3,040	4,315	5,148
M 5	1,916	2,648	5,099	6,031	8,483	10,200
M 6	3,432	4,511	8,728	10,300	14,710	17,652
M 7	5,590	7,453	14,220	17,162	24,517	28,439
M 8	8,238	10,787	21,575	25,497	35,304	42,168
M 10	16,67	21,575	42,168	50,014	70,608	85,317
M 12	28,44	38,246	73,550	87,279	122,60	147,10
M 14	45,11	60,801	116,70	138,30	194,20	235,40
M 16	69,63	93,163	178,5	210,80	299,10	357,90
M 18	95,12	127,50	245,20	289,3	411,90	490,30
M 20	135,3	180,45	384,10	411,90	578,60	696,30
M 22	182,4	245,16	470,70	559,00	784,50	941,40
M 24	230,5	308,91	598,20	711,00	1000	1196
M 27	343,2	460,90	887,50	1049	1481	1775
M 30	465,8	622,72	1206	1422	2010	2403
M 33	632,5	848,30	1628	1932	2716	3266
M 36	814,0	1089	2099	2481	3491	4197
M 39	1059	1412	2716	3226	4531	5443
M 42	1304	1746	3364	3991	5609	6727
M 45	1638	2177	4207	4992	7012	8414
M 48	1981	2638	5080	6021	8473	10150
M 52	2540	3393	6541	7747	10885	13092
M 56	3168	4227	8149	9650	13582	16279
M 60	3932	5247	10101	11964	16867	20202
M 64	4737	6306	12160	14416	20300	24320

Moment Değerleri Yağlanmış Civatalar İçin %20 Azaltılmalıdır.
Torque Values Should be Decreased of 20% for Lubricated Screws

TEKNİK BİLGİLER/TECHNICAL DATA

Ölçü Birimleri Measuring Units

Giga	G	1.000.000.000	=10 ⁹	1GW= 1 Milyar Watt
Mega	M	1.000.000	=10 ⁶	1 MW= 1 Milyon Watt
Kilo	k	1.000	=10 ³	1 kW= Bin Watt
Milli	m	0.001	=10 ⁻³	1 mm= Binde Bir Watt
Mikro	m	0.000001	=10 ⁻⁶	1 mm= 1 Milyonda Bir Watt
Nano	n	0.000000001	=10 ⁻⁹	1 nm= 1 Milyarda Bir Watt

Önemli Ölçülerin Değişim Tablosu Conversion Table For Essential Measuring Units

Uzunluk Length	Metre	m		
Kütle Weight	Kilogram	kg		
Zaman Time	Saniye	s		
Kuvvet Force	Newton	N	=kg m/s ²	1 N= 0.102 kp
Döndürme Mom. Torque	Newtonmetre			9.81 Nm= 1kpm
İş Enerjisi Work	Joule	J	=Nm	
Isı Enerjisi Heat	Joule	J		1 J= 0.239 cal
Güç Power	Watt	W	=Nm/s	1 kW= 1.36 PS=860 kcal/h
Basınç Pressure	Pascal	Pa	=N/m ²	100.000 Pa=1 bar=10 mWS
Elektrik Akımı Electricity Current	Amper	A		
Sıcaklık Temperature	Kelvin	K		1K= -272.15 °C

Döndürme Momenti Dönüşüm Tablosu Conversion Table For Bending Moments

Var Olan Ölçüler/ present units	İstenen Ölçüler / Wanted Units					
	=Ncm	=Nm	=kpcm	=kpm	=lbf.in.	=lbf.ft.
Ncm	1	0.01	0.10197	0.00102	0.0885	0.00738
Nm	100	1	10.197	0.10197	8.851	0.7376
kpcm	9.807	0.09807	1	0.01	0.868	0.0723
kpm	980.07	9.807	100	1	86.796	7.233
lbf.in.	11.298	0.11298	1.152	0.01152	1	0.0833
lbf.ft.	135.58	1.3558	13.825	0.13825	12	1

Newton-Metre ve Librefoot Dönüşüm Tablosu Conversion Table Of Newton-Meter And Librefoot (1 Nm=0.738 lbf.ft.)

Nm	ft.,lbs.									
	0	1	2	3	4	5	6	7	8	9
0	0	0.74	1.48	2.21	2.95	3.69	4.43	5.17	5.90	6.64
10	7.38	8.12	8.86	9.59	10.33	11.07	11.81	12.54	13.28	14.02
20	14.76	15.50	16.2	16.97	17.71	18.45	19.19	19.93	20.65	21.40
30	22.14	22.88	23.62	24.35	25.10	25.83	26.57	27.31	28.04	28.78
40	29.52	30.26	31.00	31.73	32.47	33.21	33.95	34.69	35.42	36.16
50	36.90	37.64	38.38	39.11	39.85	40.59	41.33	42.07	42.80	43.54
60	44.28	45.02	45.76	46.49	47.23	47.97	48.71	49.45	50.18	50.92
70	51.66	52.40	53.14	53.87	54.61	55.35	56.09	56.83	57.56	58.30
80	59.04	59.78	60.52	61.25	62.00	62.73	63.47	64.21	64.94	65.68
90	66.42	67.16	67.90	68.63	69.37	70.11	70.85	71.59	72.32	73.06
100	73.80	74.54	75.28	76.01	76.75	77.49	78.23	78.97	79.70	80.44

Librefoot ve Newton-Metre Dönüşüm Tablosu Conversion Table Of Librefoot And Newton-Meter (1 lbf.ft.=1.356 Nm)

ft.- lbs.	Nm									
	0	1	2	3	4	5	6	7	8	9
0	0	1.36	2.71	4.07	5.42	6.78	8.14	9.49	10.85	12.20
10	13.56	14.92	16.27	17.63	18.98	20.34	21.70	23.05	24.41	25.76
20	27.12	28.48	29.83	31.19	32.54	33.90	35.26	36.61	37.97	39.32
30	40.68	42.04	43.39	44.75	46.10	47.46	48.82	50.17	51.53	52.88
40	54.24	55.60	56.95	58.31	59.66	61.02	62.38	63.73	65.09	66.44
50	67.80	69.16	70.51	71.87	73.22	74.58	75.94	77.29	78.65	80.00
60	81.36	82.72	84.07	85.43	86.78	88.14	89.50	90.85	92.21	93.56
70	94.92	96.28	97.63	98.99	100.34	101.70	103.06	104.41	105.77	107.12
80	108.48	109.84	111.19	112.55	113.90	115.26	116.62	117.97	119.33	120.68
90	122.04	123.40	124.75	126.11	127.46	128.82	130.18	131.53	132.89	134.24
100	135.60	136.96	138.31	139.67	141.02	142.38	143.74	145.09	146.45	147.80

Newton-Metre ve Kilopound-Metre Dönüşüm Tablosu Conversion Table Of Newton-Meter and Kilopound-Meter (1 Nm=0.102 kpm)

Nm	kpm									
	0	1	2	3	4	5	6	7	8	9
0	0.00	1.02	2.04	3.06	4.08	5.10	6.12	7.14	8.16	9.18
100	10.20	11.22	12.24	13.26	14.28	15.30	16.31	17.33	18.35	19.37
200	20.39	21.41	22.43	23.45	24.47	25.49	26.51	27.53	28.55	29.57
300	30.59	31.61	32.63	33.65	34.67	35.69	36.71	37.73	38.75	39.77
400	40.79	41.81	42.83	43.85	44.87	45.89	46.91	47.93	48.95	49.97
500	50.99	52.00	53.02	54.04	55.06	56.08	57.10	58.12	59.14	60.16
600	61.18	62.20	63.22	64.24	65.26	66.28	67.30	68.32	69.34	70.36
700	71.38	72.40	73.42	74.44	75.46	76.48	77.50	78.52	79.54	80.56
800	81.58	82.60	83.62	84.64	85.66	86.68	87.70	88.71	89.73	90.75
900	91.77	92.79	93.81	94.83	95.85	96.87	97.89	98.91	99.93	100.95
1000	101.97	102.99	104.01	105.03	106.05	107.07	108.09	109.11	110.13	111.15



Sertlik Dönüşüm Tablosu

Hardness Conversion Table

Vickers Sertlik Hardness	Brinell Sertlik Hardness	Rockwell Sertlik Hardness		Çekme dayanımı Tensile Strength
		HRB	HRC	
HV 30	HB 30	HRB	HRC	sB N/mm ²
80	80.7	36.4	-	270
85	85	42.4	-	290
90	90	47.4	-	310
95	95	52.00	-	320
100	100	56.4	-	340
105	105	60.0	-	360
110	110	63.4	-	380
115	115	66.4	-	390
120	120	69.4	-	410
125	125	72.0	-	420
130	130	74.4	-	440
135	135	76.4	-	460
140	140	78.4	-	470
145	145	80.4	-	490
150	150	82.2	-	500
155	155	83.8	-	520
160	160	85.4	-	540
165	165	86.8	-	550
170	170	88.2	-	570
175	175	89.6	-	590
180	180	90.8	-	600
185	185	91.8	-	620
195	190	91.5	-	640
200	195	94.0	-	660
200	200	95.0	-	670
205	205	95.8	-	680
210	210	96.6	-	710
215	215	97.4	-	720
220	220	98.2	-	730
225	225	99.0	-	750
230	230	-	19.2	760
235	235	-	20.2	780
240	240	-	21.2	800
245	245	-	22.1	820
250	250	-	23.0	830
255	255	-	23.8	850
260	260	-	24.6	870
265	265	-	25.4	880
280	280	-	27.1	900
275	275	-	26.9	920
280	280	-	27.6	940
285	285	-	28.3	950
290	290	-	29.0	970
295	295	-	29.6	990
300	300	-	30.3	1010
310	310	-	31.5	1040
320	320	-	32.7	1080
330	330	-	33.8	1110

Vickers Sertlik Hardness	Brinell Sertlik Hardness	Rockwell Sertlik Hardness		Çekme dayanımı Tensile Strength
		HRB	HRC	
HV 30	HB 30	HRB	HRC	sB N/mm ²
340	340	-	34.9	1140
350	350	-	36.0	1170
360	359	-	37.0	1200
370	368	-	38.0	1260
380	376	-	38.9	1260
390	385	-	39.8	1290
400	392	-	40.7	1320
410	400	-	41.5	1350
420	408	-	42.4	1380
440	423	-	44.0	1430
450	430	-	44.8	1460
460	-	-	45.6	-
470	-	-	46.3	-
480	-	-	47.0	-
490	-	-	47.7	-
500	-	-	48.3	-
510	-	-	49.1	-
520	-	-	49.7	-
530	-	-	50.4	-
540	-	-	51.0	-
550	-	-	51.6	-
560	-	-	52.2	-
570	-	-	52.8	-
580	-	-	53.3	-
590	-	-	53.9	-
600	-	-	54.4	-
610	-	-	55.0	-
620	-	-	55.5	-
630	-	-	56.0	-
640	-	-	56.5	-
650	-	-	57.0	-
660	-	-	57.5	-
670	-	-	58.0	-
680	-	-	58.5	-
690	-	-	59.0	-
700	-	-	59.5	-
720	-	-	60.4	-
740	-	-	61.2	-
760	-	-	62.0	-
780	-	-	62.8	-
800	-	-	63.6	-
820	-	-	64.3	-
840	-	-	65.0	-
860	-	-	65.7	-
880	-	-	66.3	-
900	-	-	66.9	-
920	-	-	67.5	-
940	-	-	68.0	-

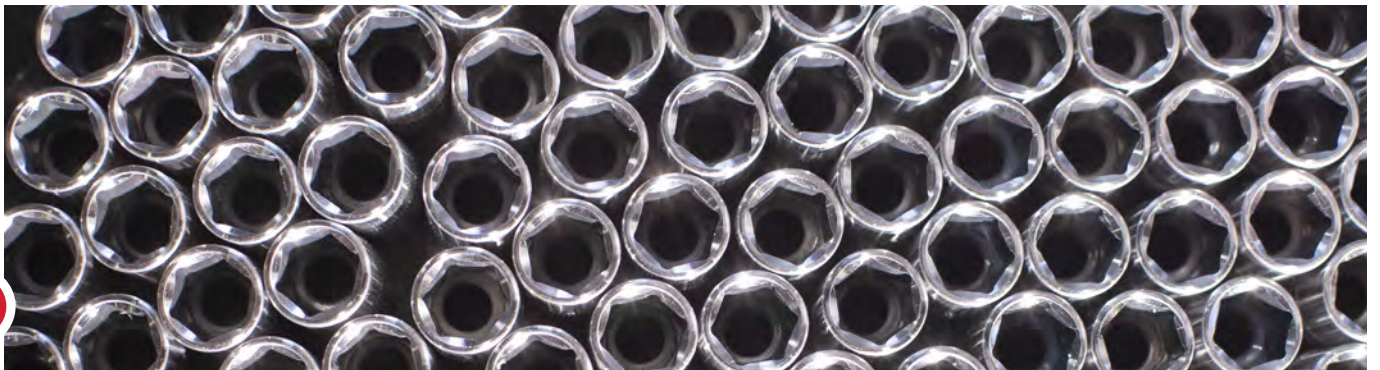

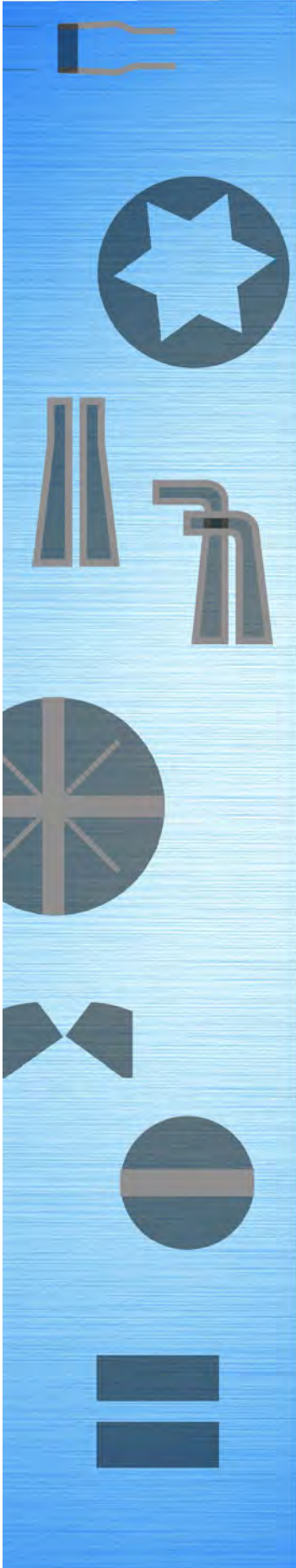
Semboller / Symbols

Anahtar Ağız
Size



Ağız Açıklığı
Opening Limit of Jaws



Altı Köşe Lokma Bijon
Anahtar Ağız
Six Point Sockets



Sekiz Köşe Anahtar Ağız
Eight Point Wrench



On iki Köşe Anahtar Ağız
Twelve Point Wrench



Kare Adaptör
Square Adapter



Kovan Anahtar
Tubular Socket Wrench



Bir Ağız Bijon Anahtar
Single Ended Rim Wrench



TORX® Lokma Anahtar
TORX Socket



Düz Uç
Flat Tip



Yıldız Uç
PHILLIPS® Tip



POZIDRIV® Yıldız Uç
POZIDRIV® Tip



TORX® Uç
TORX® Tip



Delikli TORX® Uç
TORX® with hole



Bits Tutucular
Bit Holders



Allen Anahtar
Hexagonal Allen Keys



Segman
Circlip



Gövde Ağırlık
Weight of Body



Tapa Anahtar
Wrench for Carter Case



İşence
Screw Clamp



Çektirme
Puller

in.	dec.in.	0"	1"	2"	3"	4"	5"	6"	7"	8"	9"	10"	11"
		millimeters (mm)											
0	0	0	25.400 0	50.800 0	76.200 0	101.600 0	127.000 0	152.400 0	177.800 0	203.200 0	228.600 0	254.000 0	279.400 0
1/64	0.015 625	0.396 9	25.796 9	51.196 9	76.596 9	101.996 9	127.396 9	152.796 9	178.196 9	203.596 9	228.996 9	254.396 9	279.796 9
1/32	0.031 25	0.793 8	26.193 8	51.593 8	76.993 8	102.393 8	127.793 8	153.193 8	178.593 8	203.993 8	229.393 8	254.793 8	280.193 8
3/64	0.046 875	1.190 6	26.590 6	51.990 6	77.390 6	102.790 6	128.190 6	153.590 6	178.990 6	204.390 6	229.790 6	255.190 6	280.590 6
1/16	0.062 5	1.587 5	26.987 5	52.387 5	77.787 5	103.187 5	128.587 5	153.987 5	179.387 5	204.787 5	230.187 5	255.587 5	280.987 5
5/64	0.078 125	1.984 4	27.384 4	52.784 4	78.184 4	103.584 4	128.984 4	154.384 4	179.784 4	205.184 4	230.584 4	255.984 4	281.384 4
3/32	0.093 75	2.381 2	27.781 2	53.181 2	78.581 2	103.981 2	129.381 2	154.781 2	180.181 2	205.581 2	230.981 2	256.381 2	281.781 2
7/64	0.109 375	2.778 1	28.178 1	53.578 1	78.978 1	104.378 1	129.778 1	155.178 1	180.578 1	205.978 1	231.378 1	256.778 1	282.178 1
1/8	0.125	3.175 0	28.575 0	53.975 0	79.375 0	104.775 0	130.175 0	155.575 0	180.975 0	206.375 0	231.775 0	257.175 0	282.575 0
9/64	0.140 625	3.571 9	28.971 9	54.371 9	79.771 9	105.171 9	130.571 9	155.971 9	181.371 9	206.771 9	232.171 9	257.571 9	282.971 9
5/32	0.156 25	3.968 8	29.368 8	54.768 8	80.168 8	105.568 8	130.968 8	156.368 8	181.768 8	207.168 8	232.568 8	257.968 8	283.368 8
11/64	0.171 875	4.365 6	29.765 6	55.165 6	80.565 6	105.965 6	131.365 6	156.765 6	182.165 6	207.565 6	232.965 6	258.365 6	283.765 6
3/16	0.187 5	4.762 5	30.162 5	55.562 5	80.962 5	106.362 5	131.762 5	157.162 5	182.562 5	207.962 5	233.362 5	258.762 5	284.162 5
13/64	0.203 125	5.159 4	30.559 4	55.959 4	81.359 4	106.759 4	132.159 4	157.559 4	182.959 4	208.359 4	233.759 4	259.159 4	284.559 4
7/32	0.218 75	5.556 2	30.956 2	56.356 2	81.756 2	107.156 2	132.556 2	157.956 2	183.356 2	208.756 2	234.156 2	259.556 2	284.956 2
15/64	0.234 375	5.953 1	31.353 1	56.753 1	82.153 1	107.553 1	132.953 1	158.353 1	183.753 1	209.153 1	234.553 1	259.953 1	285.353 1
1/4	0.25	6.350 0	31.750 0	57.150 0	82.550 0	107.950 0	133.350 0	158.750 0	184.150 0	209.550 0	234.950 0	260.350 0	285.750 0
17/64	0.265 625	6.746 9	32.146 9	57.546 9	82.946 9	108.346 9	133.746 9	159.146 9	184.546 9	209.946 9	235.346 9	260.746 9	286.146 9
9/32	0.281 25	7.143 8	32.543 8	57.943 8	83.343 8	108.743 8	134.143 8	159.543 8	184.943 8	210.343 8	235.743 8	261.143 8	286.543 8
19/64	0.296 875	7.540 6	32.940 6	58.340 6	83.740 6	109.140 6	134.540 6	159.940 6	185.340 6	210.740 6	236.140 6	261.540 6	286.940 6
5/16	0.312 5	7.937 5	33.337 5	58.737 5	84.137 5	109.537 5	134.937 5	160.337 5	185.737 5	211.137 5	236.537 5	261.937 5	287.337 5
21/64	0.328 125	8.334 4	33.734 4	59.134 4	84.534 4	109.934 4	135.334 4	160.734 4	186.134 4	211.534 4	236.934 4	262.334 4	287.734 4
11/32	0.343 75	8.731 2	34.131 2	59.531 2	84.931 2	110.331 2	135.731 2	161.131 2	186.531 2	211.931 2	237.331 2	262.731 2	288.131 2
23/64	0.359 375	9.128 1	34.528 1	59.928 1	85.328 1	110.728 1	136.128 1	161.528 1	186.928 1	212.328 1	237.728 1	263.128 1	288.528 1
3/8	0.375	9.525 0	34.925 0	60.325 0	85.725 0	111.125 0	136.525 0	161.925 0	187.325 0	212.725 0	238.125 0	263.525 0	288.925 0
25/64	0.390 625	9.921 9	35.321 9	60.721 9	86.121 9	111.521 9	136.921 9	162.321 9	187.721 9	213.121 9	238.521 9	263.921 9	289.321 9
13/32	0.406 25	10.318 8	35.718 8	61.118 8	86.518 8	111.918 8	137.318 8	162.718 8	188.118 8	213.518 8	238.918 8	264.318 8	289.718 8
27/64	0.421 875	10.715 6	36.115 6	61.515 6	86.915 6	112.315 6	137.715 6	163.115 6	188.515 6	213.915 6	239.315 6	264.715 6	290.115 6
7/16	0.437 5	11.112 5	36.512 5	61.912 5	87.312 5	112.712 5	138.112 5	163.512 5	188.912 5	214.312 5	239.712 5	265.112 5	290.512 5
29/64	0.453 125	11.509 4	36.909 4	62.309 4	87.709 4	113.109 4	138.509 4	163.909 4	189.309 4	214.709 4	240.109 4	265.509 4	290.909 4
15/32	0.468 75	11.906 2	37.306 2	62.706 2	88.106 2	113.506 2	138.906 2	164.306 2	189.706 2	215.106 2	240.506 2	265.906 2	291.306 2
31/64	0.484 375	12.303 1	37.703 1	63.103 1	88.503 1	113.903 1	139.303 1	164.703 1	190.103 1	215.503 1	240.903 1	266.303 1	291.703 1
1/2	0.5	12.700 0	38.100 0	63.500 0	88.900 0	114.300 0	139.700 0	165.100 0	190.500 0	215.900 0	241.300 0	266.700 0	292.100 0
33/64	0.515 625	13.096 9	38.496 9	63.896 9	89.296 9	114.696 9	140.096 9	165.496 9	190.896 9	216.296 9	241.696 9	267.096 9	292.496 9
17/32	0.531 25	13.493 8	38.893 8	64.293 8	89.693 8	115.093 8	140.493 8	165.893 8	191.293 8	216.693 8	242.093 8	267.493 8	292.893 8
35/64	0.546 875	13.890 6	39.290 6	64.690 6	90.090 6	115.490 6	140.890 6	166.290 6	191.690 6	217.090 6	242.490 6	267.890 6	293.290 6
9/16	0.562 5	14.287 5	39.687 5	65.087 5	90.487 5	115.887 5	141.287 5	166.687 5	192.087 5	217.487 5	242.887 5	268.287 5	293.687 5
37/64	0.578 125	14.684 4	40.084 4	65.484 4	90.884 4	116.284 4	141.684 4	167.084 4	192.484 4	217.884 4	243.284 4	268.684 4	294.084 4
19/32	0.593 75	15.081 2	40.481 2	65.881 2	91.281 2	116.681 2	142.081 2	167.481 2	192.881 2	218.281 2	243.681 2	269.081 2	294.481 2
39/64	0.609 375	15.478 1	40.878 1	66.278 1	91.678 1	117.078 1	142.478 1	167.878 1	193.278 1	218.678 1	244.078 1	269.478 1	294.878 1
5/8	0.625	15.875 0	41.275 0	66.675 0	92.075 0	117.475 0	142.875 0	168.275 0	193.675 0	219.075 0	244.475 0	269.875 0	295.275 0
41/64	0.640 625	16.271 9	41.671 9	67.071 9	92.471 9	117.871 9	143.271 9	168.671 9	194.071 9	219.471 9	244.871 9	270.271 9	295.671 9
21/32	0.656 25	16.668 8	42.068 8	67.468 8	92.868 8	118.268 8	143.668 8	169.068 8	194.468 8	219.868 8	245.268 8	270.668 8	296.068 8
43/64	0.671 875	17.065 6	42.465 6	67.865 6	93.265 6	118.665 6	144.065 6	169.465 6	194.865 6	220.265 6	245.665 6	271.065 6	296.465 6
11/16	0.687 5	17.462 5	42.862 5	68.262 5	93.662 5	119.062 5	144.462 5	169.862 5	195.262 5	220.662 5	246.062 5	271.462 5	296.862 5
45/64	0.703 125	17.859 4	43.259 4	68.659 4	94.059 4	119.459 4	144.859 4	170.259 4	195.659 4	221.059 4	246.459 4	271.859 4	297.259 4
23/32	0.718 75	18.256 2	43.656 2	69.056 2	94.456 2	119.856 2	145.256 2	170.656 2	196.056 2	221.456 2	246.856 2	272.256 2	297.656 2
47/64	0.734 375	18.653 1	44.053 1	69.453 1	94.853 1	120.253 1	145.653 1	171.053 1	196.453 1	221.853 1	247.253 1	272.653 1	298.053 1
3/4	0.75	19.050 0	44.450 0	69.850 0	95.250 0	120.650 0	146.050 0	171.450 0	196.850 0	222.250 0	247.650 0	273.050 0	298.450 0
49/64	0.765 625	19.446 9	44.846 9	70.246 9	95.646 9	121.046 9	146.446 9	171.846 9	197.246 9	222.646 9	248.046 9	273.446 9	298.846 9
25/32	0.781 25	19.843 8	45.243 8	70.643 8	96.043 8	121.443 8	146.843 8	172.243 8	197.643 8	223.043 8	248.443 8	273.843 8	299.243 8
51/64	0.796 875	20.240 6	45.640 6	71.040 6	96.440 6	121.840 6	147.240 6	172.640 6	198.040 6	223.440 6	248.840 6	274.240 6	299.640 6
13/16	0.812 5	20.637 5	46.037 5	71.437 5	96.837 5	122.237 5	147.637 5	173.037 5	198.437 5	223.837 5	249.237 5	274.637 5	300.037 5
53/64	0.828 125	21.034 4	46.434 4	71.834 4	97.234 4	122.634 4	148.034 4	173.434 4	198.834 4	224.234 4	249.634 4	275.034 4	300.434 4
27/32	0.843 75	21.431 2	46.831 2	72.231 2	97.631 2	123.031 2	148.431 2	173.831 2	199.231 2	224.631 2	250.031 2	275.431 2	300.831 2
55/64	0.859 375	21.828 1	47.228 1	72.628 1	98.028 1	123.428 1	148.828 1	174.228 1	199.628 1	225.028 1	250.428 1	275.828 1	301.228 1
7/8	0.875	22.225 0	47.625 0	73.025 0	98.425 0	123.825 0	149.225 0	174.625 0	200.025 0	225.425 0	250.825 0	276.225 0	301.625 0
57/64	0.890 625	22.621 9	48.021 9	73.421 9	98.821 9	124.221 9	149.621 9	175.021 9	200.421 9	225.821 9	251.221 9	276.621 9	302.021 9
29/32	0.906 25	23.018 8	48.418 8	73.818 8	99.218 8	124.618 8	150.018 8	175.418 8	200.818 8	226.218 8	251.618 8	277.018 8	302.418 8
59/64	0.921 875	23.415 6	48.815 6	74.215 6	99.615 6	125.015 6	150.415 6	175.815 6	201.215 6	226.615 6	252.015 6	277.415 6	302.815 6
15/16	0.937 5	23.812 5	49.212 5	74.612 5	100.012 5	125.412 5	150.812 5	176.212 5	201.612 5	227.012 5	252.412 5	277.812 5	303.212 5
61/64	0.953 125	24.209 4	49.609 4	75.009 4	100.409 4	125.809 4	151.209 4	176.609 4	202.009 4	227.409 4	252.809 4	278.209 4	303.609 4
31/32	0.968 75	24.606 2	50.006 2	75.406 2	100.806 2	126.206 2	151.606 2	177.006 2	202.406 2	227.806 2	253.206 2	278.606 2	304.006 2
63/64	0.984 375	25.003 1	50.403 1	75.803 1	101.203 1	126							

KALİTE GÜVENCE TESTLERİ / QUALITY ASSURANCE TEST



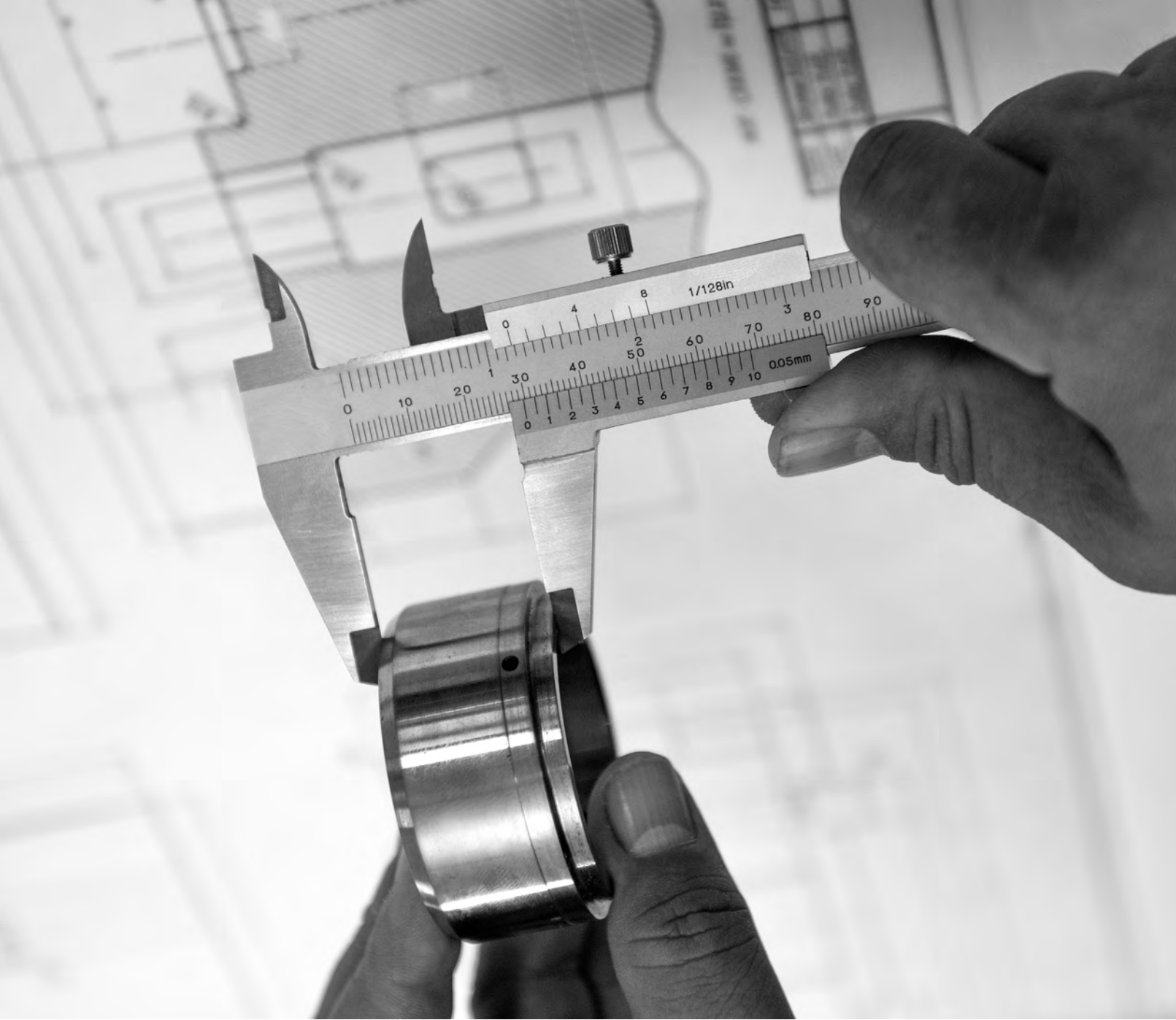

YASAL UYARILAR / LEGAL NOTIE

Bu katalog, önceki baskıların yerine geçer.
Katalog içeriğinde yer alan ürünlerin teknik özellikleri, görünümü, ölçüleri mevcut şartları temsil etmektedir. Firmanın, gerektiğinde ürünlerle ilgili değişiklik yapma hakkı saklıdır.
Ürün kataloğu ve içeriğindeki tüm görsellerin telif hakkı İZELTAŞ İzmir El Aletleri Sanayi ve Ticaret A.Ş.'ye aittir. İzinsiz kullanılması ve çoğaltılması yasaktır.
Kullanıcı, katalogdaki ürünlerle ilgili güvenlik uyarılarına uymakla yükümlüdür. Bu uyarılara uyulmaması durumunda ortaya çıkacak zararlardan firma sorumlu tutulamaz

Grafik Tasarım ve Düzenleme
İZELTAŞ İzmir El Aletleri Sanayi ve Ticaret A.Ş.

*This catalogue replaces previous editions.
Technical features, appearance and measurements of the products included in the catalogue represent the current conditions. The company reserves the right to make changes to the products if necessary.
The copyright of the product catalogue and all the images in the content belong to İZELTAŞ İzmir El Aletleri Sanayi ve Ticaret A.Ş.
Unauthorised use and reproduction is prohibited.
The user is obliged to comply with the safety instructions for the products in the catalogue. The company shall not be liable for any damages resulting from failure to comply with these instructions.*

Graphic Design and Editing
İZELTAŞ İzmir El Aletleri Sanayi ve Ticaret A.Ş.

İÇİNDEKİLER/INDEX

KOD CODE	ÜRÜN İSMİ PRODUCT NAME	SAYFA NO PAGE NUMBER	KOD CODE	ÜRÜN İSMİ PRODUCT NAME	SAYFA NO PAGE NUMBER	KOD CODE	ÜRÜN İSMİ PRODUCT NAME	SAYFA NO PAGE NUMBER
0100002108	8'Lİ ÇATAL İKİ AĞIZ ANAHTAR TAKIMI KISA BOY	41	0130010809	08X09 ÇATAL İKİ AĞIZ ANAHTAR UZUN BOY	42	0150010809	08X09 MM ELTA CATAL ANAHTAR	178
0100002112	12'Lİ ÇATAL İKİ AĞIZ ANAHTAR TAKIMI KISA BOY	41	0130010810	08X10 ÇATAL İKİ AĞIZ ANAHTAR UZUN BOY	42	0150011011	10X11 MM ELTA CATAL ANAHTAR	178
0100010405	04X05 ÇATAL İKİ AĞIZ ANAHTAR KISA BOY	41	0130010910	09X10 ÇATAL İKİ AĞIZ ANAHTAR UZUN BOY	42	0150011213	12X13 MM ELTA CATAL ANAHTAR	178
0100010607	06X07 ÇATAL İKİ AĞIZ ANAHTAR KISA BOY	41	0130010911	09X11 ÇATAL İKİ AĞIZ ANAHTAR UZUN BOY	42	0150011415	14X15 MM ELTA CATAL ANAHTAR	178
0100010608	06X08 ÇATAL İKİ AĞIZ ANAHTAR KISA BOY	41	0130011011	10X11 ÇATAL İKİ AĞIZ ANAHTAR UZUN BOY	42	0150011617	16X17 MM ELTA CATAL ANAHTAR	178
0100010708	07X08 ÇATAL İKİ AĞIZ ANAHTAR KISA BOY	41	0130011012	10X12 ÇATAL İKİ AĞIZ ANAHTAR UZUN BOY	42	0150011819	18X19 MM ELTA CATAL ANAHTAR	178
0100010709	07X09 ÇATAL İKİ AĞIZ ANAHTAR KISA BOY	41	0130011013	10X13 ÇATAL İKİ AĞIZ ANAHTAR UZUN BOY	42	0150012022	20X22 MM ELTA CATAL ANAHTAR	178
0100010809	08X09 ÇATAL İKİ AĞIZ ANAHTAR KISA BOY	41	0130011014	10X14 ÇATAL İKİ AĞIZ ANAHTAR UZUN BOY	42	0150012123	21X23 MM ELTA CATAL ANAHTAR	178
0100010810	08X10 ÇATAL İKİ AĞIZ ANAHTAR KISA BOY	41	0130011113	11X13 ÇATAL İKİ AĞIZ ANAHTAR UZUN BOY	42	0150012426	24X26 MM ELTA CATAL ANAHTAR	178
0100010910	09X10 ÇATAL İKİ AĞIZ ANAHTAR KISA BOY	41	0130011114	11X14 ÇATAL İKİ AĞIZ ANAHTAR UZUN BOY	42	0150012528	25X28 MM ELTA CATAL ANAHTAR	178
0100010911	09X11 ÇATAL İKİ AĞIZ ANAHTAR KISA BOY	41	0130011213	12X13 ÇATAL İKİ AĞIZ ANAHTAR UZUN BOY	42	0150012732	27X32 MM ELTA CATAL ANAHTAR	178
0100011011	10X11 ÇATAL İKİ AĞIZ ANAHTAR KISA BOY	41	0130011214	12X14 ÇATAL İKİ AĞIZ ANAHTAR UZUN BOY	42	0161002108	8'Lİ ÇATAL İKİ AĞIZ ANAHTAR TK. UZUN BOY (SAE)	43
0100011012	10X12 ÇATAL İKİ AĞIZ ANAHTAR KISA BOY	41	0130011314	13X14 ÇATAL İKİ AĞIZ ANAHTAR UZUN BOY	42	0161002112	12'Lİ ÇATAL İKİ AĞIZ ANAHTAR TK. UZUN BOY (SAE)	43
0100011013	10X13 ÇATAL İKİ AĞIZ ANAHTAR KISA BOY	41	0130011315	13X15 ÇATAL İKİ AĞIZ ANAHTAR UZUN BOY	42	0161010608	1/4x 5/16 ÇATAL İKİ AĞIZ ANAHTAR UZUN (SAE)	43
0100011014	10X14 ÇATAL İKİ AĞIZ ANAHTAR KISA BOY	41	0130011317	13X17 ÇATAL İKİ AĞIZ ANAHTAR UZUN BOY	42	0161010809	5/16x3/8 ÇATAL İKİ AĞIZ ANAHTAR UZUN (SAE)	43
0100011113	11X13 ÇATAL İKİ AĞIZ ANAHTAR KISA BOY	41	0130011415	14X15 ÇATAL İKİ AĞIZ ANAHTAR UZUN BOY	42	0161010810	5/16x11/32 ÇATAL İKİ AĞIZ ANAHTAR UZUN (SAE)	43
0100011114	11X14 ÇATAL İKİ AĞIZ ANAHTAR KISA BOY	41	0130011417	14X17 ÇATAL İKİ AĞIZ ANAHTAR UZUN BOY	42	0161010811	5/16x7/16 ÇATAL İKİ AĞIZ ANAHTAR UZUN (SAE)	43
0100011213	12X13 ÇATAL İKİ AĞIZ ANAHTAR KISA BOY	41	0130011617	16X17 ÇATAL İKİ AĞIZ ANAHTAR UZUN BOY	42	0161010911	3/8x7/16 ÇATAL İKİ AĞIZ ANAHTAR UZUN BOY (SAE)	43
0100011214	12X14 ÇATAL İKİ AĞIZ ANAHTAR KISA BOY	41	0130011618	16X18 ÇATAL İKİ AĞIZ ANAHTAR UZUN BOY	42	0161011112	7/16x1/2 ÇATAL İKİ AĞIZ ANAHTAR UZUN BOY (SAE)	43
0100011314	13X14 ÇATAL İKİ AĞIZ ANAHTAR KISA BOY	41	0130011719	17X19 ÇATAL İKİ AĞIZ ANAHTAR UZUN BOY	42	0161011214	1/2x9/16 ÇATAL İKİ AĞIZ ANAHTAR UZUN BOY (SAE)	43
0100011315	13X15 ÇATAL İKİ AĞIZ ANAHTAR KISA BOY	41	0130011722	17X22 ÇATAL İKİ AĞIZ ANAHTAR UZUN BOY	42	0161011416	9/16x5/8 ÇATAL İKİ AĞIZ ANAHTAR UZUN BOY (SAE)	43
0100011317	13X17 ÇATAL İKİ AĞIZ ANAHTAR KISA BOY	41	0130011724	17X24 ÇATAL İKİ AĞIZ ANAHTAR UZUN BOY	42	0161011417	9/16x11/16 ÇATAL İKİ AĞIZ ANAHTAR UZUN (SAE)	43
0100011415	14X15 ÇATAL İKİ AĞIZ ANAHTAR KISA BOY	41	0130011819	18X19 ÇATAL İKİ AĞIZ ANAHTAR UZUN BOY	42	0161011517	19/32x11/16 ÇATAL İKİ AĞIZ ANAHTAR UZUN (SAE)	43
0100011417	14X17 ÇATAL İKİ AĞIZ ANAHTAR KISA BOY	41	0130011921	19X21 ÇATAL İKİ AĞIZ ANAHTAR UZUN BOY	42	0161011619	5/8x3/4 ÇATAL İKİ AĞIZ ANAHTAR UZUN BOY (SAE)	43
0100011617	16X17 ÇATAL İKİ AĞIZ ANAHTAR KISA BOY	41	0130011922	19X22 ÇATAL İKİ AĞIZ ANAHTAR UZUN BOY	42	0161011920	3/4x25/32 ÇATAL İKİ AĞIZ ANAHTAR UZUN (SAE)	43
0100011719	17X19 ÇATAL İKİ AĞIZ ANAHTAR KISA BOY	41	0130011924	19X24 ÇATAL İKİ AĞIZ ANAHTAR UZUN BOY	42	0161011922	3/4x7/8 ÇATAL İKİ AĞIZ ANAHTAR UZUN BOY (SAE)	43
0100011722	17X22 ÇATAL İKİ AĞIZ ANAHTAR KISA BOY	41	0130012022	20x22 ÇATAL İKİ AĞIZ ANAHTAR UZUN BOY	42	0161012021	25/32x13/16 ÇATAL İKİ AĞIZ ANAHTAR UZUN (SAE)	43
0100011819	18X19 ÇATAL İKİ AĞIZ ANAHTAR KISA BOY	41	0130012123	21X23 ÇATAL İKİ AĞIZ ANAHTAR UZUN BOY	42	0161012122	13/16x7/8 ÇATAL İKİ AĞIZ ANAHTAR UZUN (SAE)	43
0100011820	18x20 ÇATAL İKİ AĞIZ ANAHTAR KISA BOY	41	0130012224	22X24 ÇATAL İKİ AĞIZ ANAHTAR UZUN BOY	42	0161012325	15/16x1 ÇATAL İKİ AĞIZ ANAHTAR UZUN (SAE)	43
0100011822	18X22 ÇATAL İKİ AĞIZ ANAHTAR KISA BOY	41	0130012227	22X27 ÇATAL İKİ AĞIZ ANAHTAR UZUN BOY	42	0161012328	15/16x1 1/8 ÇATAL İKİ AĞIZ ANAHTAR UZUN (SAE)	43
0100011922	19X22 ÇATAL İKİ AĞIZ ANAHTAR KISA BOY	41	0130012426	24X26 ÇATAL İKİ AĞIZ ANAHTAR UZUN BOY	42	0161012628	1 1/16x1 1/8 ÇATAL İKİ AĞIZ ANAHTAR UZUN (SAE)	43
0100011924	19X24 ÇATAL İKİ AĞIZ ANAHTAR KISA BOY	41	0130012427	24X27 ÇATAL İKİ AĞIZ ANAHTAR UZUN BOY .	42	0161012631	1 1/16x1 1/4 ÇATAL İKİ AĞIZ ANAHTAR UZUN (SAE)	43
0100012022	20X22 ÇATAL İKİ AĞIZ ANAHTAR KISA BOY	41	0130012430	24X30 ÇATAL İKİ AĞIZ ANAHTAR UZUN BOY	42	0161012833	1 1/8x1 5/16 ÇATAL İKİ AĞIZ ANAHTAR UZUN (SAE)	43
0100012123	21X23 ÇATAL İKİ AĞIZ ANAHTAR KISA BOY	41	0130012528	25X28 ÇATAL İKİ AĞIZ ANAHTAR UZUN BOY	42	0220011722	17X22 ÇATAL İKİ AĞIZ TAÇLI ANAHTAR	43
0100012224	22X24 ÇATAL İKİ AĞIZ ANAHTAR KISA BOY	41	0130012729	27X29 ÇATAL İKİ AĞIZ ANAHTAR UZUN BOY	42	0250010021	21 MM BİR AĞIZ TAÇLI ANAHTAR	44
0100012226	22X26 ÇATAL İKİ AĞIZ ANAHTAR KISA BOY	41	0130012730	27X30 ÇATAL İKİ AĞIZ ANAHTAR UZUN BOY	42	0250010022	22 MM BİR AĞIZ TAÇLI ANAHTAR	44
0100012227	22X27 ÇATAL İKİ AĞIZ ANAHTAR KISA BOY	41	0130012732	27X32 ÇATAL İKİ AĞIZ ANAHTAR UZUN BOY	42	0250010023	23 MM BİR AĞIZ TAÇLI ANAHTAR	44
0100012426	24X26 ÇATAL İKİ AĞIZ ANAHTAR KISA BOY	41	0130013032	30X32 ÇATAL İKİ AĞIZ ANAHTAR UZUN BOY	42	0250010024	24 MM BİR AĞIZ TAÇLI ANAHTAR	44
0100012427	24X27 ÇATAL İKİ AĞIZ ANAHTAR KISA BOY	41	0130013036	30X36 ÇATAL İKİ AĞIZ ANAHTAR UZUN BOY	42	0250010025	25 MM BİR AĞIZ TAÇLI ANAHTAR	44
0100012430	24X30 ÇATAL İKİ AĞIZ ANAHTAR KISA BOY	41	0130013236	32X36 ÇATAL İKİ AĞIZ ANAHTAR UZUN BOY	42	0250010027	27 MM BİR AĞIZ TAÇLI ANAHTAR	44
0100012528	25X28 ÇATAL İKİ AĞIZ ANAHTAR KISA BOY	41	0130013436	34X36 ÇATAL İKİ AĞIZ ANAHTAR UZUN BOY	42	0250010030	30 MM BİR AĞIZ TAÇLI ANAHTAR	44
0100012730	27X30 ÇATAL İKİ AĞIZ ANAHTAR KISA BOY	41	0130013641	36X41 ÇATAL İKİ AĞIZ ANAHTAR UZUN BOY	42	0250010032	32 MM BİR AĞIZ TAÇLI ANAHTAR	44
0100012732	27X32 ÇATAL İKİ AĞIZ ANAHTAR KISA BOY	41	0130014146	41X46 ÇATAL İKİ AĞIZ ANAHTAR UZUN BOY	42	0250010034	34 MM BİR AĞIZ TAÇLI ANAHTAR	44
0100013032	30X32 ÇATAL İKİ AĞIZ ANAHTAR KISA BOY	41	0130014650	46X50 ÇATAL İKİ AĞIZ ANAHTAR UZUN BOY	42	0250010036	36 MM BİR AĞIZ TAÇLI ANAHTAR	44
0130002108	8'Lİ ÇATAL İKİ AĞIZ ANAHTAR TAKIMI UZUN BOY	42	0132011415	14X15 ÇATAL İKİ AĞIZ ANAHTAR UZUN BOY MASTER	43	0250010038	38 MM BİR AĞIZ TAÇLI ANAHTAR	44
0130002112	12'Lİ ÇATAL İKİ AĞIZ ANAHTAR TAKIMI UZUN BOY	42	0132011819	18X19 ÇATAL İKİ AĞIZ ANAHTAR UZUN BOY MASTER	43	0250010041	41 MM BİR AĞIZ TAÇLI ANAHTAR	44
0130010555	05X5,5 ÇATAL İKİ AĞIZ ANAHTAR UZUN BOY	42	0132012528	25X28 ÇATAL İKİ AĞIZ ANAHTAR UZUN BOY MASTER	43	0250010046	46 MM BİR AĞIZ TAÇLI ANAHTAR	44
0130010607	06X07 ÇATAL İKİ AĞIZ ANAHTAR UZUN BOY	42	0132012732	27X32 ÇATAL İKİ AĞIZ ANAHTAR UZUN BOY MASTER	43	0250010050	50 MM BİR AĞIZ TAÇLI ANAHTAR	44
0130010608	06X08 ÇATAL İKİ AĞIZ ANAHTAR UZUN BOY	42	0150002108	8' Lİ ELTA CATAL ANAHTAR TK.	178	0250010055	55 MM BİR AĞIZ TAÇLI ANAHTAR	44
0130010708	07X08 ÇATAL İKİ AĞIZ ANAHTAR UZUN BOY	42	0150002112	12' Lİ ELTA CATAL ANAHTAR TK.	178	0250010060	60 MM BİR AĞIZ TAÇLI ANAHTAR	44
0130010709	07X09 ÇATAL İKİ AĞIZ ANAHTAR UZUN BOY	42	0150010607	06X07 MM ELTA CATAL ANAHTAR	178	0250010065	65 MM BİR AĞIZ TAÇLI ANAHTAR	44

KOD CODE	ÜRÜN İSMİ PRODUCT NAME	SAYFA NO PAGE NUMBER	KOD CODE	ÜRÜN İSMİ PRODUCT NAME	SAYFA NO PAGE NUMBER	KOD CODE	ÜRÜN İSMİ PRODUCT NAME	SAYFA NO PAGE NUMBER
0250010070	70 MM BİR AĞIZ TAÇLI ANAHTAR	44	0322020017	17 MM KOMBİNE ANAHTAR KISA BOY MASTER	47	0330020050	50 MM KOMBİNE ANAHTAR UZUN BOY	46
0250010075	75 MM BİR AĞIZ TAÇLI ANAHTAR	44	0322020018	18 MM KOMBİNE ANAHTAR KISA BOY MASTER	47	0330020055	5,5MM KOMBİNE ANAHTAR UZUN BOY	46
0255010010	10 MM SÜPER İZOLELİ ÇATAL BİR AĞIZ ANAHTAR	44	0322020019	19 MM KOMBİNE ANAHTAR KISA BOY MASTER	47	0331002108	8'Lİ KOMBİNE ANAHTAR TAKIMI UZUN BOY (SAE)	47
0255010011	11 MM SÜPER İZOLELİ ÇATAL BİR AĞIZ ANAHTAR	44	0322020020	20 MM KOMBİNE ANAHTAR KISA BOY MASTER	47	0331002112	12'Lİ KOMBİNE ANAHTAR TAKIMI UZUN BOY (SAE)	47
0255010012	12 MM SÜPER İZOLELİ ÇATAL BİR AĞIZ ANAHTAR	44	0322020021	21 MM KOMBİNE ANAHTAR KISA BOY MASTER	47	0331002117	17'Lİ KOMBİNE ANAHTAR TAKIMI UZUN BOY (SAE)	47
0255010013	13 MM SÜPER İZOLELİ ÇATAL BİR AĞIZ ANAHTAR	44	0322020022	22 MM KOMBİNE ANAHTAR KISA BOY MASTER	47	0331002120	20'Lİ KOMBİNE ANAHTAR TAKIMI UZUN BOY (SAE)	47
0255010014	14 MM SÜPER İZOLELİ ÇATAL BİR AĞIZ ANAHTAR	44	0322020024	24 MM KOMBİNE ANAHTAR KISA BOY MASTER	47	0331020005	3/16 KOMBİNE ANAHTAR UZUN BOY (SAE)	47
0255010017	17 MM SÜPER İZOLELİ ÇATAL BİR AĞIZ ANAHTAR	44	0322020025	25 MM KOMBİNE ANAHTAR KISA BOY MASTER	47	0331020006	1/4 KOMBİNE ANAHTAR UZUN BOY (SAE)	47
0255010019	19 MM SÜPER İZOLELİ ÇATAL BİR AĞIZ ANAHTAR	44	0322020026	26 MM KOMBİNE ANAHTAR KISA BOY MASTER	47	0331020008	5/16 KOMBİNE ANAHTAR UZUN BOY (SAE)	47
0255010022	22 MM SÜPER İZOLELİ ÇATAL BİR AĞIZ ANAHTAR	44	0322020030	30 MM KOMBİNE ANAHTAR KISA BOY MASTER	47	0331020010	3/8 KOMBİNE ANAHTAR UZUN BOY (SAE)	47
0255010024	24 MM SÜPER İZOLELİ ÇATAL BİR AĞIZ ANAHTAR	44	0325020010	10 MM MONTAJ ANAHTARI	44	0331020011	7/16 KOMBİNE ANAHTAR UZUN BOY (SAE)	47
0320002108	8'Lİ KOMBİNE ANAHTAR TAKIMI KISA BOY	45	0325020013	13 MM MONTAJ ANAHTARI	44	0331020013	1/2 KOMBİNE ANAHTAR UZUN BOY (SAE)	47
0320002112	12'Lİ KOMBİNE ANAHTAR TAKIMI KISA BOY	45	0325020017	17 MM MONTAJ ANAHTARI	44	0331020014	9/16 KOMBİNE ANAHTAR UZUN BOY (SAE)	47
0320002117	17'Lİ KOMBİNE ANAHTAR TAKIMI KISA BOY	45	0325020019	19 MM MONTAJ ANAHTARI	44	0331020015	19/32 KOMBİNE ANAHTAR UZUN BOY (SAE)	47
0320002121	21'Lİ KOMBİNE ANAHTAR TAKIMI KISA BOY	45	0325020020	20 MM MONTAJ ANAHTARI	44	0331020016	5/8 KOMBİNE ANAHTAR UZUN BOY (SAE)	47
0320020005	05 MM KOMBİNE ANAHTAR KISA BOY	45	0325020021	21 MM MONTAJ ANAHTARI	44	0331020017	11/16 KOMBİNE ANAHTAR UZUN BOY (SAE)	47
0320020006	06 MM KOMBİNE ANAHTAR KISA BOY	45	0325020022	22 MM MONTAJ ANAHTARI	44	0331020019	3/4 KOMBİNE ANAHTAR UZUN BOY (SAE)	47
0320020007	07 MM KOMBİNE ANAHTAR KISA BOY	45	0330002108	8'Lİ KOMBİNE ANAHTAR TAKIMI UZUN BOY	46	0331020020	25/32 KOMBİNE ANAHTAR UZUN BOY (SAE)	47
0320020008	08 MM KOMBİNE ANAHTAR KISA BOY	45	0330002112	12'Lİ KOMBİNE ANAHTAR TAKIMI UZUN BOY	46	0331020021	13/16 KOMBİNE ANAHTAR UZUN BOY (SAE)	47
0320020009	09 MM KOMBİNE ANAHTAR KISA BOY	45	0330002117	17'Lİ KOMBİNE ANAHTAR TAKIMI UZUN BOY	46	0331020022	7/8 KOMBİNE ANAHTAR UZUN BOY (SAE)	47
0320020010	10 MM KOMBİNE ANAHTAR KISA BOY	45	0330002121	21'Lİ KOMBİNE ANAHTAR TAKIMI UZUN BOY	46	0331020024	15/16 KOMBİNE ANAHTAR UZUN BOY (SAE)	47
0320020011	11 MM KOMBİNE ANAHTAR KISA BOY	45	0330020005	05 MM KOMBİNE ANAHTAR UZUN BOY	46	0331020025	1" KOMBİNE ANAHTAR UZUN BOY (SAE)	47
0320020012	12 MM KOMBİNE ANAHTAR KISA BOY	45	0330020006	06 MM KOMBİNE ANAHTAR UZUN BOY	46	0331020027	1 1/16 KOMBİNE ANAHTAR UZUN BOY (SAE)	47
0320020013	13 MM KOMBİNE ANAHTAR KISA BOY	45	0330020007	07 MM KOMBİNE ANAHTAR UZUN BOY	46	0331020028	1 1/8 KOMBİNE ANAHTAR UZUN BOY (SAE)	47
0320020014	14 MM KOMBİNE ANAHTAR KISA BOY	45	0330020008	08 MM KOMBİNE ANAHTAR UZUN BOY	46	0331020030	1 3/16 KOMBİNE ANAHTAR UZUN BOY (SAE)	47
0320020015	15 MM KOMBİNE ANAHTAR KISA BOY	45	0330020009	09 MM KOMBİNE ANAHTAR UZUN BOY	46	0331020032	1 1/4 KOMBİNE ANAHTAR UZUN BOY (SAE)	47
0320020016	16 MM KOMBİNE ANAHTAR KISA BOY	45	0330020010	10 MM KOMBİNE ANAHTAR UZUN BOY	46	0331020033	1 5/16 KOMBİNE ANAHTAR UZUN BOY (SAE)	47
0320020017	17 MM KOMBİNE ANAHTAR KISA BOY	45	0330020011	11 MM KOMBİNE ANAHTAR UZUN BOY	46	0331020035	1 3/8 KOMBİNE ANAHTAR UZUN BOY (SAE)	47
0320020018	18 MM KOMBİNE ANAHTAR KISA BOY	45	0330020012	12 MM KOMBİNE ANAHTAR UZUN BOY	46	0331020036	1 7/16 KOMBİNE ANAHTAR UZUN BOY (SAE)	47
0320020019	19 MM KOMBİNE ANAHTAR KISA BOY	45	0330020013	13 MM KOMBİNE ANAHTAR UZUN BOY	46	0331020038	1 1/2 KOMBİNE ANAHTAR UZUN BOY (SAE)	47
0320020020	20 MM KOMBİNE ANAHTAR KISA BOY	45	0330020014	14 MM KOMBİNE ANAHTAR UZUN BOY	46	0331020041	1 5/8 KOMBİNE ANAHTAR UZUN BOY (SAE)	47
0320020021	21 MM KOMBİNE ANAHTAR KISA BOY	45	0330020015	15 MM KOMBİNE ANAHTAR UZUN BOY	46	0331020046	1 13/16 KOMBİNE ANAHTAR UZUN BOY (SAE)	47
0320020022	22 MM KOMBİNE ANAHTAR KISA BOY	45	0330020016	16 MM KOMBİNE ANAHTAR UZUN BOY	46	0331020050	2" KOMBİNE ANAHTAR UZUN BOY (SAE)	47
0320020023	23 MM KOMBİNE ANAHTAR KISA BOY	45	0330020017	17 MM KOMBİNE ANAHTAR UZUN BOY	46	0335020010	10x13x17x19 ÇOKLU YILDIZ CİRCİR ANAHTAR	48
0320020024	24 MM KOMBİNE ANAHTAR KISA BOY	45	0330020018	18 MM KOMBİNE ANAHTAR UZUN BOY	46	0340002110	10'LU CİRCİR KOMBİNE ANAHTAR TAKIMI	48
0320020025	25 MM KOMBİNE ANAHTAR KISA BOY	45	0330020019	19 MM KOMBİNE ANAHTAR UZUN BOY	46	0340002115	15'Lİ CİRCİR KOMBİNE ANAHTAR TK.	48
0320020026	26 MM KOMBİNE ANAHTAR KISA BOY	45	0330020020	20 MM KOMBİNE ANAHTAR UZUN BOY	46	0340020008	08 MM CİRCİR KOMBİNE ANAHTAR	48
0320020027	27 MM KOMBİNE ANAHTAR KISA BOY	45	0330020021	21 MM KOMBİNE ANAHTAR UZUN BOY	46	0340020009	09 MM CİRCİR KOMBİNE ANAHTAR	48
0320020028	28 MM KOMBİNE ANAHTAR KISA BOY	45	0330020022	22 MM KOMBİNE ANAHTAR UZUN BOY	46	0340020010	10 MM CİRCİR KOMBİNE ANAHTAR	48
0320020029	29 MM KOMBİNE ANAHTAR KISA BOY	45	0330020023	23 MM KOMBİNE ANAHTAR UZUN BOY	46	0340020011	11 MM CİRCİR KOMBİNE ANAHTAR	48
0320020030	30 MM KOMBİNE ANAHTAR KISA BOY	45	0330020024	24 MM KOMBİNE ANAHTAR UZUN BOY	46	0340020012	12 MM CİRCİR KOMBİNE ANAHTAR	48
0320020032	32 MM KOMBİNE ANAHTAR KISA BOY	45	0330020025	25 MM KOMBİNE ANAHTAR UZUN BOY	46	0340020013	13 MM CİRCİR KOMBİNE ANAHTAR	48
0320020034	34 MM KOMBİNE ANAHTAR KISA BOY	45	0330020026	26 MM KOMBİNE ANAHTAR UZUN BOY	46	0340020014	14 MM CİRCİR KOMBİNE ANAHTAR	48
0320020055	05,5 MM KOMBİNE ANAHTAR KISA BOY	45	0330020027	27 MM KOMBİNE ANAHTAR UZUN BOY	46	0340020015	15 MM CİRCİR KOMBİNE ANAHTAR	48
0322020006	06 MM KOMBİNE ANAHTAR KISA BOY MASTER	47	0330020028	28 MM KOMBİNE ANAHTAR UZUN BOY	46	0340020016	16 MM CİRCİR KOMBİNE ANAHTAR	48
0322020007	07 MM KOMBİNE ANAHTAR KISA BOY MASTER	47	0330020029	29 MM KOMBİNE ANAHTAR UZUN BOY	46	0340020017	17 MM CİRCİR KOMBİNE ANAHTAR	48
0322020008	08 MM KOMBİNE ANAHTAR KISA BOY MASTER	47	0330020030	30 MM KOMBİNE ANAHTAR UZUN BOY	46	0340020018	18 MM CİRCİR KOMBİNE ANAHTAR	48
0322020009	09 MM KOMBİNE ANAHTAR KISA BOY MASTER	47	0330020032	32 MM KOMBİNE ANAHTAR UZUN BOY	46	0340020019	19 MM CİRCİR KOMBİNE ANAHTAR	48
0322020011	11 MM KOMBİNE ANAHTAR KISA BOY MASTER	47	0330020034	34 MM KOMBİNE ANAHTAR UZUN BOY	46	0340020021	21 MM CİRCİR KOMBİNE ANAHTAR	48
0322020012	12 MM KOMBİNE ANAHTAR KISA BOY MASTER	47	0330020036	36 MM KOMBİNE ANAHTAR UZUN BOY	46	0340020022	22 MM CİRCİR KOMBİNE ANAHTAR	48
0322020014	14 MM KOMBİNE ANAHTAR KISA BOY MASTER	47	0330020038	38 MM KOMBİNE ANAHTAR UZUN BOY	46	0340020024	24 MM CİRCİR KOMBİNE ANAHTAR	48
0322020015	15 MM KOMBİNE ANAHTAR KISA BOY MASTER	47	0330020041	41 MM KOMBİNE ANAHTAR UZUN BOY	46	0345002112	12'Lİ MAFSALLI CİRCİR KOMBİNE ANAH. TK.	49
0322020016	16 MM KOMBİNE ANAHTAR KISA BOY MASTER	47	0330020046	46 MM KOMBİNE ANAHTAR UZUN BOY	46	0345020008	08 MM MAFSALLI CİRCİR KOMBİNE ANAH.	49

KOD CODE	ÜRÜN İSMİ PRODUCT NAME	SAYFA NO PAGE NUMBER	KOD CODE	ÜRÜN İSMİ PRODUCT NAME	SAYFA NO PAGE NUMBER	KOD CODE	ÜRÜN İSMİ PRODUCT NAME	SAYFA NO PAGE NUMBER
034502009	09 MM MAFSALLI CIRCIR KOMBİNE ANAH.	49	0370002117	17'Lİ BOYUNLU KOMBİNE ANAHTAR TAKIMI	50	0430031011	10X11 YILDIZ İKİ AĞIZ ANAHTAR	52
0345020010	10 MM MAFSALLI CIRCIR KOMBİNE ANAH.	49	0370002121	21 Lİ BOYUNLU KOMBİNE ANAHTAR TAKIMI	50	0430031012	10X12 YILDIZ İKİ AĞIZ ANAHTAR	52
0345020011	11 MM MAFSALLI CIRCIR KOMBİNE ANAH.	49	0370020006	06 MM BOYUNLU KOMBİNE ANAHTAR	50	0430031013	10X13 YILDIZ İKİ AĞIZ ANAHTAR	52
0345020012	12 MM MAFSALLI CIRCIR KOMBİNE ANAH.	49	0370020007	07 MM BOYUNLU KOMBİNE ANAHTAR	50	0430031014	10X14 YILDIZ İKİ AĞIZ ANAHTAR	52
0345020013	13 MM MAFSALLI CIRCIR KOMBİNE ANAH.	49	0370020008	08 MM BOYUNLU KOMBİNE ANAHTAR	50	0430031113	11X13 YILDIZ İKİ AĞIZ ANAHTAR	52
0345020014	14 MM MAFSALLI CIRCIR KOMBİNE ANAH.	49	0370020009	09 MM BOYUNLU KOMBİNE ANAHTAR	50	0430031213	12X13 YILDIZ İKİ AĞIZ ANAHTAR	52
0345020015	15 MM MAFSALLI CIRCIR KOMBİNE ANAH.	49	0370020010	10 MM BOYUNLU KOMBİNE ANAHTAR	50	0430031214	12X14 YILDIZ İKİ AĞIZ ANAHTAR	52
0345020016	16 MM MAFSALLI CIRCIR KOMBİNE ANAH.	49	0370020011	11 MM BOYUNLU KOMBİNE ANAHTAR	50	0430031315	13X15 YILDIZ İKİ AĞIZ ANAHTAR	52
0345020017	17 MM MAFSALLI CIRCIR KOMBİNE ANAH.	49	0370020012	12 MM BOYUNLU KOMBİNE ANAHTAR	50	0430031317	13X17 YILDIZ İKİ AĞIZ ANAHTAR	52
0345020018	18 MM MAFSALLI CIRCIR KOMBİNE ANAH.	49	0370020013	13 MM BOYUNLU KOMBİNE ANAHTAR	50	0430031415	14X15 YILDIZ İKİ AĞIZ ANAHTAR	52
0345020019	19 MM MAFSALLI CIRCIR KOMBİNE ANAH.	49	0370020014	14 MM BOYUNLU KOMBİNE ANAHTAR	50	0430031417	14X17 YILDIZ İKİ AĞIZ ANAHTAR	52
0350002108	8' Lİ ELTA KOMBİNE ANAHTAR TK.	179	0370020015	15 MM BOYUNLU KOMBİNE ANAHTAR	50	0430031617	16X17 YILDIZ İKİ AĞIZ ANAHTAR	52
0350002112	12'Lİ ELTA KOMBİNE ANAHTAR TK.	179	0370020016	16 MM BOYUNLU KOMBİNE ANAHTAR	50	0430031618	16x18 YILDIZ İKİ AĞIZ ANAHTAR	52
0350002117	17' Lİ ELTA KOMBİNE ANAHTAR TK.	179	0370020017	17 MM BOYUNLU KOMBİNE ANAHTAR	50	0430031719	17X19 YILDIZ İKİ AĞIZ ANAHTAR	52
0350002121	21' Lİ ELTA KOMBİNE ANAHTAR TK.	179	0370020018	18 MM BOYUNLU KOMBİNE ANAHTAR	50	0430031819	18X19 YILDIZ İKİ AĞIZ ANAHTAR	52
0350020006	06 MM ELTA KOMBİNE ANAHTAR	179	0370020019	19 MM BOYUNLU KOMBİNE ANAHTAR	50	0430031922	19X22 YILDIZ İKİ AĞIZ ANAHTAR	52
0350020007	07 MM ELTA KOMBİNE ANAHTAR	179	0370020020	20 MM BOYUNLU KOMBİNE ANAHTAR	50	0430031924	19X24 YILDIZ İKİ AĞIZ ANAHTAR	52
0350020008	08 MM ELTA KOMBİNE ANAHTAR	179	0370020021	21 MM BOYUNLU KOMBİNE ANAHTAR	50	0430032022	20X22 YILDIZ İKİ AĞIZ ANAHTAR	52
0350020009	09 MM ELTA KOMBİNE ANAHTAR	179	0370020022	22 MM BOYUNLU KOMBİNE ANAHTAR	50	0430032123	21X23 YILDIZ İKİ AĞIZ ANAHTAR	52
0350020010	10 MM ELTA KOMBİNE ANAHTAR	179	0370020023	23 MM BOYUNLU KOMBİNE ANAHTAR	50	0430032224	22X24 YILDIZ İKİ AĞIZ ANAHTAR	52
0350020011	11 MM ELTA KOMBİNE ANAHTAR	179	0370020024	24 MM BOYUNLU KOMBİNE ANAHTAR	50	0430032227	22X27 YILDIZ İKİ AĞIZ ANAHTAR	52
0350020012	12 MM ELTA KOMBİNE ANAHTAR	179	0370020025	25 MM BOYUNLU KOMBİNE ANAHTAR	50	0430032426	24x26 YILDIZ İKİ AĞIZ ANAHTAR	52
0350020013	13 MM ELTA KOMBİNE ANAHTAR	179	0370020026	26 MM BOYUNLU KOMBİNE ANAHTAR	50	0430032427	24X27 YILDIZ İKİ AĞIZ ANAHTAR	52
0350020014	14 MM ELTA KOMBİNE ANAHTAR	179	0370020027	27 MM BOYUNLU KOMBİNE ANAHTAR	50	0430032430	24X30 YILDIZ İKİ AĞIZ ANAHTAR	52
0350020015	15 MM ELTA KOMBİNE ANAHTAR	179	0370020028	28 MM BOYUNLU KOMBİNE ANAHTAR	50	0430032528	25X28 YILDIZ İKİ AĞIZ ANAHTAR	52
0350020016	16 MM ELTA KOMBİNE ANAHTAR	179	0370020029	29 MM BOYUNLU KOMBİNE ANAHTAR	50	0430032729	27X29 YILDIZ İKİ AĞIZ ANAHTAR	52
0350020017	17 MM ELTA KOMBİNE ANAHTAR	179	0370020030	30 MM BOYUNLU KOMBİNE ANAHTAR	50	0430032730	27X30 YILDIZ İKİ AĞIZ ANAHTAR	52
0350020018	18 MM ELTA KOMBİNE ANAHTAR	179	0370020032	32 MM BOYUNLU KOMBİNE ANAHTAR	50	0430032732	27X32 YILDIZ İKİ AĞIZ ANAHTAR	52
0350020019	19 MM ELTA KOMBİNE ANAHTAR	179	0370020036	36 MM BOYUNLU KOMBİNE ANAHTAR	50	0430033032	30X32 YILDIZ İKİ AĞIZ ANAHTAR	52
0350020020	20 MM ELTA KOMBİNE ANAHTAR	179	0375050020	Ø8 - 28 KABLO SIYIRICI	151	0430033034	30X34 YILDIZ İKİ AĞIZ ANAHTAR	52
0350020021	21 MM ELTA KOMBİNE ANAHTAR	179	0375150012	KOAKSİYEL KABLO SIYIRICI (DIŞ 1-İÇ 2)	151	0430033036	30X36 YILDIZ İKİ AĞIZ ANAHTAR	52
0350020022	22 MM ELTA KOMBİNE ANAHTAR	179	0375250625	KABLO SIYIRICI (TEKLİ 6/300 - ÇOKLU 1,5/25)	151	0430033236	32X36 YILDIZ İKİ AĞIZ ANAHTAR	52
0350020024	24 MM ELTA KOMBİNE ANAHTAR	179	0375350054	0,5 - 4 MM MEKANİK KABLO SIYIRICI	151	0430033436	34X36 YILDIZ İKİ AĞIZ ANAHTAR	52
0350020027	27 MM ELTA KOMBİNE ANAHTAR	179	0375550625	KABLO SIYIRICI YEDEK BİÇAĞI	197	0430033641	36X41 YILDIZ İKİ AĞIZ ANAHTAR	52
0350020030	30 MM ELTA KOMBİNE ANAHTAR	179	0380002108	8'Lİ TORX KOMBİNE ANAHTAR TAKIMI	51	0430034146	41X46 YILDIZ İKİ AĞIZ ANAHTAR	52
0350020032	32 MM ELTA KOMBİNE ANAHTAR	179	0380002112	12'Lİ TORX KOMBİNE ANAHTAR TAKIMI	51	0430034650	46X50 YILDIZ İKİ AĞIZ ANAHTAR	52
0360020008	08 MM EXTRA UZUN KOMBİNE ANAHTAR	49	0380020008	08 MM TORX KOMBİNE ANAHTAR	51	0431002108	8'Lİ YILDIZ İKİ AĞIZ ANAHTAR TAKIMI (SAE)	53
0360020009	09 MM EXTRA UZUN KOMBİNE ANAHTAR	49	0380020009	09 MM TORX KOMBİNE ANAHTAR	51	0431002112	12'Lİ YILDIZ İKİ AĞIZ ANAHTAR TAKIMI (SAE)	53
0360020010	10 MM EXTRA UZUN KOMBİNE ANAHTAR	49	0380020010	10 MM TORX KOMBİNE ANAHTAR	51	0431030608	1/4x 5/16 YILDIZ İKİ AĞIZ ANAHTAR (SAE)	53
0360020011	11 MM EXTRA UZUN KOMBİNE ANAHTAR	49	0380020011	11 MM TORX KOMBİNE ANAHTAR	51	0431030809	5/16x 3/8 YILDIZ İKİ AĞIZ ANAHTAR (SAE)	53
0360020012	12 MM EXTRA UZUN KOMBİNE ANAHTAR	49	0380020012	12 MM TORX KOMBİNE ANAHTAR	51	0431030811	5/16 x 7/16 YILDIZ İKİ AĞIZ ANAHTAR (SAE)	53
0360020014	14 MM EXTRA UZUN KOMBİNE ANAHTAR	49	0380020013	13 MM TORX KOMBİNE ANAHTAR	51	0431030911	3/8x 7/16 YILDIZ İKİ AĞIZ ANAHTAR (SAE)	53
0360020015	15 MM EXTRA UZUN KOMBİNE ANAHTAR	49	0380020014	14 MM TORX KOMBİNE ANAHTAR	51	0431031112	7/16x1/2 YILDIZ İKİ AĞIZ ANAHTAR (SAE)	53
0360020016	16 MM EXTRA UZUN KOMBİNE ANAHTAR	49	0380020015	15 MM TORX KOMBİNE ANAHTAR	51	0431031214	1/2x9/16 YILDIZ İKİ AĞIZ ANAHTAR (SAE)	53
0360020018	18 MM EXTRA UZUN KOMBİNE ANAHTAR	49	0380020017	17 MM TORX KOMBİNE ANAHTAR	51	0431031217	1/2x11/16 YILDIZ İKİ AĞIZ ANAHTAR (SAE)	53
0360020020	20 MM EXTRA UZUN KOMBİNE ANAHTAR	49	0380020018	18 MM TORX KOMBİNE ANAHTAR	51	0431031415	9/16x19/32 YILDIZ İKİ AĞIZ ANAHTAR (SAE)	53
0360020030	30 MM EXTRA UZUN KOMBİNE ANAHTAR	49	0380020019	19 MM TORX KOMBİNE ANAHTAR	51	0431031416	9/16x5/8 YILDIZ İKİ AĞIZ ANAHTAR (SAE)	53
0360020032	32 MM EXTRA UZUN KOMBİNE ANAHTAR	49	0380020022	22 MM TORX KOMBİNE ANAHTAR	51	0431031417	9/16x11/16 YILDIZ İKİ AĞIZ ANAHTAR (SAE)	53
0360020034	34 MM EXTRA UZUN KOMBİNE ANAHTAR	49	0430002108	8'Lİ YILDIZ İKİ AĞIZ ANAHTAR TAKIMI	52	0431031517	19/32x11/16 YILDIZ İKİ AĞIZ ANAHTAR (SAE)	53
0360020041	41 MM EXTRA UZUN KOMBİNE ANAHTAR	49	0430002112	12'Lİ YILDIZ İKİ AĞIZ ANAHTAR TAKIMI	52	0431031617	5/8x11/16 YILDIZ İKİ AĞIZ ANAHTAR (SAE)	53
0360020046	46 MM EXTRA UZUN KOMBİNE ANAHTAR	49	0430030607	06X07 YILDIZ İKİ AĞIZ ANAHTAR	52	0431031619	5/8x3/4 YILDIZ İKİ AĞIZ ANAHTAR (SAE)	53
0370002108	8'Lİ BOYUNLU KOMBİNE ANAHTAR TAKIMI	50	0430030809	08X09 YILDIZ İKİ AĞIZ ANAHTAR	52	0431031920	3/4x25/32 YILDIZ İKİ AĞIZ ANAHTAR (SAE)	53
0370002112	12'Lİ BOYUNLU KOMBİNE ANAHTAR TAKIMI	50	0430030810	08X10 YILDIZ İKİ AĞIZ ANAHTAR	52	0431031922	3/4x7/8 YILDIZ İKİ AĞIZ ANAHTAR (SAE)	53

KOD CODE	ÜRÜN İSMİ PRODUCT NAME	SAYFA NO PAGE NUMBER	KOD CODE	ÜRÜN İSMİ PRODUCT NAME	SAYFA NO PAGE NUMBER	KOD CODE	ÜRÜN İSMİ PRODUCT NAME	SAYFA NO PAGE NUMBER
0431032021	25/32x13/16 YILDIZ İKİ AĞIZ ANAHTAR (SAE)	53	0450030607	06X07 ELTA YILDIZ ANAHTAR	180	0550050090	90 MM BORU UZATMALI YILDIZ ANAHTAR	57
0431032122	13/16x7/8 YILDIZ İKİ AĞIZ ANAHTAR (SAE)	53	0450030809	08X09 ELTA YILDIZ ANAHTAR	180	0550050095	95 MM BORU UZATMALI YILDIZ ANAHTAR	57
0431032223	7/8x15/16 YILDIZ İKİ AĞIZ ANAHTAR (SAE)	53	0450031011	10X11 ELTA YILDIZ ANAHTAR	180	0550050100	100 MM BORU UZATMALI YILDIZ ANAHTAR	57
0431032325	15/16x1 YILDIZ İKİ AĞIZ ANAHTAR (SAE)	53	0450031213	12X13 ELTA YILDIZ ANAHTAR	180	0551050001	22-30 MM DÖNDÜRME KOLU BORUSU	57
0431032328	15/16x1 1/8 YILDIZ İKİ AĞIZ ANAHTAR (SAE)	53	0450031415	14X15 ELTA YILDIZ ANAHTAR	180	0551050002	32-41 MM DÖNDÜRME KOLU BORUSU	57
0431032528	1x1 1/8 YILDIZ İKİ AĞIZ ANAHTAR (SAE)	53	0450031617	16X17 ELTA YILDIZ ANAHTAR	180	0551050003	46-55 MM DÖNDÜRME KOLU BORUSU	57
0431032631	1 1/16x1 1/4 YILDIZ İKİ AĞIZ ANAHTAR (SAE)	53	0450031819	18X19 ELTA YILDIZ ANAHTAR	180	0551050004	60-100 MM DÖNDÜRME KOLU BORUSU	57
0431032833	1 1/8x1 5/16 YILDIZ İKİ AĞIZ ANAHTAR (SAE)	53	0450032022	20X22 ELTA YILDIZ ANAHTAR	180	0588050040	40 CM SU TERAZİSİ (ALÜMİNYUM)	152
0431033033	1 3/16x1 5/16 YILDIZ İKİ AĞIZ ANAHTAR (SAE)	53	0450032123	21X23 ELTA YILDIZ ANAHTAR	180	0588050050	50 CM SU TERAZİSİ (ALÜMİNYUM)	152
0431033036	1 3/16 x1 3/8 YILDIZ İKİ AĞIZ ANAHTAR (SAE)	53	0450032426	24X26 ELTA YILDIZ ANAHTAR	180	0588050060	60 CM SU TERAZİSİ (ALÜMİNYUM)	152
0431033236	1 1/4x1 7/16 YILDIZ İKİ AĞIZ ANAHTAR (SAE)	53	0450032528	25X28 ELTA YILDIZ ANAHTAR	180	0588050070	70 CM SU TERAZİSİ (ALÜMİNYUM)	152
0431033641	1 7/16x1 5/8 YILDIZ İKİ AĞIZ ANAHTAR (SAE)	53	0450032732	27X32 ELTA YILDIZ ANAHTAR	180	0588050080	80 CM SU TERAZİSİ (ALÜMİNYUM)	152
0431034146	1 11/16x1 7/8 YILDIZ İKİ AĞIZ ANAHTAR (SAE)	53	0530040810	08x10 YARIM AY ANAHTAR YILDIZ İKİ AĞIZ	55	0588050100	100 CM SU TERAZİSİ (ALÜMİNYUM)	152
0431034650	1 13/16x2" YILDIZ İKİ AĞIZ ANAHTAR (SAE)	53	0530041011	10X11 YARIM AY ANAHTAR YILDIZ İKİ AĞIZ	55	0588050120	120 CM SU TERAZİSİ (ALÜMİNYUM)	152
0432030607	06X07 YILDIZ İKİ AĞIZ ANAHTAR MASTER	53	0530041012	10x12 YARIM AY ANAHTAR YILDIZ İKİ AĞIZ	55	0588050150	150 CM SU TERAZİSİ (ALÜMİNYUM)	152
0432031819	18X19 YILDIZ İKİ AĞIZ ANAHTAR MASTER	53	0530041113	11X13 YARIM AY ANAHTAR YILDIZ İKİ AĞIZ	55	0588050200	200 CM SU TERAZİSİ (ALÜMİNYUM)	152
0432032528	25X28 YILDIZ İKİ AĞIZ ANAHTAR MASTER	53	0530041315	13X15 YARIM AY ANAHTAR YILDIZ İKİ AĞIZ	55	0588150003	3 M PLASTİK STOPLU ŞERİT METRE	151
0432032732	27X32 YILDIZ İKİ AĞIZ ANAHTAR MASTER	53	0530041317	13X17 YARIM AY ANAHTAR YILDIZ İKİ AĞIZ	55	0588150005	5 M PLASTİK STOPLU ŞERİT METRE	151
0435030010	10 MM SÜPER İZOLELİ BİR AĞIZ YILDIZ ANAHTAR	55	0530041417	14X17 YARIM AY ANAHTAR YILDIZ İKİ AĞIZ	55	0588150013	3 M CROM STOPLU ŞERİT METRE	151
0435030011	11 MM SÜPER İZOLELİ BİR AĞIZ YILDIZ ANAHTAR	55	0530041517	15X17 YARIM AY ANAHTAR YILDIZ İKİ AĞIZ	55	0588150015	5 M CROM STOPLU ŞERİT METRE	151
0435030012	12 MM SÜPER İZOLELİ BİR AĞIZ YILDIZ ANAHTAR	55	0530041922	19X22 YARIM AY ANAHTAR YILDIZ İKİ AĞIZ	55	0588650020	20 MT. SAPLI ARAZİ ŞERİT METRE	152
0435030013	13 MM SÜPER İZOLELİ BİR AĞIZ YILDIZ ANAHTAR	55	0531040809	5/16 X3/8 YARIM AY ANH. YILDIZ İKİ AĞIZ (SAE)	55	0588650030	30 MT. SAPLI ARAZİ ŞERİT METRE	152
0435030014	14 MM SÜPER İZOLELİ BİR AĞIZ YILDIZ ANAHTAR	55	0531040911	3/8 X7/16 YARIM AY ANH. YILDIZ İKİ AĞIZ (SAE)	55	0588650050	50 MT. SAPLI ARAZİ ŞERİT METRE	152
0435030017	17 MM SÜPER İZOLELİ BİR AĞIZ YILDIZ ANAHTAR	55	0531041112	7/16x1/2 YARIM AY ANAHTAR YILDIZ İKİ AĞIZ (SAE)	55	0588750150	150 MM KUMPAS (SÜRGÜLÜ STOPLU)	152
0435030019	19 MM SÜPER İZOLELİ BİR AĞIZ YILDIZ ANAHTAR	55	0531041214	1/2x9/16 YARIM AY ANAHTAR YILDIZ İKİ AĞIZ (SAE)	55	0589050830	30 CM LİK TESTERE KOLU	152
0435030022	22 MM SÜPER İZOLELİ BİR AĞIZ YILDIZ ANAHTAR	55	0531041416	9/16x5/8 YARIM AY ANAHTAR YILDIZ İKİ AĞIZ (SAE)	55	0589550150	150 MM KİL TESTERE (AĞAÇ SAPLI)	152
0435030024	24 MM SÜPER İZOLELİ BİR AĞIZ YILDIZ ANAHTAR	55	0531041417	9/16x11/16 YARIM AY ANH. YILDIZ İKİ AĞIZ (SAE)	55	0589850283	13x0.65x18 HSS TESTERE LAMASI	198
0440002108	08"Lİ DÜZ YILDIZ ANAHTAR TK	54	0531041922	3/4x7/8 YARIM AY ANAHTAR YILDIZ İKİ AĞIZ (SAE)	55	0589950283	13x0.65x24 BİMETAL TESTERE	198
0440002112	12"Lİ DÜZ YILDIZ ANAHTAR TK.	54	0540010810	08x10 MM REKOR ANAHTAR	55	0590150020	0.05-1 MM SENTİL	153
0440030607	06X07 DÜZ YILDIZ ANAHTAR	54	0540011011	10x11 MM REKOR ANAHTAR	55	0590250020	2-35/1000" SAE SENTİL	153
0440030809	08X09 DÜZ YILDIZ ANAHTAR	54	0540011012	10x12 MM REKOR ANAHTAR	55	0600010206	6" KURBAGACIK YED.PAR.(SOMUN)	196
0440030810	08X10 DÜZ YILDIZ ANAHTAR	54	0540011113	11x13 MM REKOR ANAHTAR	55	0600010208	8" KURBAGACIK YED.PAR.(SOMUN)	196
0440031011	10X11 DÜZ YILDIZ ANAHTAR	54	0540011214	12x14 MM REKOR ANAHTAR	55	0600010210	10" KURBAGACIK YED.PAR.(SOMUN)	196
0440031013	10X13 DÜZ YILDIZ ANAHTAR	54	0540011719	17x19 MM REKOR ANAHTAR	55	0600010212	12" KURBAGACIK YED.PAR.(SOMUN)	196
0440031213	12X13 DÜZ YILDIZ ANAHTAR	54	0540011922	19x22 MM REKOR ANAHTAR	55	0600010215	15" KURBAGACIK YED.PAR.(SOMUN)	196
0440031315	13X15 DÜZ YILDIZ ANAHTAR	54	0550050022	22 MM BORU UZATMALI YILDIZ ANAHTAR	57	0600010306	6" KURBAGACIK YED.PAR.(VİDA)	196
0440031317	13X17 DÜZ YILDIZ ANAHTAR	54	0550050024	24 MM BORU UZATMALI YILDIZ ANAHTAR	57	0600010308	8" KURBAGACIK YED.PAR.(VİDA)	196
0440031415	14X15 DÜZ YILDIZ ANAHTAR	54	0550050027	27 MM BORU UZATMALI YILDIZ ANAHTAR	57	0600010310	10" KURBAGACIK YED.PAR.(VİDA)	196
0440031617	16X17 DÜZ YILDIZ ANAHTAR	54	0550050030	30 MM BORU UZATMALI YILDIZ ANAHTAR	57	0600010312	12" KURBAGACIK YED.PAR.(VİDA)	196
0440031618	16X18 DÜZ YILDIZ ANAHTAR	54	0550050032	32 MM BORU UZATMALI YILDIZ ANAHTAR	57	0600010315	15" KURBAGACIK YED.PAR.(VİDA)	196
0440031719	17X19 DÜZ YILDIZ ANAHTAR	54	0550050034	34 MM BORU UZATMALI YILDIZ ANAHTAR	57	0600010406	6" KURBAGACIK YED.PAR.(YAY)	196
0440031819	18X19 DÜZ YILDIZ ANAHTAR	54	0550050036	36 MM BORU UZATMALI YILDIZ ANAHTAR	57	0600010408	8" KURBAGACIK YED.PAR.(YAY)	196
0440032022	20X22 DÜZ YILDIZ ANAHTAR	54	0550050038	38 MM BORU UZATMALI YILDIZ ANAHTAR	57	0600010410	10" KURBAGACIK YED.PAR.(YAY)	196
0440032123	21X23 DÜZ YILDIZ ANAHTAR	54	0550050041	41 MM BORU UZATMALI YILDIZ ANAHTAR	57	0600010412	12" KURBAGACIK YED.PAR.(YAY)	196
0440032224	22X24 DÜZ YILDIZ ANAHTAR	54	0550050046	46 MM BORU UZATMALI YILDIZ ANAHTAR	57	0600010415	15" KURBAGACIK YED.PAR.(YAY)	196
0440032426	24X26 DÜZ YILDIZ ANAHTAR	54	0550050050	50 MM BORU UZATMALI YILDIZ ANAHTAR	57	0600011006	6" KURBAĞACIK ANAHTAR PVC	57
0440032427	24X27 DÜZ YILDIZ ANAHTAR	54	0550050055	55 MM BORU UZATMALI YILDIZ ANAHTAR	57	0600011008	8" KURBAĞACIK ANAHTAR PVC	57
0440032528	25X28 DÜZ YILDIZ ANAHTAR	54	0550050060	60 MM BORU UZATMALI YILDIZ ANAHTAR	57	0600011010	10" KURBAĞACIK ANAHTAR PVC	57
0440032729	27X29 DÜZ YILDIZ ANAHTAR	54	0550050065	65 MM BORU UZATMALI YILDIZ ANAHTAR	57	0600011012	12" KURBAĞACIK ANAHTAR PVC	57
0440032732	27X32 DÜZ YILDIZ ANAHTAR	54	0550050070	70 MM BORU UZATMALI YILDIZ ANAHTAR	57	0600011015	15" KURBAĞACIK ANAHTAR PVC	57
0440033032	30X32 DÜZ YILDIZ ANAHTAR	54	0550050075	75 MM BORU UZATMALI YILDIZ ANAHTAR	57	0601010008	8 ELTA KURBAĞACIK ANAHTAR PVC	181
0450002108	8 Lİ ELTA YILDIZ ANAHTAR TK.	180	0550050080	80 MM BORU UZATMALI YILDIZ ANAHTAR	57	0601010010	10 ELTA KURBAĞACIK ANAHTAR PVC	181
0450002112	12 Lİ ELTA YILDIZ ANAHTAR TK.	180	0550050085	85 MM BORU UZATMALI YILDIZ ANAHTAR	57	0601010012	12 ELTA KURBAĞACIK ANAHTAR PVC	181

KOD CODE	ÜRÜN İSMİ PRODUCT NAME	SAYFA NO PAGE NUMBER
0615010200	200 MM AYARLI MONTAJ ANAHTARI	58
0637350140	60x140 MM KAYIŞLI FİLTRE SÖKECEĞİ	156
0637450140	60x140 MM ZİNCİRLİ FİLTRE SÖKECEĞİ	156
0637550010	AYARLI YAĞ FİLTRE SÖKECEĞİ YEDEK KELEPÇE	197
0637550100	100MM AYARLI YAĞ FİL.SÖKECEĞİ	156
0637650108	SAC YAĞ FİLTRE SÖKECEĞİ	156
0639050125	125 mm SEGMAN ÇEMBERİ	157
0639050175	175 mm SEGMAN ÇEMBERİ	157
0676050042	42 MM PLASTİK BORU KESME MAKASI	167
0676050063	63 MM PLASTİK BORU KESME MAKASI	167
0676550042	42 MM PLASTİK BORU KESME MAKAS BIÇAĞI	198
0676550063	63 MM PLASTİK BORU KESME MAKAS BIÇAĞI	198
0700050024	24 MM ÇATAL ÇAKMA ANAHTAR	56
0700050027	27 MM ÇATAL ÇAKMA ANAHTAR	56
0700050030	30 MM ÇATAL ÇAKMA ANAHTAR	56
0700050032	32 MM ÇATAL ÇAKMA ANAHTAR	56
0700050036	36 MM ÇATAL ÇAKMA ANAHTAR	56
0700050038	38 MM ÇATAL ÇAKMA ANAHTAR	56
0700050041	41 MM ÇATAL ÇAKMA ANAHTAR	56
0700050042	42 MM ÇATAL ÇAKMA ANAHTAR	56
0700050046	46 MM ÇATAL ÇAKMA ANAHTAR	56
0700050047	47 MM ÇATAL ÇAKMA ANAHTAR	56
0700050050	50 MM ÇATAL ÇAKMA ANAHTAR	56
0700050055	55 MM ÇATAL ÇAKMA ANAHTAR	56
0700050060	60 MM ÇATAL ÇAKMA ANAHTAR	56
0700050065	65 MM ÇATAL ÇAKMA ANAHTAR	56
0700050070	70 MM ÇATAL ÇAKMA ANAHTAR	56
0700050075	75 MM ÇATAL ÇAKMA ANAHTAR	56
0700050080	80 MM ÇATAL ÇAKMA ANAHTAR	56
0700050085	85 MM ÇATAL ÇAKMA ANAHTAR	56
0700050090	90 MM ÇATAL ÇAKMA ANAHTAR	56
0700050095	95 MM ÇATAL ÇAKMA ANAHTAR	56
0700050100	100 MM ÇATAL ÇAKMA ANAHTAR	56
0700050105	105 MM ÇATAL ÇAKMA ANAHTAR	56
0700050110	110 MM ÇATAL ÇAKMA ANAHTAR	56
0700050115	115 MM ÇATAL ÇAKMA ANAHTAR	56
0700050120	120 MM ÇATAL ÇAKMA ANAHTAR	56
0700050125	125 MM ÇATAL ÇAKMA ANAHTAR	56
0700050130	130 MM ÇATAL ÇAKMA ANAHTAR	56
0700050135	135 MM ÇATAL ÇAKMA ANAHTAR	56
0700050140	140 MM ÇATAL ÇAKMA ANAHTAR	56
0700050145	145 MM ÇATAL ÇAKMA ANAHTAR	56
0700050150	150 MM ÇATAL ÇAKMA ANAHTAR	56
0700050155	155 MM ÇATAL ÇAKMA ANAHTAR	56
0700050160	160 MM ÇATAL ÇAKMA ANAHTAR	56
0700050165	165 MM ÇATAL ÇAKMA ANAHTAR	56
0700050170	170 MM ÇATAL ÇAKMA ANAHTAR	56
0700050180	180 MM ÇATAL ÇAKMA ANAHTAR	56
0700050185	185 MM ÇATAL ÇAKMA ANAHTAR	56
0700050190	190 MM ÇATAL ÇAKMA ANAHTAR	56
0700050195	195 MM ÇATAL ÇAKMA ANAHTAR	56
0701050024	24 MM ELTA ÇATAL ÇAKMA ANAHTAR	181
0701050042	42 MM ELTA ÇATAL ÇAKMA ANAHTAR	181
0701050095	95 MM ELTA ÇATAL ÇAKMA ANAHTAR	181
0741050010	10 M MAKARALI UZATMA KABLOSU	157
0741050025	25 M MAKARALI UZATMA KABLOSU	157
0741050050	50 M MAKARALI UZATMA KABLOSU	157
0741550003	3 SIRALI TEL FIRÇA	157
0741550004	4 SIRALI TEL FIRÇA	157
0741550005	5 SIRALI TEL FIRÇA	157
0741550006	6 SIRALI TEL FIRÇA	157

KOD CODE	ÜRÜN İSMİ PRODUCT NAME	SAYFA NO PAGE NUMBER
0741650001	270 MM KIVRIK UÇLU FIRÇA	157
0750050024	24 MM YILDIZ ÇAKMA ANAHTAR	56
0750050027	27 MM YILDIZ ÇAKMA ANAHTAR	56
0750050030	30 MM YILDIZ ÇAKMA ANAHTAR	56
0750050032	32 MM YILDIZ ÇAKMA ANAHTAR	56
0750050036	36 MM YILDIZ ÇAKMA ANAHTAR	56
0750050038	38 MM YILDIZ ÇAKMA ANAHTAR	56
0750050041	41 MM YILDIZ ÇAKMA ANAHTAR	56
0750050042	42 MM YILDIZ ÇAKMA ANAHTAR	56
0750050046	46 MM YILDIZ ÇAKMA ANAHTAR	56
0750050047	47 MM YILDIZ ÇAKMA ANAHTAR	56
0750050050	50 MM YILDIZ ÇAKMA ANAHTAR	56
0750050055	55 MM YILDIZ ÇAKMA ANAHTAR	56
0750050060	60 MM YILDIZ ÇAKMA ANAHTAR	56
0750050065	65 MM YILDIZ ÇAKMA ANAHTAR	56
0750050070	70 MM YILDIZ ÇAKMA ANAHTAR	56
0750050075	75 MM YILDIZ ÇAKMA ANAHTAR	56
0750050080	80 MM YILDIZ ÇAKMA ANAHTAR	56
0750050085	85 MM YILDIZ ÇAKMA ANAHTAR	56
0750050090	90 MM YILDIZ ÇAKMA ANAHTAR	56
0750050095	95 MM YILDIZ ÇAKMA ANAHTAR	56
0750050100	100 MM YILDIZ ÇAKMA ANAHTAR	56
0750050105	105 MM YILDIZ ÇAKMA ANAHTAR	56
0750050110	110 MM YILDIZ ÇAKMA ANAHTAR	56
0750050115	115 MM YILDIZ ÇAKMA ANAHTAR	56
0750050120	120 MM YILDIZ ÇAKMA ANAHTAR	56
0750050125	125 MM YILDIZ ÇAKMA ANAHTAR	56
0750050130	130 MM YILDIZ ÇAKMA ANAHTAR	56
0750050135	135 MM YILDIZ ÇAKMA ANAHTAR	56
0750050140	140 MM YILDIZ ÇAKMA ANAHTAR	56
0750050145	145 MM YILDIZ ÇAKMA ANAHTAR	56
0750050150	150 MM YILDIZ ÇAKMA ANAHTAR	56
0750050155	155 MM YILDIZ ÇAKMA ANAHTAR	56
0750050160	160 MM YILDIZ ÇAKMA ANAHTAR	56
0750050165	165 MM YILDIZ ÇAKMA ANAHTAR	56
0750050170	170 MM YILDIZ ÇAKMA ANAHTAR	56
0750050180	180 MM YILDIZ ÇAKMA ANAHTAR	56
0751050042	42 MM ELTA YILDIZ ÇAKMA ANAHTAR	181
0751050070	70 MM ELTA YILDIZ ÇAKMA ANAHTAR	181
0751050085	85 MM ELTA YILDIZ ÇAKMA ANAHTAR	181
0860052528	25/28 KANCA ANAHTAR DÖRTGEN UÇLU	57
0860053032	30/32 KANCA ANAHTAR DÖRTGEN UÇLU	57
0860053436	34/36 KANCA ANAHTAR DÖRTGEN UÇLU	57
0860054042	40/42 KANCA ANAHTAR DÖRTGEN UÇLU	57
0860054550	45/50 KANCA ANAHTAR DÖRTGEN UÇLU	57
0860055255	52/55 KANCA ANAHTAR DÖRTGEN UÇLU	57
0860055862	58/62 KANCA ANAHTAR DÖRTGEN UÇLU	57
0860056875	68/75 KANCA ANAHTAR DÖRTGEN UÇLU	57
0860058090	80/90 KANCA ANAHTAR DÖRTGEN UÇLU	57
0860059510	95/100 KANCA ANAHTAR DÖRTGEN UÇLU	57
1107001042	42"LI BITS UÇLU LOKMA TAKIMI 1/4"	65
1107006014	14"LU DERİN LOKMA TAKIMI 1/4"	63
1107006015	15"LI 1/4" KARBÜRATÖR LOKMA TAKIMI	66

KOD CODE	ÜRÜN İSMİ PRODUCT NAME	SAYFA NO PAGE NUMBER
1107060004	04 MM 1/4" ALTI KÖŞE LOKMA ANAHTAR	63
1107060005	05 MM 1/4" ALTI KÖŞE LOKMA ANAHTAR	63
1107060006	06 MM 1/4" ALTI KÖŞE LOKMA ANAHTAR	63
1107060007	07 MM 1/4" ALTI KÖŞE LOKMA ANAHTAR	63
1107060008	08 MM 1/4" ALTI KÖŞE LOKMA ANAHTAR	63
1107060009	09 MM 1/4" ALTI KÖŞE LOKMA ANAHTAR	63
1107060010	10 MM 1/4" ALTI KÖŞE LOKMA ANAHTAR	63
1107060011	11 MM 1/4" ALTI KÖŞE LOKMA ANAHTAR	63
1107060012	12 MM 1/4" ALTI KÖŞE LOKMA ANAHTAR	63
1107060013	13 MM 1/4" ALTI KÖŞE LOKMA ANAHTAR	63
1107060045	4,5 MM 1/4" ALTI KÖŞE LOKMA ANAHTAR	63
1107060055	5,5 MM 1/4" ALTI KÖŞE LOKMA ANAHTAR	63
1107061103	3 MM ALLEN UÇLU LOKMA 1/4"	64
1107061104	4 MM ALLEN UÇLU LOKMA 1/4"	64
1107061105	5 MM ALLEN UÇLU LOKMA 1/4"	64
1107061106	6 MM ALLEN UÇLU LOKMA 1/4"	64
1107061107	7 MM ALLEN UÇLU LOKMA 1/4"	64
1107061108	8 MM ALLEN UÇLU LOKMA 1/4"	64
1107061110	10 MM ALLEN UÇLU LOKMA 1/4"	64
1107061125	2,5 MM ALLEN UÇLU LOKMA 1/4"	64
1107061208	T 8 TORX UÇLU LOKMA 1/4"	64
1107061209	T 9 TORX UÇLU LOKMA 1/4"	64
1107061210	T 10 TORX UÇLU LOKMA 1/4"	64
1107061215	T 15 TORX UÇLU LOKMA 1/4"	64
1107061220	T 20 TORX UÇLU LOKMA 1/4"	64
1107061225	T 25 TORX UÇLU LOKMA 1/4"	64
1107061227	T 27 TORX UÇLU LOKMA 1/4"	64
1107061230	T 30 TORX UÇLU LOKMA 1/4"	64
1107061240	T 40 TORX UÇLU LOKMA 1/4"	64
1107061308	TR 8 DELİKLİ TORK UÇLU LOKMA 1/4"	64
1107061309	TR 9 DELİKLİ TORK UÇLU LOKMA 1/4"	64
1107061310	TR 10 DELİKLİ TORK UÇLU LOKMA 1/4"	64
1107061315	TR 15 DELİKLİ TORK UÇLU LOKMA 1/4"	64
1107061320	TR 20 DELİKLİ TORK UÇLU LOKMA 1/4"	64
1107061325	TR 25 DELİKLİ TORK UÇLU LOKMA 1/4"	64
1107061327	TR 27 DELİKLİ TORK UÇLU LOKMA 1/4"	64
1107061330	TR 30 DELİKLİ TORK UÇLU LOKMA 1/4"	64
1107061340	TR 40 DELİKLİ TORK UÇLU LOKMA 1/4"	64
1107061403	3 MM DÜZ UÇLU LOKMA 1/4"	64
1107061404	4 MM DÜZ UÇLU LOKMA 1/4"	64
1107061407	7 MM DÜZ UÇLU LOKMA 1/4"	64
1107061408	8 MM DÜZ UÇLU LOKMA 1/4"	64
1107061410	10 MM DÜZ UÇLU LOKMA 1/4"	64
1107061435	3,5 MM DÜZ UÇLU LOKMA 1/4"	64
1107061445	4,5 MM DÜZ UÇLU LOKMA 1/4"	64
1107061455	5,5 MM DÜZ UÇLU LOKMA 1/4"	64
1107061465	6,5 MM DÜZ UÇLU LOKMA 1/4"	64
1107061501	PH1 YILDIZ UÇLU LOKMA 1/4"	65
1107061502	PH2 YILDIZ UÇLU LOKMA 1/4"	65
1107061503	PH3 YILDIZ UÇLU LOKMA 1/4"	65
1107061504	PH4 YILDIZ UÇLU LOKMA 1/4"	65
1107064004	4 MM 1/4" ALTI KÖŞE DERİN LOKMA ANAHTAR	63
1107064005	5 MM 1/4" ALTI KÖŞE DERİN LOKMA ANAHTAR	63

KOD CODE	ÜRÜN İSMİ PRODUCT NAME	SAYFA NO PAGE NUMBER	KOD CODE	ÜRÜN İSMİ PRODUCT NAME	SAYFA NO PAGE NUMBER	KOD CODE	ÜRÜN İSMİ PRODUCT NAME	SAYFA NO PAGE NUMBER
1107064006	6 MM 1/4" ALTI KÖŞE DERİN LOKMA ANAHTAR	63	1110060022	22 MM 3/8" LOKMA ANAHTAR ALTI KÖŞE	67	1113061227	T 27 LOKMALI STAR (TORX) UÇ	72
1107064007	7 MM 1/4" ALTI KÖŞE DERİN LOKMA ANAHTAR	63	1110060023	23 MM 3/8" LOKMA ANAHTAR ALTI KÖŞE	67	1113061230	T 30 LOKMALI STAR (TORX) UÇ	72
1107064008	8 MM 1/4" ALTI KÖŞE DERİN LOKMA ANAHTAR	63	1110069208	20,8 MM 3/8" BUJİ LOKMA LASTİKLİ	67	1113061240	T 40 LOKMALI STAR (TORX) UÇ	72
1107064009	9 MM 1/4" ALTI KÖŞE DERİN LOKMA ANAHTAR	63	1113001038	1/4" - 1/2" 35 PARÇA ALTI KÖŞE LOKMA ANH. TK	75	1113061245	T 45 LOKMALI STAR (TORX) UÇ	72
1107064010	10 MM 1/4" ALTI KÖŞE DERİN LOKMA ANAHTAR	63	1113001107	7" Lİ LOKMALI ALLEN UÇ TAKIMI 1/2"	72	1113061250	T 50 LOKMALI STAR (TORX) UÇ	72
1107064011	11 MM 1/4" ALTI KÖŞE DERİN LOKMA ANAHTAR	63	1113002017	17" Lİ LOKMA ANAHTAR TAKIMI 1/2" (U KOLSUZ)	76	1113061255	T 55 LOKMALI STAR (TORX) UÇ	72
1107064012	12 MM 1/4" ALTI KÖŞE DERİN LOKMA ANAHTAR	63	1113002024	24" Lİ LOKMA ANAHTAR TAKIMI 1/2" (U KOLSUZ)	76	1113061260	T 60 LOKMALI STAR (TORX) UÇ	72
1107064013	13 MM 1/4" ALTI KÖŞE DERİN LOKMA ANAHTAR	63	1113003020	1/2" MANYETİK LOKMALI UÇ TAKIMI 20 PARÇA	77	1113063008	08 MM 1/2" MANYETİK LOKMA ANH. ALTI KÖŞE	77
1107064055	5,5 MM 1/4" ALTI KÖŞE DERİN LOKMA ANAHTAR	63	1113006007	7" Lİ STAR (TORX) LOKMA TAKIMI 1/2"	71	1113063010	10 MM 1/2" MANYETİK LOKMA ANH. ALTI KÖŞE	77
1107065010	1/4" BİTS TUTUCU LOKMA MİKNAZISLI	66	1113006009	9" LU LOKMALI TORK UÇ TAKIMI 1/2"	72	1113063012	12 MM 1/2" MANYETİK LOKMA ANH. ALTI KÖŞE	77
1108006010	10 PARÇA 1/2" ALTI KÖŞE DERİN LOKMA TAKIMI	71	1113006017	1/2" LK. ALLEN UÇ VE STAR (TORK) UÇ TK. 17 PARÇA	73	1113063014	14 MM 1/2" MANYETİK LOKMA ANH. ALTI KÖŞE	77
1108060010	10 MM 1/2" DERİN LOKMA 6 KÖŞE	71	1113006145	LOKMA ANAHTAR SEHPASI (DOLU - 145)	69	1113063120	T 20 MANYETİK TORK UÇ 1/2"	77
1108060011	11 MM 1/2" DERİN LOKMA 6 KÖŞE	71	1113009003	1/2" ALAŞIMLI JANT LOKMA 3 PARÇA	80	1113063125	T 25 MANYETİK TORK UÇ 1/2"	77
1108060012	12 MM 1/2" DERİN LOKMA 6 KÖŞE	71	1113009007	7" Lİ ALAŞIMLI JANT LOKMA TK. 1/2"	80	1113063127	T 27 MANYETİK TORK UÇ 1/2"	77
1108060013	13 MM 1/2" DERİN LOKMA 6 KÖŞE	71	1113060210	1/2 E-10 MM STAR (TORX) LOKMA	71	1113063130	T 30 MANYETİK TORK UÇ 1/2"	77
1108060014	14 MM 1/2" DERİN LOKMA 6 KÖŞE	71	1113060212	1/2 E-12 MM STAR (TORX) LOKMA	71	1113063140	T 40 MANYETİK TORK UÇ 1/2"	77
1108060015	15 MM 1/2" DERİN LOKMA 6 KÖŞE	71	1113060214	1/2 E-14 MM STAR (TORX) LOKMA	71	1113063145	T 45 MANYETİK TORK UÇ 1/2"	77
1108060016	16 MM 1/2" DERİN LOKMA 6 KÖŞE	71	1113060216	1/2 E-16 MM STAR (TORX) LOKMA	71	1113063150	T 50 MANYETİK TORK UÇ 1/2"	77
1108060017	17 MM 1/2" DERİN LOKMA 6 KÖŞE	71	1113060218	1/2 E-18 MM STAR (TORX) LOKMA	71	1113063155	T 55 MANYETİK TORK UÇ 1/2"	77
1108060018	18 MM 1/2" DERİN LOKMA 6 KÖŞE	71	1113060220	1/2 E-20 MM STAR (TORX) LOKMA	71	1113063160	T 60 MANYETİK TORK UÇ 1/2"	77
1108060019	19 MM 1/2" DERİN LOKMA 6 KÖŞE	71	1113061008	8 MM LOKMA ANAHTAR 1/2"	69	1113063205	05 MM MANYETİK ALLEN UÇ 1/2"	77
1108067010	10 MM 1/2" HAVALI DERİN LOKMA 6 KÖŞE	81	1113061009	9 MM LOKMA ANAHTAR 1/2"	69	1113063206	06 MM MANYETİK ALLEN UÇ 1/2"	77
1108067011	11 MM 1/2" HAVALI DERİN LOKMA 6 KÖŞE	81	1113061010	10 MM LOKMA ANAHTAR 1/2"	69	1113063207	07 MM MANYETİK ALLEN UÇ 1/2"	77
1108067012	12 MM 1/2" HAVALI DERİN LOKMA 6 KÖŞE	81	1113061011	11 MM LOKMA ANAHTAR 1/2"	69	1113063208	08 MM MANYETİK ALLEN UÇ 1/2"	77
1108067013	13 MM 1/2" HAVALI DERİN LOKMA 6 KÖŞE	81	1113061012	12 MM LOKMA ANAHTAR 1/2"	69	1113063210	10 MM MANYETİK ALLEN UÇ 1/2"	77
1108067014	14 MM 1/2" HAVALI DERİN LOKMA 6 KÖŞE	81	1113061013	13 MM LOKMA ANAHTAR 1/2"	69	1113063212	12 MM MANYETİK ALLEN UÇ 1/2"	77
1108067015	15 MM 1/2" HAVALI DERİN LOKMA 6 KÖŞE	81	1113061014	14 MM LOKMA ANAHTAR 1/2"	69	1113063214	14 MM MANYETİK ALLEN UÇ 1/2"	77
1108067016	16 MM 1/2" HAVALI DERİN LOKMA 6 KÖŞE	81	1113061015	15 MM LOKMA ANAHTAR 1/2"	69	1113064105	5 MM UZUN ALLEN UÇLU LOKMA (100 MM)	72
1108067017	17 MM 1/2" HAVALI DERİN LOKMA 6 KÖŞE	81	1113061016	16 MM LOKMA ANAHTAR 1/2"	69	1113064106	6 MM UZUN ALLEN UÇLU LOKMA (100 MM)	72
1108067018	18 MM 1/2" HAVALI DERİN LOKMA 6 KÖŞE	81	1113061017	17 MM LOKMA ANAHTAR 1/2"	69	1113064107	7 MM UZUN ALLEN UÇLU LOKMA (100 MM)	72
1108067019	19 MM 1/2" HAVALI DERİN LOKMA 6 KÖŞE	81	1113061018	18 MM LOKMA ANAHTAR 1/2"	69	1113064108	8 MM UZUN ALLEN UÇLU LOKMA (100 MM)	72
1108067021	21 MM 1/2" HAVALI DERİN LOKMA 6 KÖŞE	81	1113061019	19 MM LOKMA ANAHTAR 1/2"	69	1113064110	10 MM UZUN ALLEN UÇLU LOKMA (100 MM)	72
1108067022	22 MM 1/2" HAVALI DERİN LOKMA 6 KÖŞE	81	1113061020	20 MM LOKMA ANAHTAR 1/2"	69	1113064112	12 MM UZUN ALLEN UÇLU LOKMA (100 MM)	72
1108067024	24 MM 1/2" HAVALI DERİN LOKMA 6 KÖŞE	81	1113061021	21 MM LOKMA ANAHTAR 1/2"	69	1113064114	14 MM UZUN ALLEN UÇLU LOKMA (100 MM)	72
1108067027	27 MM 1/2" HAVALI DERİN LOKMA 6 KÖŞE	81	1113061022	22 MM LOKMA ANAHTAR 1/2"	69	1113064117	17 MM UZUN ALLEN UÇLU LOKMA (100 MM)	72
1108067030	30 MM 1/2" HAVALI DERİN LOKMA 6 KÖŞE	81	1113061023	23 MM LOKMA ANAHTAR 1/2"	69	1113064220	T 20 UZUN STAR (TORX) UÇLU LOKMA (100 MM)	72
1108067032	32 MM 1/2" HAVALI DERİN LOKMA 6 KÖŞE	81	1113061024	24 MM LOKMA ANAHTAR 1/2"	69	1113064225	T 25 UZUN STAR (TORX) UÇLU LOKMA (100 MM)	72
1110006019	19' LU 3/8" ALTI KÖŞE LOKMA TAKIMI	68	1113061025	25 MM LOKMA ANAHTAR 1/2"	69	1113064227	T 27 UZUN STAR (TORX) UÇLU LOKMA (100 MM)	72
1110060006	06 MM 3/8" LOKMA ANAHTAR ALTI KÖŞE	67	1113061026	26 MM LOKMA ANAHTAR 1/2"	69	1113064230	T 30 UZUN STAR (TORX) UÇLU LOKMA (100 MM)	72
1110060007	07 MM 3/8" LOKMA ANAHTAR ALTI KÖŞE	67	1113061027	27 MM LOKMA ANAHTAR 1/2"	69	1113064240	T 40 UZUN STAR (TORX) UÇLU LOKMA (100 MM)	72
1110060008	08 MM 3/8" LOKMA ANAHTAR ALTI KÖŞE	67	1113061028	28 MM LOKMA ANAHTAR 1/2"	69	1113064245	T 45 UZUN STAR (TORX) UÇLU LOKMA (100 MM)	72
1110060009	09 MM 3/8" LOKMA ANAHTAR ALTI KÖŞE	67	1113061029	29 MM LOKMA ANAHTAR 1/2"	69	1113064250	T 50 UZUN STAR (TORX) UÇLU LOKMA (100 MM)	72
1110060010	10 MM 3/8" LOKMA ANAHTAR ALTI KÖŞE	67	1113061030	30 MM LOKMA ANAHTAR 1/2"	69	1113064255	T 55 UZUN STAR (TORX) UÇLU LOKMA (100 MM)	72
1110060011	11 MM 3/8" LOKMA ANAHTAR ALTI KÖŞE	67	1113061032	32 MM LOKMA ANAHTAR 1/2"	69	1113064260	T 60 UZUN STAR (TORX) UÇLU LOKMA (100 MM)	72
1110060012	12 MM 3/8" LOKMA ANAHTAR ALTI KÖŞE	67	1113061105	5 MM LOKMALI ALLEN UÇ	72	1113065010	1/2" BİTS TUTUCU LOKMA	74
1110060013	13 MM 3/8" LOKMA ANAHTAR ALTI KÖŞE	67	1113061106	6 MM LOKMALI ALLEN UÇ	72	1113067010	10 MM HAVALI LOKMA ANAHTAR 1/2" ALTI KÖŞE	81
1110060014	14 MM 3/8" LOKMA ANAHTAR ALTI KÖŞE	67	1113061107	7 MM LOKMALI ALLEN UÇ	72	1113067011	11 MM HAVALI LOKMA ANAHTAR 1/2" ALTI KÖŞE	81
1110060015	15 MM 3/8" LOKMA ANAHTAR ALTI KÖŞE	67	1113061108	8 MM LOKMALI ALLEN UÇ	72	1113067012	12 MM HAVALI LOKMA ANAHTAR 1/2" ALTI KÖŞE	81
1110060016	16 MM 3/8" LOKMA ANAHTAR ALTI KÖŞE	67	1113061110	10 MM LOKMALI ALLEN UÇ	72	1113067013	13 MM HAVALI LOKMA ANAHTAR 1/2" ALTI KÖŞE	81
1110060017	17 MM 3/8" LOKMA ANAHTAR ALTI KÖŞE	67	1113061112	12 MM LOKMALI ALLEN UÇ	72	1113067014	14 MM HAVALI LOKMA ANAHTAR 1/2" ALTI KÖŞE	81
1110060018	18 MM 3/8" LOKMA ANAHTAR ALTI KÖŞE	67	1113061114	14 MM LOKMALI ALLEN UÇ	72	1113067015	15 MM HAVALI LOKMA ANAHTAR 1/2" ALTI KÖŞE	81
1110060019	19 MM 3/8" LOKMA ANAHTAR ALTI KÖŞE	67	1113061220	T 20 LOKMALI STAR (TORX) UÇ	72	1113067016	16 MM HAVALI LOKMA ANAHTAR 1/2" ALTI KÖŞE	81
1110060021	21 MM 3/8" LOKMA ANAHTAR ALTI KÖŞE	67	1113061225	T 25 LOKMALI STAR (TORX) UÇ	72	1113067017	17 MM HAVALI LOKMA ANAHTAR 1/2" ALTI KÖŞE	81

KOD CODE	ÜRÜN İSMİ PRODUCT NAME	SAYFA NO PAGE NUMBER
1113067018	18 MM HAVALI LOKMA ANAHTAR 1/2" ALTI KÖŞE	81
1113067019	19 MM HAVALI LOKMA ANAHTAR 1/2" ALTI KÖŞE	81
1113067021	21 MM HAVALI LOKMA ANAHTAR 1/2" ALTI KÖŞE	81
1113067022	22 MM HAVALI LOKMA ANAHTAR 1/2" ALTI KÖŞE	81
1113067024	24 MM HAVALI LOKMA ANAHTAR 1/2" ALTI KÖŞE	81
1113067027	27 MM HAVALI LOKMA ANAHTAR 1/2" ALTI KÖŞE	81
1113069160	16 MM BUJİ LOKMA LASTİKLİ	70
1113069208	20.8 MM BUJİ LOKMA LASTİKLİ	70
1113316100	LOKMA ANAHTAR SEHPASI BOŞ	202
1114006024	1/2" ONİKİ KÖŞE 24"LÜ LOKMA ANH. TK. U KOLSUZ	76
1114061010	10 MM LOKMA ANAHTAR ONİKİ KÖŞE 1/2"	70
1114061011	11 MM LOKMA ANAHTAR ONİKİ KÖŞE 1/2"	70
1114061012	12 MM LOKMA ANAHTAR ONİKİ KÖŞE 1/2"	70
1114061013	13 MM LOKMA ANAHTAR ONİKİ KÖŞE 1/2"	70
1114061014	14 MM LOKMA ANAHTAR ONİKİ KÖŞE 1/2"	70
1114061015	15 MM LOKMA ANAHTAR ONİKİ KÖŞE 1/2"	70
1114061016	16 MM LOKMA ANAHTAR ONİKİ KÖŞE 1/2"	70
1114061017	17 MM LOKMA ANAHTAR ONİKİ KÖŞE 1/2"	70
1114061018	18 MM LOKMA ANAHTAR ONİKİ KÖŞE 1/2"	70
1114061019	19 MM LOKMA ANAHTAR ONİKİ KÖŞE 1/2"	70
1114061020	20 MM LOKMA ANAHTAR ONİKİ KÖŞE 1/2"	70
1114061021	21 MM LOKMA ANAHTAR ONİKİ KÖŞE 1/2"	70
1114061022	22 MM LOKMA ANAHTAR ONİKİ KÖŞE 1/2"	70
1114061023	23 MM LOKMA ANAHTAR ONİKİ KÖŞE 1/2"	70
1114061024	24 MM LOKMA ANAHTAR ONİKİ KÖŞE 1/2"	70
1114061026	26 MM LOKMA ANAHTAR ONİKİ KÖŞE 1/2"	70
1114061027	27 MM LOKMA ANAHTAR ONİKİ KÖŞE 1/2"	70
1114061028	28 MM LOKMA ANAHTAR ONİKİ KÖŞE 1/2"	70
1114061030	30 MM LOKMA ANAHTAR ONİKİ KÖŞE 1/2"	70
1114061032	32 MM LOKMA ANAHTAR ONİKİ KÖŞE 1/2"	70
1114064005	M 5 1/2" 12İ KÖŞE LOKMALI BİT UÇ KISA (60 MM)	73
1114064006	M 6 1/2" 12 KÖŞE LOKMALI BİT UÇ KISA (60 MM)	73
1114064008	M 8 1/2" 12 KÖŞE LOKMALI BİT UÇ KISA (60 MM)	73
1114064010	M 10 1/2" 12 KÖŞE LOKMALI BİT UÇ KISA (60 MM)	73
1114064012	M 12 1/2" 12 KÖŞE LOKMALI BİT UÇ KISA (60 MM)	73
1114064106	M 6 1/2" 12 KÖŞE LOKMALI BİT UÇ ORTA (80 MM)	73
1114064108	M 8 1/2" 12 KÖŞE LOKMALI BİT UÇ ORTA (80 MM)	73
1114064110	M 10 1/2" 12 KÖŞE LOKMALI BİT UÇ ORTA (80 MM)	73
1114064112	M 12 1/2" 12 KÖŞE LOKMALI BİT UÇ ORTA (80 MM)	73
1114064114	M 14 1/2" 12 KÖŞE LOKMALI BİT UÇ ORTA (80 MM)	73
1114064208	M 8 1/2" 12 KÖŞE LOKMALI BİT UÇ UZUN (140 MM)	73
1114064210	M 10 1/2" 12 KÖŞE LOKMALI BİT UÇ UZUN (140 MM)	73
1114064212	M 12 1/2" 12 KÖŞE LOKMALI BİT UÇ UZUN (140 MM)	73
1114064214	M 14 1/2" 12 KÖŞE LOKMALI BİT UÇ UZUN (140MM)	73
1114064216	M 16 1/2" 12 KÖŞE LOKMALI BİT UÇ UZUN (140 MM)	73
1114065004	M 4 1/2 LOKMALI (RİBE) BİT UÇ	73
1114065005	M 5 1/2 LOKMALI (RİBE) BİT UÇ	73
1114065006	M 6 1/2 LOKMALI (RİBE) BİT UÇ	73
1114065007	M 7 1/2 LOKMALI (RİBE) BİT UÇ	73
1114065008	M 8 1/2 LOKMALI (RİBE) BİT UÇ	73
1114065009	M 9 1/2 LOKMALI (RİBE) BİT UÇ	73
1114065010	M 10 1/2 LOKMALI (RİBE) BİT UÇ	73
1114065011	M 10,5 1/2 LOKMALI (RİBE) BİT UÇ	73

KOD CODE	ÜRÜN İSMİ PRODUCT NAME	SAYFA NO PAGE NUMBER
1114065012	M 12 1/2 LOKMALI (RİBE) BİT UÇ	73
1114065013	M 13 1/2 LOKMALI (RİBE) BİT UÇ	73
1114065014	M 14 1/2 LOKMALI (RİBE) BİT UÇ	73
1114065016	M 16 1/2 LOKMALI (RİBE) BİT UÇ	73
1115002017	17" Lİ ELTA ALTIKÖŞE LOKMA ANH. TAKIM U KOLSUZ	183
1115002024	24" LÜ ELTA ALTIKÖŞE LOKMA ANH. TAKIM U KOLSUZ	183
1115006018	18" Lİ ELTA LOKMA ANAHTAR TK. 1/2"	183
1115006010	10 MM ELTA LOKMA ANAHTAR 1/2"	182
1115006011	11 MM ELTA LOKMA ANAHTAR 1/2"	182
1115006012	12 MM ELTA LOKMA ANAHTAR 1/2"	182
1115006013	13 MM ELTA LOKMA ANAHTAR 1/2"	182
1115006014	14 MM ELTA LOKMA ANAHTAR 1/2"	182
1115006015	15 MM ELTA LOKMA ANAHTAR 1/2"	182
1115006016	16 MM ELTA LOKMA ANAHTAR 1/2"	182
1115006017	17 MM ELTA LOKMA ANAHTAR 1/2"	182
1115006018	18 MM ELTA LOKMA ANAHTAR 1/2"	182
1115006019	19 MM ELTA LOKMA ANAHTAR 1/2"	182
1115006020	20 MM ELTA LOKMA ANAHTAR 1/2"	182
1115006021	21 MM ELTA LOKMA ANAHTAR 1/2"	182
1115006022	22 MM ELTA LOKMA ANAHTAR 1/2"	182
1115006023	23 MM ELTA LOKMA ANAHTAR 1/2"	182
1115006024	24 MM ELTA LOKMA ANAHTAR 1/2"	182
1115006026	26 MM ELTA LOKMA ANAHTAR 1/2"	182
1115006027	27 MM ELTA LOKMA ANAHTAR 1/2"	182
1115006028	28 MM ELTA LOKMA ANAHTAR 1/2"	182
1115006030	30 MM ELTA LOKMA ANAHTAR 1/2"	182
1115006032	32 MM ELTA LOKMA ANAHTAR 1/2"	182
1115067010	10 MM 1/2" ELTA HAVALI LOKMA ANAH.	184
1115067011	11 MM 1/2" ELTA HAVALI LOKMA ANAH.	184
1115067012	12 MM 1/2" ELTA HAVALI LOKMA ANAH.	184
1115067013	13 MM 1/2" ELTA HAVALI LOKMA ANAH.	184
1115067014	14 MM 1/2" ELTA HAVALI LOKMA ANAH.	184
1115067015	15 MM 1/2" ELTA HAVALI LOKMA ANAH.	184
1115067016	16 MM 1/2" ELTA HAVALI LOKMA ANAH.	184
1115067017	17 MM 1/2" ELTA HAVALI LOKMA ANAH.	184
1115067018	18 MM 1/2" ELTA HAVALI LOKMA ANAH.	184
1115067019	19 MM 1/2" ELTA HAVALI LOKMA ANAH.	184
1115067021	21 MM 1/2" ELTA HAVALI LOKMA ANAH.	184
1115067022	22 MM 1/2" ELTA HAVALI LOKMA ANAH.	184
1115067024	24 MM 1/2" ELTA HAVALI LOKMA ANAH.	184
1115067027	27 MM 1/2" ELTA HAVALI LOKMA ANAH.	184
1119006114	14" LÜ AGIR TIP ALTI KÖŞE LOKMA AN.TK. 3/4"	79
1119061022	22 MM AGIR TIP LOKMA ANAHTAR	78
1119061024	24 MM AGIR TIP LOKMA ANAHTAR	78
1119061027	27 MM AGIR TIP LOKMA ANAHTAR	78
1119061030	30 MM AGIR TIP LOKMA ANAHTAR	78
1119061032	32 MM AGIR TIP LOKMA ANAHTAR	78
1119061034	34 MM AGIR TIP LOKMA ANAHTAR	78
1119061036	36 MM AGIR TIP LOKMA ANAHTAR	78
1119061038	38 MM AGIR TIP LOKMA ANAHTAR	78
1119061041	41 MM AGIR TIP LOKMA ANAHTAR	78
1119061046	46 MM AGIR TIP LOKMA ANAHTAR	78
1119061050	50 MM AGIR TIP LOKMA ANAHTAR	78

KOD CODE	ÜRÜN İSMİ PRODUCT NAME	SAYFA NO PAGE NUMBER
1119061055	55 MM AGIR TIP LOKMA ANAHTAR	78
1119061060	60 MM AGIR TIP LOKMA ANAHTAR	78
1119067019	19 MM HAVALI LOKMA ALTI KÖŞE 3/4"	82
1119067021	21 MM HAVALI LOKMA ALTI KÖŞE 3/4"	82
1119067022	22 MM HAVALI LOKMA ALTI KÖŞE 3/4"	82
1119067024	24 MM HAVALI LOKMA ALTI KÖŞE 3/4"	82
1119067027	27 MM HAVALI LOKMA ALTI KÖŞE 3/4"	82
1119067030	30 MM HAVALI LOKMA ALTI KÖŞE 3/4"	82
1119067032	32 MM HAVALI LOKMA ALTI KÖŞE 3/4"	82
1119067034	34 MM HAVALI LOKMA ALTI KÖŞE 3/4"	82
1119067036	36 MM HAVALI LOKMA ALTI KÖŞE 3/4"	82
1119067041	41 MM HAVALI LOKMA ALTI KÖŞE 3/4"	82
1119067046	46 MM HAVALI LOKMA ALTI KÖŞE 3/4"	82
1120006014	14" LÜ AGIRTIP LOKMA AN. ONİKİ KÖŞE TK. 3/4"	79
1120061022	22 MM AGIRTIP LOKMA AN. ONİKİ KÖŞE 3/4"	78
1120061024	24 MM AGIRTIP LOKMA AN. ONİKİ KÖŞE 3/4"	78
1120061027	27 MM AGIRTIP LOKMA AN. ONİKİ KÖŞE 3/4"	78
1120061030	30 MM AGIRTIP LOKMA AN. ONİKİ KÖŞE 3/4"	78
1120061032	32 MM AGIRTIP LOKMA AN. ONİKİ KÖŞE 3/4"	78
1120061034	34 MM AGIRTIP LOKMA AN. ONİKİ KÖŞE 3/4"	78
1120061036	36 MM AGIRTIP LOKMA AN. ONİKİ KÖŞE 3/4"	78
1120061041	41 MM AGIRTIP LOKMA AN. ONİKİ KÖŞE 3/4"	78
1120061046	46 MM AGIRTIP LOKMA AN. ONİKİ KÖŞE 3/4"	78
1120061050	50 MM AGIRTIP LOKMA AN. ONİKİ KÖŞE 3/4"	78
1121060022	22 MM ELTA LOKMA ANAHTAR 3/4"	184
1121060024	24 MM ELTA LOKMA ANAHTAR 3/4"	184
1121060027	27 MM ELTA LOKMA ANAHTAR 3/4"	184
1121060030	30 MM ELTA LOKMA ANAHTAR 3/4"	184
1121060034	34 MM ELTA LOKMA ANAHTAR 3/4"	184
1121060041	41 MM ELTA LOKMA ANAHTAR 3/4"	184
1121060046	46 MM ELTA LOKMA ANAHTAR 3/4"	184
1121060050	50 MM ELTA LOKMA ANAHTAR 3/4"	184
1121060055	55 MM ELTA LOKMA ANAHTAR 3/4"	184
1121060060	60 MM ELTA LOKMA ANAHTAR 3/4"	184
1121067019	19 MM ELTA HAVALI LOKMA ANAHTAR 3/4"	185
1121067022	22 MM ELTA HAVALI LOKMA ANAHTAR 3/4"	185
1121067024	24 MM ELTA HAVALI LOKMA ANAHTAR 3/4"	185
1121067027	27 MM ELTA HAVALI LOKMA ANAHTAR 3/4"	185
1121067030	30 MM ELTA HAVALI LOKMA ANAHTAR 3/4"	185
1121067034	34 MM ELTA HAVALI LOKMA ANAHTAR 3/4"	185
1121067041	41 MM ELTA HAVALI LOKMA ANAHTAR 3/4"	185
1121067046	46 MM ELTA HAVALI LOKMA ANAHTAR 3/4"	185
1125067024	24 MM HAVALI LOKMA 1"	83
1125067027	27 MM HAVALI LOKMA 1"	83
1125067030	30 MM HAVALI LOKMA 1"	83
1125067032	32 MM HAVALI LOKMA 1"	83
1125067033	33 MM HAVALI LOKMA 1"	83
1125067034	34 MM HAVALI LOKMA 1"	83
1125067036	36 MM HAVALI LOKMA 1"	83
1125067038	38 MM HAVALI LOKMA 1"	83
1125067041	41 MM HAVALI LOKMA 1"	83
1125067046	46 MM HAVALI LOKMA 1"	83
1125067050	50 MM HAVALI LOKMA 1"	83

KOD CODE	ÜRÜN İSMİ PRODUCT NAME	SAYFA NO PAGE NUMBER	KOD CODE	ÜRÜN İSMİ PRODUCT NAME	SAYFA NO PAGE NUMBER	KOD CODE	ÜRÜN İSMİ PRODUCT NAME	SAYFA NO PAGE NUMBER
1125067055	55 MM HAVALI LOKMA 1"	83	1510060007	3/8"FX1/2"M LOKMA ADAPTÖRÜ 3/8"	68	1525067250	250 MM HAVALI LOKMA ARA KOL 1"	83
1125067060	60 MM HAVALI LOKMA 1"	83	1510060056	56,5 MM MAFSAL 3/8"	67	1525067330	330 MM HAVALI LOKMA ARA KOL 1"	83
1207068008	08 MM 1/4" SEKİZ KÖŞE LOKMA ANAHTAR	63	1510060075	75 MM ORTA ARA KOL 3/8"	67	1607060420	4-20 Nm CİRCİRLİ TORK ANAHTAR 1/4"	87
1207068010	10 MM 1/4" SEKİZ KÖŞE LOKMA ANAHTAR	63	1510060150	150 MM UZUN ARA KOL 3/8"	67	1610060100	2.5-11 Nm TORK ANAHTAR 3/8"	87
1225060036	36 MM LOKMA 1"	80	1510060200	200 MM CİRCİR KOLU 6 KÖŞE 3/8"	67	1610060300	7-33 Nm TORK ANAHTAR 3/8"	87
1225060041	41 MM LOKMA 1"	80	1510060215	215 MM MAFSALLI KOL 3/8"	68	1610062010	20-100 Nm CİRCİRLİ TORK ANAHTAR 3/8"	87
1225060046	46 MM LOKMA 1"	80	1510061200	200 MM T KOL 3/8"	68	1613061200	25-135 Nm TORK ANAHTAR 1/2"	87
1225060050	50 MM LOKMA 1"	80	1513060002	1/2"Fx3/8"M LOKMA ADAPTÖRÜ	74	1613062000	50-225 Nm TORK ANAHTAR 1/2"	87
1225060055	55 MM LOKMA 1"	80	1513060003	1/2"Fx3/4"M LOKMA ADAPTÖRÜ	74	1613063000	70-330 Nm TORK ANAHTAR 1/2"	87
1225060060	60 MM LOKMA 1"	80	1513060032	250 MM CİRCİR KOLU (32 DİŞ) 1/2"	74	1613064020	40-200 Nm CİRCİRLİ TORK ANAHTARI 1/2"	87
1413006024	1/2" ONİKİ KÖŞE 24"LÜ LK. ANH.TK. U KOLSUZ SAE	76	1513060072	250 MM MAXGEAR CİRCİR KL.(RATCHET HANDLE) (72 DİŞ) 1/2"	74	1613066034	60-340 Nm CİRCİRLİ TORK ANAHTARI 1/2"	87
1413061008	5/16" SAE LOKMA ANAH. ONİKİ KÖŞE	70	1513062250	250 MM T KOL 1/2"	74	1619061060	100-600 Nm TORK ANAHTAR 3/4"	87
1413061010	7/16 SAE LOKMA ANAH. ONİKİ KÖŞE	70	1513064070	70 MM MAFSAL 1/2"	74	1619062080	200-800 Nm TORK ANAHTAR 3/4"	87
1413061011	15/32 SAE LOKMA ANAH. ONİKİ KÖŞE	70	1513064075	75 MM ARA KOL 1/2"	74	1800002108	8 LI KOVAN ANAHTAR TAKIMI	84
1413061012	1/2 SAE LOKMA ANAH. ONİKİ KÖŞE	70	1513064125	125 MM ORTA ARA KOL 1/2"	74	1800070607	06x07 MM KOVAN ANAHTAR İKİ AĞIZ	84
1413061013	9/16 SAE LOKMA ANAH. ONİKİ KÖŞE	70	1513064250	250 MM UZUN ARA KOL 1/2"	74	1800070809	08x09 MM KOVAN ANAHTAR İKİ AĞIZ	84
1413061014	19/32 SAE LOKMA ANAH. ONİKİ KÖŞE	70	1513065250	1/2" T KOL ADAPTÖR	74	1800071011	10x11 MM KOVAN ANAHTAR İKİ AĞIZ	84
1413061015	5/8 SAE LOKMA ANAH. ONİKİ KÖŞE	70	1513067002	1/2"Fx3/8"M HAVALI LOKMA ADAPTÖRÜ	81	1800071213	12x13 MM KOVAN ANAHTAR İKİ AĞIZ	84
1413061016	11/16 SAE LOKMA ANAH. ONİKİ KÖŞE	70	1513067003	1/2"Fx3/4"M HAVALI LOKMA ADAPTÖRÜ	81	1800071415	14x15 MM KOVAN ANAHTAR İKİ AĞIZ	84
1413061017	3/4 SAE LOKMA ANAH. ONİKİ KÖŞE	70	1513067075	75 MM HAVALI LOKMA MAFSAL 1/2"	81	1800071617	16x17 MM KOVAN ANAHTAR İKİ AĞIZ	84
1413061020	25/32 SAE LOKMA ANAH. ONİKİ KÖŞE	70	1513067125	125 MM HAVALI LOKMA ARA KOL 1/2"	81	1800071819	18x19 MM KOVAN ANAHTAR İKİ AĞIZ	84
1413061021	13/16 SAE LOKMA ANAH. ONİKİ KÖŞE	70	1513067250	250 MM HAVALI LOKMA ARA KOL 1/2"	81	1800072022	20x22 MM KOVAN ANAHTAR İKİ AĞIZ	84
1413061022	7/8 SAE LOKMA ANAH. ONİKİ KÖŞE	70	1514064025	250 MM ELTA T KOL 1/2"	182	1800072123	21x23 MM KOVAN ANAHTAR İKİ AĞIZ	84
1413061024	15/16 SAE LOKMA ANAH. ONİKİ KÖŞE	70	1514064065	65 MM ELTA MAFSAL 1/2"	182	1800072224	22x24 MM KOVAN ANAHTAR İKİ AĞIZ	84
1413061025	1" SAE LOKMA ANAH. ONİKİ KÖŞE	70	1514064125	125 MM ELTA ORTA ARA KOL 1/2"	182	1800072426	24x26 MM KOVAN ANAHTAR İKİ AĞIZ	84
1413061027	1 1/16 SAE LOKMA ANAH. ONİKİ KÖŞE	70	1514064250	250 MM ELTA UZUN ARA KOL 1/2"	182	1800072427	24x27 MM KOVAN ANAHTAR İKİ AĞIZ	84
1413061029	1 1/8 SAE LOKMA ANAH. ONİKİ KÖŞE	70	1514064420	420 MM ELTA U KOL 1/2"	183	1800072528	25x28 MM KOVAN ANAHTAR İKİ AĞIZ	84
1413061030	1 3/16 SAE LOKMA ANAH. ONİKİ KÖŞE	70	1514065250	250 MM ELTA CİRCİR KOLU 1/2"	183	1800072732	27x32 MM KOVAN ANAHTAR İKİ AĞIZ	84
1413061032	1 1/4 SAE LOKMA ANAH. ONİKİ KÖŞE	70	1514066250	1/2" ELTA T KOL ADAPTÖR	182	1801070607	06X07 ELTA KOVAN ANAHTAR	181
1413061095	3/8 SAE LOKMA ANAH. ONİKİ KÖŞE	70	1514067125	125 MM ELTA HAVALI ORTA ARA KOL 1/2"	184	1801072022	20X22 ELTA KOVAN ANAHTAR	181
1419006114	14"LÜ AĞIR TIP SAE LOKMA AN.ONİKİ KÖŞE TK.	79	1514067250	250 MM ELTA HAVALI ORTA ARA KOL 1/2"	184	1801072123	21X23 ELTA KOVAN ANAHTAR	181
1419061022	7/8" AĞIRTIP SAE LOKMA ANAH.ONİKİ KÖŞE	78	1519060001	3/4"Fx1"M LOKMA ADAPTÖRÜ 3/4"	79	1801072426	24X26 ELTA KOVAN ANAHTAR	181
1419061024	15/16" AĞIRTIP SAE LOKMA ANAH.ONİKİ KÖŞE	78	1519060008	3/4"Fx1/2"M LOKMA ADAPTÖRÜ 3/4"	79	1801072528	25X28 ELTA KOVAN ANAHTAR	181
1419061025	1" AĞIRTIP SAE LOKMA ANAH.ONİKİ KÖŞE	78	1519064200	200 MM AGIR ORTA ARA KOL	78	1801072732	27X32 ELTA KOVAN ANAHTAR	181
1419061027	1 1/16" AĞIRTIP SAE LOKMA ANAH.ONİKİ KÖŞE	78	1519064400	400 MM AGIR UZUN ARA KOL	78	1840080500	500 MM MAFSALLI T KOL ADAPTÖR	86
1419061028	1 1/8" AĞIRTIP SAE LOKMA ANAH.ONİKİ KÖŞE	78	1519064500	500 MM AGIR " T " KOL	79	1841070021	21 MM BİR AĞIZ KOVAN ANAHTAR VE MİLİ (TAKIM2)	84
1419061032	1 1/4" AĞIRTIP SAE LOKMA ANAH. ONİKİ KÖŞE	78	1519064510	510 MM AGIR CİRCİR KOLU	78	1845080160	16 MM MAFSALLI BUJİ LOKMA	86
1419061033	1 5/16" AĞIRTIP SAE LOKMA ANAH.ONİKİ KÖŞE	78	1519067011	3/4"FX1/2"M HAVALI LOKMA ADAPTÖRÜ 3/4"	82	1845080208	20.8 MAFSALLI BUJİ LOKMA	86
1419061035	1 3/8" AĞIRTIP SAE LOKMA ANAH.ONİKİ KÖŞE	78	1519067108	108 MM HAVALI LOKMA MAFSAL 3/4"	82	1850071120	10X120 KOVAN ANAH.MİLİ	84
1419061036	1 7/16" AĞIRTIP SAE LOKMA ANAH.ONİKİ KÖŞE	78	1519067175	175 MM HAVALI LOKMA ARA KOL 3/4"	82	1850071200	10x200 KOVAN ANAHTAR MİLİ	84
1419061038	1 1/2" AĞIRTIP SAE LOKMA ANAH.ONİKİ KÖŞE	78	1519067250	250 MM HAVALI LOKMA ARA KOL 3/4"	82	1850075125	5x125 KOVAN ANAHTAR MİLİ	84
1419061041	1 5/8" AĞIRTIP SAE LOKMA ANAH.ONİKİ KÖŞE	78	1519067330	330 MM HAVALI LOKMA ARA KOL 3/4"	82	1850078180	8x180 KOVAN ANAHTAR MİLİ	84
1419061044	1 3/4" AĞIRTIP SAE LOKMA ANAH.ONİKİ KÖŞE	78	1521064200	200 MM ELTA ORTA ARA KOL 3/4"	184	1850091630	18x630 BIJON ANAHTAR MİLİ	84
1419061046	1 13/16" AĞIRTIP SAE LOKMA ANAH.ONİKİ KÖŞE	78	1521064400	400 MM ELTA UZUN ARA KOL 3/4"	184	1855080008	08 MM T KOL MAFSALLI LOKMA	86
1419061047	1 7/8" AĞIRTIP SAE LOKMA ANAH.ONİKİ KÖŞE	78	1521064500	500 MM ELTA T KOL 3/4"	184	1855080010	10 MM T KOL MAFSALLI LOKMA	86
1419061050	2" AĞIRTIP SAE LOKMA ANAH.ONİKİ KÖŞE	78	1521067108	108 MM ELTA HAVALI LOKMA MAFSAL 3/4"	185	1855080012	12 MM T KOL MAFSALLI LOKMA	86
1507060004	1/4"FX3/8"M LOKMA ADAPTÖRÜ	66	1521067175	175 MM ELTA HAVALI LOKMA ARA KOL 3/4"	185	1855080013	13 MM T KOL MAFSALLI LOKMA	86
1507060038	38 MM MAFSAL 1/4"	65	1521067250	250 MM ELTA HAVALI LOKMA ARA KOL 3/4"	185	1855080017	17 MM T KOL MAFSALLI LOKMA	86
1507060050	50 MM ORTA ARA KOL 1/4"	65	1521067330	330 MM ELTA HAVALI LOKMA ARA KOL 3/4"	185	1855080019	19 MM T KOL MAFSALLI LOKMA	86
1507060100	100 MM UZUN ARA KOL 1/4"	65	1525060005	1"FX3/4"M LOKMA ADAPTÖRÜ 1"	80	1857080013	13 MM T KOL LOKMA	86
1507062140	140 MM CİRCİR KOLU 1/4" PLASTİK SAPLI	65	1525067015	1"FX3/4"M HAVALI LOKMA ADAPTÖRÜ	83	1857080017	17 MM T KOL LOKMA	86
1507064080	1/4" DERİN LOKMA TORNAVİDA ADAP.	66	1525067128	128 MM HAVALI LOKMA MAFSAL 1"	83	1870092427	24X27 AGIR TIP BIJON ANAHTAR	84
1507064115	115 MM T KOL ADAPTÖR	65	1525067175	175 MM HAVALI LOKMA ARA KOL 1"	83	1870092730	27X30 AGIR TIP BIJON ANAHTARI	84

KOD CODE	ÜRÜN İSMİ PRODUCT NAME	SAYFA NO PAGE NUMBER
1870092732	27X32 AĞIR TIP BİJON ANAHTARI	84
1870093032	30X32 AĞIR TIP BİJON ANAHTARI	84
1870093233	32X33 AĞIR TIP BİJON ANAHTARI	84
1874092224	22X24 BİJON ANAHTAR KISA	84
1874092427	24X27 BİJON ANAHTAR KISA	84
1875092224	22X24 ELTA AĞIR BİJON ANAHTAR	181
1940090017	17 MM PİPO BİJON ANAHTAR	85
1940090019	19 MM (3/4) PİPO BİJON ANAHTAR	85
1940090021	21 MM (13/16) PİPO BİJON ANAHTAR	85
1975091322	1/2 ADAPTÖRLÜ BİJON AN.İSTAVROZ	85
1975091719	17X19-21(13/16)X22 İSTAVROZ ANAHTAR	85
2100100008	8" STİLSON BORU ANAHTARI	91
2100100010	10" STİLSON BORU ANAHTARI	91
2100100012	12" STİLSON BORU ANAHTARI	91
2100100014	14" STİLSON BORU ANAHTARI	91
2100100018	18" STİLSON BORU ANAHTARI	91
2100100024	24" STİLSON BORU ANAHTAR	91
2100100108	8" STİLSON YED.PAR.(ÇENE)	196
2100100110	10" STİLSON YED.PAR.(ÇENE)	196
2100100112	12" STİLSON YED.PAR.(ÇENE)	196
2100100114	14" STİLSON YED.PAR.(ÇENE)	196
2100100118	18" STİLSON YED.PAR.(ÇENE)	196
2100100124	24" STİLSON YED.PAR.(ÇENE)	196
2100100208	8" STİLSON BAĞLANTI ELEMANI	196
2100100210	10" STİLSON BAĞLANTI ELEMANI	196
2100100212	12" STİLSON BAĞLANTI ELEMANI	196
2100100214	14" STİLSON BAĞLANTI ELEMANI	196
2100100218	18" STİLSON BAĞLANTI ELEMANI	196
2100100224	24" STİLSON BAĞLANTI ELEMANI	196
2100100308	8" STİLSON YED.PAR.(SOMUN)	196
2100100310	10" STİLSON YED.PAR.(SOMUN)	196
2100100312	12" STİLSON YED.PAR.(SOMUN)	196
2100100314	14" STİLSON YED.PAR.(SOMUN)	196
2100100318	18" STİLSON YED.PAR.(SOMUN)	196
2100100324	24" STİLSON YED.PAR.(SOMUN)	196
2110100008	8" AĞIR TIP BORU ANAHTARI	91
2110100010	10" AĞIR TIP BORU ANAHTARI	91
2110100012	12" AĞIR TIP BORU ANAHTARI	91
2110100014	14" AĞIR TIP BORU ANAHTARI	91
2110100018	18" AĞIR TIP BORU ANAHTARI	91
2110100024	24" AĞIR TIP BORU ANAHTARI	91
2110100036	36" AĞIR TIP BORU ANAHTARI	91
2110100048	48" AĞIR TIP BORU ANAHTARI	91
2110100108	8" AĞIR TIP BORU ANAH.(ÇENE)	196
2110100110	10" AĞIR TIP BORU ANAH.(ÇENE)	196
2110100112	12" AĞIR TIP BORU ANAH.(ÇENE)	196
2110100114	14" AĞIR TIP BORU ANAH.(ÇENE)	196
2110100118	18" AĞIR TIP BORU ANAH.(ÇENE)	196
2110100124	24" AĞIR TIP BORU ANAH.(ÇENE)	196
2110100136	36" AĞIR TIP BORU ANAH.(ÇENE)	196
2110100148	48" AĞIR TIP BORU ANAH.(ÇENE)	196
2110100308	8" AĞIR TIP BORU ANAH.(SOMUN)	196
2110100310	10" AĞIR TIP BORU ANAH.(SOMUN)	196

KOD CODE	ÜRÜN İSMİ PRODUCT NAME	SAYFA NO PAGE NUMBER
2110100312	12" AĞIR TIP BORU ANAH.(SOMUN)	196
2110100314	14" AĞIR TIP BORU ANAH.(SOMUN)	196
2110100318	18" AĞIR TIP BORU ANAH.(SOMUN)	196
2110100324	24" AĞIR TIP BORU ANAH.(SOMUN)	196
2110100336	36" AĞIR TIP BORU ANAH.(SOMUN)	196
2110100348	48" AĞIR TIP BORU ANAH.(SOMUN)	196
2110100408	8" AĞIR TIP BORU ANAH. ALT ÇENE VE PİM	196
2110100410	10" AĞIR TIP BORU ANAH. ALT ÇENE VE PİM	196
2110100412	12" AĞIR TIP BORU ANAH. ALT ÇENE VE PİM	196
2110100414	14" AĞIR TIP BORU ANAH. ALT ÇENE VE PİM	196
2110100418	18" AĞIR TIP BORU ANAH. ALT ÇENE VE PİM	196
2110100424	24" AĞIR TIP BORU ANAH. ALT ÇENE VE PİM	196
2110100436	36" AĞIR TIP BORU ANAH. ALT ÇENE VE PİM	196
2110100448	48" AĞIR TIP BORU ANAH. ALT ÇENE VE PİM	196
2200100005	1/2" MAŞALI BORU ANAHTAR (45)	91
2200100010	1" MAŞALI BORU ANAHTAR (45)	91
2200100015	1 1/2" MAŞALI BORU ANAHTARI (45)	91
2200100020	2" MAŞALI BORU ANAHTARI (45)	91
2201100010	1" MAŞALI BORU ANAHTARI (85)	91
2201100015	1 1/2" MAŞALI BORU ANAHTARI (85)	91
2201100020	2" MAŞALI BORU ANAHTARI (85)	91
2201100030	3" MAŞALI BORU ANAHTARI (85)	91
2201100040	4" MAŞALI BORU ANAHTARI (85)	91
2201100110	1" MAŞALI YED.PAR. (SOMUN)	196
2201100115	1 1/2" MAŞALI YED.PAR. (SOMUN)	196
2201100120	2" MAŞALI YED.PAR. (SOMUN)	196
2201100130	3" MAŞALI YED.PAR. (SOMUN)	196
2201100140	4" MAŞALI YED.PAR. (SOMUN)	196
2202100010	1" İSVEÇ TİP MAŞALI BORU ANAHTAR	91
2202100015	1.5" İSVEÇ TİP MAŞALI BORU ANAHTAR	91
2202100020	2" İSVEÇ TİP MAŞALI BORU ANAHTAR	91
2203100010	1" ELTA MAŞALI BORU ANAHTARI	185
2203100015	1 1/2" ELTA MAŞALI BORU ANAHTARI	185
2203100020	2" ELTA MAŞALI BORU ANAHTARI	185
2203100030	3" ELTA MAŞALI BORU ANAHTARI	185
2300101015	1 1/2"(YEDEK PARÇA) ZİNCİR (300)	196
2300101120	12"(YEDEK PARÇA) ZİNCİR (1500)	196
2350006104	DEMİR KESME MAKASI SEHPASI (DOLU)	163
2350270018	18"(450) DEMİR KESME MAKASI	163
2350270024	24"(600) DEMİR KESME MAKASI	163
2350270030	30"(750) DEMİR KESME MAKASI	163
2350270036	36" (900) DEMİR KESME MAKASI	163
2350270118	18"(450) ÇENE	196
2350270124	24" (600) ÇENE	196
2350270130	30" (750) ÇENE	196
2350270136	36" (900) ÇENE	196
2350316104	DEMİR KESME MAKASI SEHPASI(BOŞ)	202
2400110160	160 MM UNIVERSAL FORT PENSE PVC	92
2400110240	240 MM ÜNİVERSAL FORT PENSE PVC	92
2400110315	315 MM UNIVERSAL FORT PEN.PVC	92
2400116240	240 MM ÜNİVERSAL FORT PENSE ELEKTRİKÇİ İZOLELİ 1000 V	92
2401110240	240 MM ELTA FORT PENSE KANALLI	185
2415110240	240 MM YAYLI FORT PENSE	92

KOD CODE	ÜRÜN İSMİ PRODUCT NAME	SAYFA NO PAGE NUMBER
2500110250	250 MM ÜNİVERSAL AYARLI PENSE	93
2505110250	250 MM STANDART AYARLI PENSE	93
2509110225	225 MM ELTA AYARLI PENSE	185
2510110250	250 MM SPECIAL AYARLI PENSE	93
2511110280	280 MM C TİPİ AYARLI PENSE	93
2512110200	200MM KAYNAKÇI AYARLI PENSE (DÜZ AĞIZ)	94
2513110280	280 MM KAYNAKÇI AYARLI PENSE (BORU İÇİN)	94
2515110270	270 MM KAPORTACI AYARLI PENSE	94
3020122160	160 MM KOMBİNE PENSE OPAK	95
3020122180	180 MM KOMBİNE PENSE OPAK	95
3020122200	200 MM KOMBİNE PENSE OPAK	95
3020123160	160 MM KOMBİNE PENSE KRAFT	95
3020123180	180 MM KOMBİNE PENSE KRAFT	95
3020123200	200 MM KOMBİNE PENSE KRAFT	95
3020125160	160 MM KOMBİNE PENSE ERGONOMİK	95
3020125180	180 MM KOMBİNE PENSE ERGONOMİK	95
3020125200	200 MM KOMBİNE PENSE ERGONOMİK	95
3020126160	160 MM KOMBİNE PENSE ELEKTRİKÇİ İZOLELİ 1000 V	95
3020126180	180 MM KOMBİNE PENSE ELEKTRİKÇİ İZOLELİ 1000 V	95
3020126200	200 MM KOMBİNE PENSE ELEKTRİKÇİ İZOLELİ 1000 V	95
3021121160	160 MM ELTA OPAK KOMBİNE PENSE	186
3021121180	180 MM ELTA OPAK KOMBİNE PENSE	186
3021121200	200 MM ELTA OPAK KOMBİNE PENSE	186
3030122180	180 MM KOMBİNE PENSE AĞIR TİP (ÇELİK TEL İÇİN)	95
3030122200	200 MM KOMBİNE PENSE AĞIR TİP (ÇELİK TEL İÇİN)	95
3220132140	140 MM UZUN KARGABURUN DÜZ UÇLU OPAK	96
3220132160	160 MM UZUN KARGABURUN DÜZ UÇLU OPAK	96
3220132180	180 MM UZUN KARGABURUN DÜZ UÇLU OPAK	96
3220132200	200 MM UZUN KARGABURUN DÜZ UÇLU OPAK	96
3220133140	140 MM UZUN KARGABURUN DÜZ UÇLU KRAFT	96
3220133160	160 MM UZUN KARGABURUN DÜZ UÇLU KRAFT	96
3220133180	180 MM UZUN KARGABURUN DÜZ UÇLU KRAFT	96
3220133200	200 MM UZUN KARGABURUN DÜZ UÇLU KRAFT	96
3220135140	140 MM UZUN KARGABURUN DÜZ UÇLU ERGONOMİK	96
3220135160	160 MM UZUN KARGABURUN DÜZ UÇLU ERGONOMİK	96
3220135180	180 MM UZUN KARGABURUN DÜZ UÇLU ERGONOMİK	96
3220135200	200 MM UZUN KARGABURUN DÜZ UÇLU ERGONOMİK	96
3220136140	140 MM UZUN DÜZ KARGABURUN ELEKTRİKÇİ İZOLELİ 1000 V	96
3220136160	160 MM UZUN DÜZ KARGABURUN ELEKTRİKÇİ İZOLELİ 1000 V	96
3220136180	180 MM UZUN DÜZ KARGABURUN ELEKTRİKÇİ İZOLELİ 1000 V	96
3220136200	200 MM UZUN DÜZ KARGABURUN ELEKTRİKÇİ İZOLELİ 1000 V	96
3221131160	160 MM ELTA OPAK KARGABURUN DÜZ	186
3221131200	200 MM ELTA OPAK KARGABURUN DÜZ	186
3225132160	160 MM UZUN KARGABURUN EĞRİ UÇLU OPAK	97
3225132180	180 MM UZUN KARGABURUN EĞRİ UÇLU OPAK	97
3225132200	200 MM UZUN KARGABURUN EĞRİ UÇLU OPAK	97
3225133160	160 MM UZUN KARGABURUN EĞRİ UÇLU KRAFT	97
3225133180	180 MM UZUN KARGABURUN EĞRİ UÇLU KRAFT	97
3225133200	200 MM UZUN KARGABURUN EĞRİ UÇLU KRAFT	97
3301120140	140 MM DIŞ SEGMAN PENSİ YAYLI DÜZ	101
3301120180	180 MM DIŞ SEGMAN PENSİ YAYLI DÜZ	101
3301120225	225 MM DIŞ SEGMAN PENSİ YAYLI DÜZ	101
3301120295	295 MM DIŞ SEGMAN PENSİ YAYLI DÜZ	101
3303120140	140 MM ELTA DIŞ DÜZ SEGMAN PENSE	186

KOD CODE	ÜRÜN İSMİ PRODUCT NAME	SAYFA NO PAGE NUMBER	KOD CODE	ÜRÜN İSMİ PRODUCT NAME	SAYFA NO PAGE NUMBER	KOD CODE	ÜRÜN İSMİ PRODUCT NAME	SAYFA NO PAGE NUMBER
3303120180	180 MM ELTA DIŞ DÜZ SEGMAN PENSE	186	3701161140	140 MM ELTA OPAK YAN KESKİ	186	4100179200	9x200 KRAFT TORNAVIDA DÜZ	120
3303120220	220 MM ELTA DIŞ DÜZ SEGMAN PENSE	186	3701161160	160 MM ELTA OPAK YAN KESKİ	186	4101172575	2.5X75 SÜNGÜSÜ İZOLELİ DÜZ TORNAVIDA	123
3304120125	125 MM ELTA DIŞ EĞRİ SEGMAN PENSE	186	3705165160	160 MM İNCE UÇLU YAN KESKİ	100	4101174100	4x100 SÜNGÜSÜ İZOLELİ DÜZ TORNAVIDA	123
3304120200	200 MM ELTA DIŞ EĞRİ SEGMAN PENSE	186	3715160165	TEK AĞIZLI KABLO KESİCİ 165MM	103	4101175512	5.5x125 SÜNGÜSÜ İZOLELİ DÜZ TORNAVIDA	123
3310120170	170 MM ÇAKMA UÇLU DIŞ SEGMAN PENSE EĞRİ	101	3715166165	1000V İZOLELİ TEK AĞIZLI KABLO KESİCİ 165MM	103	4101176515	6.5x150 SÜNGÜSÜ İZOLELİ DÜZ TORNAVIDA	123
3311120125	125 MM DIŞ SEGMAN PENSİ YAYLI EĞRİ	101	3720160220	220 MM ÇİFT AĞIZLI KABLO KESİCİ	104	4110170425	4X25 KRAFT DÜZ TOPAÇ TORNAVIDA	122
3311120170	170 MM DIŞ SEGMAN PENSİ YAYLI EĞRİ	101	3730162160	160 MM YAN KESKİ AĞIR TİP (ÇELİK TEL İÇİN)	100	4110170825	8X25 KRAFT DÜZ TOPAÇ TORNAVIDA	122
3311120210	210 MM DIŞ SEGMAN PENSİ YAYLI EĞRİ	101	3730162200	200 MM YAN KESKİ AĞIR TİP (ÇELİK TEL İÇİN)	100	4110175525	5.5X25 KRAFT DÜZ TOPAÇ TORNAVIDA	122
3311120275	275 MM DIŞ SEGMAN PENSİ YAYLI EĞRİ	101	3800150160	160 MM KERPETEN PVC KAPLI	107	4110175540	5.5x40 KRAFT DÜZ TOPAÇ TORNAVIDA	122
3320120140	140 MM ÇAKMA UÇLU İÇ SEGMAN PENSE DÜZ	101	3800150180	180 MM KERPETEN PVC KAPLI	107	4110176525	6.5X25 KRAFT DÜZ TOPAÇ TORNAVIDA	122
3320120225	225 MM ÇAKMA UÇLU İÇ SEGMAN PENSE DÜZ	101	3800150200	200 MM KERPETEN PVC KAPLI	107	4110176540	6.5X40 KRAFT DÜZ TOPAÇ TORNAVIDA	122
3321120140	140 MM İÇ SEGMAN PENSE YAYSIZ DÜZ	101	3800150250	250 MM KERPETEN PVC KAPLI	107	4120008106	6 LI KRAFT YILDIZ TORN.SETİ	121
3321120180	180 MM İÇ SEGMAN PENSE YAYSIZ DÜZ	101	3801150160	160 MM ELTA KERPETEN	187	4120180360	3x60 KRAFT YILDIZ TORNAVIDA	121
3321120225	225 MM İÇ SEGMAN PENSE YAYSIZ DÜZ	101	3801150180	180 MM ELTA KERPETEN	187	4120181200	10x200 KRAFT YILDIZ TORNAVIDA	121
3321120310	310 MM İÇ SEGMAN PENSE YAYSIZ DÜZ	101	3801150200	200 MM ELTA KERPETEN	187	4120184580	4,5x80 KRAFT YILDIZ TORNAVIDA	121
3323120140	140 MM ELTA İÇ DÜZ SEGMAN PENSE	186	3830150225	225 MM BETONCU KERPETEN PVC	107	4120185100	4.5x100 KRAFT YILDIZ TORNAVIDA	121
3323120180	180 MM ELTA İÇ DÜZ SEGMAN PENSE	186	3830150250	250 MM BETONCU KERPETEN PVC	107	4120185150	4.5x150 KRAFT YILDIZ TORNAVIDA	121
3323120230	230 MM ELTA İÇ DÜZ SEGMAN PENSE	186	3830150280	280 MM BETONCU KERPETEN PVC	107	4120185300	4.5x300 KRAFT YILDIZ TORNAVIDA	121
3324120130	130 MM ELTA İÇ EĞRİ SEGMAN PENSE	187	3831150280	280 MM BETONCU KERPETEN YAYLI	107	4120186100	6x100 KRAFT YILDIZ TORNAVIDA	121
3324120170	170 MM ELTA İÇ EĞRİ SEGMAN PENSE	187	3832150225	225 MM ELTA BETONCU KERPETENİ	187	4120186150	6X150 KRAFT YILDIZ TORNAVIDA	121
3324120210	210 MM ELTA İÇ EĞRİ SEGMAN PENSE	187	3832150250	250 MM ELTA BETONCU KERPETENİ	187	4120186200	6x200 KRAFT YILDIZ TORNAVIDA	121
3331120130	130 MM İÇ SEGMAN PENSE YAYSIZ EĞRİ	101	3832150280	280 MM ELTA BETONCU KERPETENİ	187	4120186300	6x300 KRAFT YILDIZ TORNAVIDA	121
3331120170	170 MM İÇ SEGMAN PENSE YAYSIZ EĞRİ	101	3835150280	280 MM AĞIR TİP BETONCU KERPETEN PVC	107	4120188150	8x150 KRAFT YILDIZ TORNAVIDA	121
3331120210	210 MM İÇ SEGMAN PENSE YAYSIZ EĞRİ	101	3850120200	200 MM DANALYA	107	4121180360	3x60 SÜNGÜSÜ İZOL.YILDIZ TORN.	123
3331120290	290 MM İÇ SEGMAN PENSE YAYSIZ EĞRİ	101	3852240225	225 MM DELİK ZIMBA	102	4121184580	4,5x80 SÜNGÜSÜ İZOL.YILDIZ TORN.	123
3400120275	275 MM SÜBAP SEGMAN PENSE	102	3860260180	180 MM TESTERE ÇAPRAZI	104	4121186100	6x100 SÜNGÜSÜ İZOLELİ YILDIZ TORN.	123
3405120225	265 PİSTON SEGMAN PENSE	102	4100008107	7 PARCALI KRAFT TORNAVIDA SETİ	121	4130180625	6x25 KRAFT YILDIZ TOPAÇ TORNAVIDA	122
3415120320	320 MM FREN YAY PENSESİ	102	4100008108	8 Lİ KRAFT DÜZ TORNAVIDA SERİSİ	120	4130180640	6x40 KRAFT YILDIZ TOPAÇ TORNAVIDA	122
3415120525	525 MM FREN YAY PENSESİ	102	4100170340	3x40 KRAFT TORNAVIDA DÜZ	120	4130184525	4.5X25 KRAFT YILDIZ TOPAÇ TORNAVIDA	122
3420120220	220 MM HORTUM KELEPÇE PENSE	102	4100170380	3x80 KRAFT TORNAVIDA DÜZ	120	4130184540	4.5x40 KRAFT YILDIZ TOPAÇ TORNAVIDA	122
3425120220	235 MM HORTUM KELEPÇE PNS. (SIKIŞTIRMA TİPİ)	102	4100170480	4x80 KRAFT TORNAVIDA DÜZ	120	4140009106	1000V ELEKTRİKÇİ İZOLE TORNAVIDA SET 6 PARÇA	123
3550140125	125 MM ELEKTRONİKÇİ YAN KESKİ	105	4100170580	5x80 KRAFT TORNAVIDA DÜZ	120	4140172575	2.5X75 ELEKTRİKÇİ İZOLELİ DÜZ TORNAVIDA 1000 V	123
3551140125	125 MM ELEKTRONİKÇİ TEPE KESKİ	105	4100171125	11x250 KRAFT TORNAVIDA DÜZ	120	4140174100	4x100 ELEKTRİKÇİ İZOLELİ DÜZ TORNAVIDA 1000 V	123
3552140125	125 MM ELEKTRONİKÇİ YUVARLAK UÇ KARGABURUN	105	4100174100	4x100 KRAFT TORNAVIDA DÜZ	120	4140175512	5.5x125 ELEKTRİKÇİ İZOLELİ DÜZ TORNAVIDA 1000 V	123
3553140150	150 MM ELEKTRONİKÇİ DÜZ UÇLU KARGABURUN	105	4100174250	4x250 KRAFT TORNAVIDA DÜZ	120	4140176515	6.5x150 ELEKTRİKÇİ İZOLELİ DÜZ TORNAVIDA 1000 V	123
3554140150	150 MM ELEKTRONİKÇİ UZUN KARGABURUN	105	4100174300	4x300 KRAFT TORNAVIDA DÜZ	120	4145180360	3x60 ELEKTRİKÇİ İZOLELİ YILDIZ TORNAVIDA 1000 V	123
3555140150	150 MM ELEKTRONİKÇİ SIVRI UÇ DÜZ KARGABURUN	105	4100175100	5x100 KRAFT TORNAVIDA DÜZ	120	4145184580	4,5x80 ELEKTRİKÇİ İZOLELİ YILDIZ TORN. 1000 V	123
3556140150	150 MM ELEKTRONİKÇİ SIVRI UÇ EĞRİ KARGABURUN	106	4100175125	5x125 KRAFT TORNAVIDA DÜZ	120	4145186100	6x100 ELEKTRİKÇİ İZOLELİ YILDIZ TORN. 1000 V	123
3557140125	125 MM ELEKTRONİKÇİ PENSE	106	4100175150	5x150 KRAFT TORNAVIDA DÜZ	120	4150008106	6 PARÇA ELTA TORNAVIDA SET OPAK	188
3560002104	4 PARÇA ELEKTRONİKÇİ KESKİ VE PENSE SETİ	106	4100175250	5x250 KRAFT TORNAVIDA DÜZ	120	4150008107	7'Lİ ELTA TORNAVIDA TAKIMI OPAK	188
3565002104	4 PARÇA ELEKTRONİKÇİ KARGABURUN SETİ	106	4100175300	5x300 KRAFT TORNAVIDA DÜZ	120	4150170380	3X80 ELTA DÜZ TORNAVIDA OPAK	187
3700162140	140 MM YAN KESKİ OPAK	98	4100175350	5x350 KRAFT TORNAVIDA DÜZ	120	4150170480	4x80 ELTA DÜZ TORNAVIDA OPAK	187
3700162160	160 MM YAN KESKİ OPAK	98	4100176100	6x100 KRAFT TORNAVIDA DÜZ	120	4150174100	4X100 ELTA DÜZ TORNAVIDA OPAK	187
3700162180	180 MM YAN KESKİ OPAK	98	4100176125	6x125 KRAFT TORNAVIDA DÜZ	120	4150175100	5x100 ELTA DÜZ TORNAVIDA OPAK	187
3700163140	140 MM YAN KESKİ KRAFT	98	4100176150	6x150 KRAFT TORNAVIDA DÜZ	120	4150175125	5X125 ELTA DÜZ TORNAVIDA OPAK	187
3700163160	160 MM YAN KESKİ KRAFT	98	4100176175	6x175 KRAFT TORNAVIDA DÜZ	120	4150176100	6X100 ELTA DÜZ TORNAVIDA OPAK	187
3700163180	180 MM YAN KESKİ KRAFT	98	4100176350	6x350 KRAFT TORNAVIDA DÜZ	120	4150176125	6x125 ELTA DÜZ TORNAVIDA OPAK	187
3700165140	140 MM YAN KESKİ ERGONOMİK	98	4100177125	7x125 KRAFT TORNAVIDA DÜZ	120	4150176150	6X150 ELTA DÜZ TORNAVIDA OPAK	187
3700165160	160 MM YAN KESKİ ERGONOMİK	98	4100177150	7x150 KRAFT TORNAVIDA DÜZ	120	4150177125	7X125 ELTA DÜZ TORNAVIDA OPAK	187
3700165180	180 MM YAN KESKİ ERGONOMİK	98	4100177175	7x175 KRAFT TORNAVIDA DÜZ	120	4150177150	7x150 ELTA DÜZ TORNAVIDA OPAK	187
3700166140	140 MM YAN KESKİ ELEKTRİKÇİ İZOLELİ 1000 V	98	4100178150	8x150 KRAFT TORNAVIDA DÜZ	120	4150178150	8X150 ELTA DÜZ TORNAVIDA OPAK	187
3700166160	160 MM YAN KESKİ ELEKTRİKÇİ İZOLELİ 1000 V	98	4100178175	8x175 KRAFT TORNAVIDA DÜZ	120	4150178175	8x175 ELTA DÜZ TORNAVIDA OPAK	187
3700166180	180 MM YAN KESKİ ELEKTRİKÇİ İZOLELİ 1000 V	98	4100178200	8x200 KRAFT TORNAVIDA DÜZ	120	4160170380	3X80 ELTA DÜZ TORNAVIDA ERGONOM	188

KOD CODE	ÜRÜN İSMİ PRODUCT NAME	SAYFA NO PAGE NUMBER	KOD CODE	ÜRÜN İSMİ PRODUCT NAME	SAYFA NO PAGE NUMBER	KOD CODE	ÜRÜN İSMİ PRODUCT NAME	SAYFA NO PAGE NUMBER
4160170480	4X80 ELTA DÜZ TORNAVİDA ERGONOM	188	4370185100	4.5x100 ERGONOMİK YILDIZ TORNAVİDA	125	4770190070	7 MM LOKMA UCLU TORNAVİDA	128
4160170580	5X80 ELTA DÜZ TORNAVİDA ERGONOM	188	4370185150	4.5x150 ERGONOMİK YILDIZ TORNAVİDA	125	4770190080	8 MM LOKMA UCLU TORNAVİDA	128
4160174100	4X100 ELTA DÜZ TORNAVİDA ERGONOM	188	4370186100	6x100 ERGONOMİK YILDIZ TORNAVİDA	125	4770190090	9 MM LOKMA UCLU TORNAVİDA	128
4160175100	5X100 ELTA DÜZ TORNAVİDA ERGONOM	188	4370186150	6x150 ERGONOMİK YILDIZ TORNAVİDA	125	4770190100	10 MM LOKMA UCLU TORNAVİDA	128
4160175125	5X125 ELTA DÜZ TORNAVİDA ERGONOM	188	4370188150	8x150 ERGONOMİK YILDIZ TORNAVİDA	125	4770190110	11 MM LOKMA UCLU TORNAVİDA	128
4160176150	6X150 ELTA DÜZ TORNAVİDA ERGONOM	188	4500008106	6 LI KLEMENS TORNAVİDA TK.	126	4770190120	12 MM LOKMA UCLU TORNAVİDA	128
4160177150	7X150 ELTA DÜZ TORNAVİDA ERGONOM	188	4500170380	3X80 KLEMENS DUZ TORNAVİDA	126	4770190130	13 MM LOKMA UCLU TORNAVİDA	128
4170170680	6X80 DEĞİŞKEN UCLU ELTA TORNAVİDA	189	4500170480	4X80 KLEMENS DUZ TORNAVİDA	126	4770190140	14 MM LOKMA UCLU TORNAVİDA	128
4170180360	3X60 ELTA YILDIZ TORNAVİDA OPAK	187	4500172560	2.5X60 KLEMENS DUZ TORNAVİDA	126	4771190090	9 MM ELTA LOKMA UÇLU TORNAVİDA	189
4170184580	4,5x80 ELTA YILDIZ TORNAVİDA OPAK	187	4500172580	2.5X80 KLEMENS DUZ TORNAVİDA	126	4771190110	11 MM ELTA LOKMA UÇLU TORNAVİDA	189
4170186100	6x100 ELTA YILDIZ TORNAVİDA OPAK	187	4500173100	3X100 KLEMENS DUZ TORNAVİDA	126	4772190040	4 MM SÜNGÜSÜ İZOLELİ LOKMA UCLU TORNAVİDA	128
4170188150	8X150 ELTA YILDIZ TORNAVİDA OPAK	187	4500173125	3X125 KLEMENS DUZ TORNAVİDA	126	4772190050	5 MM SÜNGÜSÜ İZOLELİ LOKMA UCLU TORNAVİDA	128
4180180360	3X60 ELTA YILDIZ TORNAVİDA ERGONOM	188	4500173510	3.5X100 KLEMENS DUZ TORNAVİDA	126	4772190060	6 MM SÜNGÜSÜ İZOLELİ LOKMA UCLU TORNAVİDA	128
4180184510	4.5X100 ELTA YILDIZ TORNAVİDA ERGONOM	188	4500174100	4X100 KLEMENS DUZ TORNAVİDA	126	4772190070	7 MM SÜNGÜSÜ İZOLELİ LOKMA UCLU TORNAVİDA	128
4180188150	8X150 ELTA YILDIZ TORNAVİDA ERGONOM	188	4500174125	4X125 KLEMENS DUZ TORNAVİDA	126	4772190080	8 MM SÜNGÜSÜ İZOLELİ LOKMA UCLU TORNAVİDA	128
4240007102	DEĞİŞKEN UCLU TORNAVİDA TAKIMI	126	4500174150	4X150 KLEMENS DUZ TORNAVİDA	126	4772190090	9 MM SÜNGÜSÜ İZOLELİ LOKMA UCLU TORNAVİDA	128
4240170680	6X80 DEĞİŞKEN UCLU TORNAVİDA	126	4501173150	ELTA ELEKTRONİKÇİ TİP KLM. DÜZ UÇLU TORNAVİDA 3X150	189	4772190100	10 MM SÜNGÜSÜ İZOLELİ LOKMA UCLU TORNAVİDA	128
4300008107	7 PARCALI OPAK TORNAVİDA SETİ	124	4501174150	4X150 ELTA KLEMENS DÜZ TORNAVİDA	189	4772190110	11 MM SÜNGÜSÜ İZOLELİ LOKMA UCLU TORNAVİDA	128
4300170380	3x80 OPAK DUZ TORNAVİDA	124	4520180360	3X60 KLEMENS YILDIZ TORNAVİDA	126	4772190120	12 MM SÜNGÜSÜ İZOLELİ LOKMA UCLU TORNAVİDA	128
4300170480	4x80 OPAK DUZ TORNAVİDA	124	4520180480	4X80 KLEMENS YILDIZ TORNAVİDA	126	4772190130	13 MM SÜNGÜSÜ İZOLELİ LOKMA UCLU TORNAVİDA	128
4300174100	4X100 OPAK DUZ TORNAVİDA	124	4520184150	4X150 KLEMENS YILDIZ TORNAVİDA	126	4772190140	14 MM SÜNGÜSÜ İZOLELİ LOKMA UCLU TORNAVİDA	128
4300175100	5x100 OPAK DUZ TORNAVİDA	124	4530001006	6'LI TORX UÇLU KLEMENS TORNAVİDA TAKIMI	127	4773008108	1000V SÜNGÜSÜ İZ. LOKMA UÇLU TORNAVİDA SET 8 PARÇA	129
4300175125	5x125 OPAK DUZ TORNAVİDA	124	4530170560	T5X60 TORX UÇLU KLEMENS TORNAVİDA	127	4773190040	1000V SÜNGÜSÜ İZ. LOKMA UÇLU TORNAVİDA 4 MM	129
4300176100	6x100 OPAK DUZ TORNAVİDA	124	4530170660	T6X60 TORX UÇLU KLEMENS TORNAVİDA	127	4773190050	1000V SÜNGÜSÜ İZ. LOKMA UÇLU TORNAVİDA 5 MM	129
4300176125	6x125 OPAK DUZ TORNAVİDA	124	4530170760	T7X60 TORX UÇLU KLEMENS TORNAVİDA	127	4773190055	1000V SÜNGÜSÜ İZ. LOKMA UÇLU TORNAVİDA 5.5 MM	129
4300176150	6x150 OPAK DUZ TORNAVİDA	124	4530170860	T8X60 TORX UÇLU KLEMENS TORNAVİDA	127	4773190060	1000V SÜNGÜSÜ İZOLELİ LOKMA UÇLU TORNAVİDA 6MM	129
4300177125	7x125 OPAK DUZ TORNAVİDA	124	4530170960	T9X60 TORX UÇLU KLEMENS TORNAVİDA	127	4773190070	1000V SÜNGÜSÜ İZOLELİ LOKMA UÇLU TORNAVİDA 7MM	129
4300177150	7x150 OPAK DUZ TORNAVİDA	124	4530171060	T10X60 TORX UÇLU KLEMENS TORNAVİDA	127	4773190080	1000V SÜNGÜSÜ İZOLELİ LOKMA UÇLU TORNAVİDA 8MM	129
4300178175	8x175 OPAK DUZ TORNAVİDA	124	4540190190	KLİPS SÖKME TORNAVİDA	127	4773190090	1000V SÜNGÜSÜ İZOLELİ LOKMA UÇLU TRN. 9MM	129
4300179200	9x200 OPAK DÜZ TORNAVİDA	124	4550170135	135 MM KONTROL KALEMİ	119	4773190100	1000V SÜNGÜSÜ İZOLELİ LOKMA UÇLU TRN. 10MM	129
4320180360	3x60 OPAK YILDIZ TORNAVİDA	124	4550170190	190 MM KONTROL KALEMİ	119	4773190110	1000V SÜNGÜSÜ İZOLELİ LOKMA UÇLU TRN. 11MM	129
4320184580	4,5X80 OPAK YILDIZ TORNAVİDA	124	4552170190	190 MM ELTA KONTROL KALEMİ	189	4773190120	1000V SÜNGÜSÜ İZOLELİ LOKMA UÇLU TRN. 12MM	129
4320186100	6x100 OPAK YILDIZ TORNAVİDA	124	4555170165	165 MM MASTER KONTROL KALEMİ	119	4773190130	1000V SÜNGÜSÜ İZOLELİ LOKMA UÇLU TRN. 13MM	129
4320188150	8x150 OPAK YILDIZ TORNAVİDA	124	4560180135	135 MM YILDIZ KONTROL KALEMİ	119	4773190140	1000V SÜNGÜSÜ İZOLELİ LOKMA UÇLU TRN. 14 MM	129
4325180360	3x60 POZİDRİV YILDIZ TORNAVİDA	124	4560180190	190 MM YILDIZ KONTROL KALEMİ	119	4775008107	7'LI TORX UÇLU TORNAVİDA TAKIMI	129
4325184580	4,5x80 POZİDRİV YILDIZ TORNAVİDA	124	4565170135	135 MM OTO ELEKTRİK KONTROL KALEMİ	119	4775180010	T 10 MM TORX UCLU TORNAVİDA	129
4325186100	6X100 POZİDRİV YILDIZ TORNAVİDA	124	4765190040	4 MM T TİPİ LOKMA UCLU TORNAVİDA	128	4775180015	T 15 MM TORX UCLU TORNAVİDA	129
4325188150	8X150 POZİDRİV YILDIZ TORNAVİDA	124	4765190050	5 MM T TİPİ LOKMA UCLU TORNAVİDA	128	4775180020	T 20 MM TORX UCLU TORNAVİDA	129
4350008107	7 PARCALI ERGONOMİK TORNAVİDA SETİ	125	4765190055	5,5 MM T TİPİ LOKMA UCLU TORNAVİDA	128	4775180025	T 25 MM TORX UCLU TORNAVİDA	129
4350170380	3x80 ERGONOMİK DUZ TORNAVİDA	125	4765190060	6 MM T TİPİ LOKMA UCLU TORNAVİDA	128	4775180027	T 27 MM TORX UCLU TORNAVİDA	129
4350170480	4x80 ERGONOMİK DUZ TORNAVİDA	125	4765190070	7 MM T TİPİ LOKMA UCLU TORNAVİDA	128	4775180030	T 30 MM TORX UCLU TORNAVİDA	129
4350174100	4x100 ERGONOMİK DUZ TORNAVİDA	125	4765190080	8 MM T TİPİ LOKMA UCLU TORNAVİDA	128	4775180040	T 40 MM TORX UCLU TORNAVİDA	129
4350175100	5x100 ERGONOMİK DUZ TORNAVİDA	125	4765190090	9 MM T TİPİ LOKMA UCLU TORNAVİDA	128	4775180045	T 45 MM TORX UCLU TORNAVİDA	129
4350175125	5x125 ERGONOMİK DUZ TORNAVİDA	125	4765190100	10 MM T TİPİ LOKMA UCLU TORNAVİDA	128	4776008107	7'LI DELİKLİ TORX TORNAVİDA SETİ	130
4350176100	6x100 ERGONOMİK DUZ TORNAVİDA	125	4765190110	11 MM T TİPİ LOKMA UCLU TORNAVİDA	128	4776180009	TR 09 DELİKLİ TORX UÇLU TORNAVİDA	130
4350176125	6x125 ERGONOMİK DUZ TORNAVİDA	125	4765190120	12 MM T TİPİ LOKMA UCLU TORNAVİDA	128	4776180010	TR 10 DELİKLİ TORX UÇLU TORNAVİDA	130
4350176150	6x150 ERGONOMİK DUZ TORNAVİDA	125	4765190130	13 MM T TİPİ LOKMA UCLU TORNAVİDA	128	4776180015	TR 15 DELİKLİ TORX UÇLU TORNAVİDA	130
4350177125	7x125 ERGONOMİK DUZ TORNAVİDA	125	4765190140	14 MM T TİPİ LOKMA UCLU TORNAVİDA	128	4776180020	TR 20 DELİKLİ TORX UÇLU TORNAVİDA	130
4350177150	7x150 ERGONOMİK DUZ TORNAVİDA	125	4770008108	8'LI LOKMA UÇLU TORNAVİDA SETİ	128	4776180025	TR 25 DELİKLİ TORX UÇLU TORNAVİDA	130
4350178175	8x175 ERGONOMİK DUZ TORNAVİDA	125	4770190040	4 MM LOKMA UCLU TORNAVİDA	128	4776180027	TR 27 DELİKLİ TORX UÇLU TORNAVİDA	130
4350179200	9x200 ERGONOMİK DUZ TORNAVİDA	125	4770190050	5 MM LOKMA UCLU TORNAVİDA	128	4776180030	TR 30 DELİKLİ TORX UÇLU TORNAVİDA	130
4370180360	3x60 ERGONOMİK YILDIZ TORNAVİDA	125	4770190055	5,5 MM LOKMA UCLU TORNAVİDA	128	4776180040	TR 40 DELİKLİ TORX UÇLU TORNAVİDA	130
4370184580	4,5x80 ERGONOMİK YILDIZ TORNAVİDA	125	4770190060	6 MM LOKMA UCLU TORNAVİDA	128	4780196120	6.3X120 MANYETİK BİTS TUTUCU TOR.	130

KOD CODE	ÜRÜN İSMİ PRODUCT NAME	SAYFA NO PAGE NUMBER
4783196120	6.3X120 ELEKTRİKÇİ İZ. MANYETİK BİTS TUTUCU TOR. 1000 V	130
4785196330	6.3X30 MANYETİK BİTS TUTUCU KISA	130
4788196160	6.3X160 FLEXİBLE SÜNGÜLÜ MANYETİK BİTS TUTUCU TRNV.	131
4790266360	6.3X60 UNIVERSAL BITS ADAPTORU	130
4795190010	6.3X130 T TİPİ MANYETİK BİTS TUTUCU	131
4800008106	6 LI BITS SET (25 MM)	131
4800008110	10 LU BITS SET (25 MM)	131
4800008131	31 LI BITS TAKIM (PLASTİK KUTULU)	131
4805205010	1/4"M - 1/4"M BİTS UÇ LK A 50MM	131
4805205011	1/4"M - 1/2"M BİTS UÇ LOKMA ADP 50MM	131
4810000645	0.6X4.5 DUZ BITS UÇ SET	132
4810000855	0.8X5.5 DUZ BITS UÇ SET	132
4810001265	1.2X6.5 DUZ BITS UÇ SET	132
4810200645	0.6x4.5 DÜZ BITS UÇ (25 MM)	132
4810200855	0.8x5.5 DÜZ BITS UÇ (25 MM)	132
4810201265	1.2x6.5 DÜZ BITS UÇ (25 MM)	132
4810205265	1,2X6,5 DÜZ BITS UÇ (50MM)	132
4810205645	0,6X4,5 DÜZ BITS UÇ (50MM)	132
4810205855	0,8X5,5 DÜZ BITS UÇ (50MM)	132
4811200645	0.6x4.5 ELTA DÜZ BITS UÇ 25MM	189
4811200855	0.8x5.5 ELTA DÜZ BITS UÇ 25 MM	189
4811201265	1.2x6.5 ELTA DÜZ BITS UÇ 25 MM	189
4811205265	1,2X6,5 ELTA DÜZ BITS UÇ 50 MM	189
4811205645	0,6X4,5 ELTA DÜZ BITS UÇ 50MM	189
4811205855	0,8X5,5 ELTA DÜZ BITS UÇ 50MM	189
4815006107	DEĞİŞKEN BİTS UÇLU TORNAVIDA SET (7 Parça)	131
4820000001	PH1 YILDIZ BITS UÇ SET	132
4820000002	PH2 YILDIZ BITS UÇ SET	132
4820000003	PH3 YILDIZ BITS UÇ SET	132
4820210001	PH 1 YILDIZ BITS UÇ 25MM	132
4820210002	PH 2 YILDIZ BITS UÇ 25MM	132
4820210003	PH 3 YILDIZ BITS UÇ 25MM	132
4820210011	PH 1 YILDIZ BITS UÇ 50 MM	132
4820210012	PH 2 YILDIZ BITS UÇ 50MM	132
4820210013	PH 3 YILDIZ BITS UÇ 50 MM	132
4821210001	PH1 ELTA YILDIZ BITS UÇ 25 MM	189
4821210002	PH2 ELTA YILDIZ BITS UÇ 25MM	189
4821210003	PH3 ELTA YILDIZ BITS UÇ 25 MM	189
4821210011	PH1 ELTA YILDIZ BITS UÇ 50 MM	189
4821210013	PH3 ELTA YILDIZ BITS UÇ 50 MM	189
4825000001	Pz 1 POZİDRİV BİTS SET (25 MM)	133
4825000002	Pz 2 POZİDRİV BİTS SET (25 MM)	133
4825000003	Pz 3 POZİDRİV BİTS SET (25 MM)	133
4825210001	Pz 1 POZİDRİV BİTS UÇ 25MM	133
4825210002	Pz 2 POZİDRİV BİTS UÇ 25 MM	133
4825210003	Pz 3 POZİDRİV BİTS UÇ 25 MM	133
4825210011	PZ 1 POZİDRİV BİTS UÇ 50 MM	133
4825210012	PZ 2 POZİDRİV BİTS UÇ 50MM	133
4825210013	PZ 3 POZİDRİV BİTS UÇ 50 MM	133
4830000025	T 25 TORX BİTS UÇ (25 MM) SET	133
4830000027	T 27 TORX BİTS UÇ(25 MM) SET	133
4830000030	T 30 TORX BİTS UÇ(25 MM) SET	133
4830000040	T 40 TORX BİTS UÇ (25 MM) SET	133

KOD CODE	ÜRÜN İSMİ PRODUCT NAME	SAYFA NO PAGE NUMBER
4830210025	T 25 TORX BİTS UÇ (25MM)	133
4830210027	T 27 TORX BİTS UÇ (25MM)	133
4830210030	T 30 TORX BİTS UÇ (25MM)	133
4830210040	T 40 TORX BİTS UÇ (25MM)	133
4830210125	T 25 TORK BİTS UÇ 50MM	133
4830210127	T 27 TORX BİTS UÇ 50MM	133
4830210130	T 30 TORX BİTS UÇ 50MM	133
4830210140	T 40 TORX BİTS UÇ 50MM	133
4831210025	T25 ELTA TORKS BİTS UÇ (25 MM)	189
4831210027	T27 ELTA TORKS BİTS UÇ (25 MM)	189
4831210030	T30 ELTA TORKS BİTS UÇ (25 MM)	189
4831210040	T40 ELTA TORKS BİTS UÇ (25 MM)	189
4831210125	T25 ELTA TORKS BİTS UÇ 50 MM	189
4831210127	T27 ELTA TORKS BİTS UÇ 50 MM	189
4831210140	T40 ELTA TORKS BİTS UÇ 50 MM	189
4850000713	13'LÜ UZUN BİTS TAKIM (75 MM)	134
4850001013	13'LÜ UZUN BİTS TAKIM (100 MM)	134
4850001513	13'LÜ UZUN BİTS TAKIM (150 MM)	134
4860200745	4,5 MM UZUN DÜZ BITS UÇ (75 MM)	132
4860200755	5,5 MM UZUN DÜZ BITS UÇ (75 MM)	132
4860200765	6,5 MM UZUN DÜZ BITS UÇ (75 MM)	132
4860201045	4,5 MM UZUN DÜZ BITS UÇ (100 MM)	132
4860201055	5,5 MM UZUN DÜZ BITS UÇ (100 MM)	132
4860201065	6,5 MM UZUN DÜZ BITS UÇ (100 MM)	132
4860201545	4,5 MM UZUN DÜZ BITS UÇ (150 MM)	132
4860201555	5,5 MM UZUN DÜZ BITS UÇ (150 MM)	132
4860201565	6,5 MM UZUN DÜZ BITS UÇ (150 MM)	132
4870210701	PH 1 UZUN YILDIZ BİTS UÇ 75MM	132
4870210702	PH 2 UZUN YILDIZ BİTS UÇ 75MM	132
4870210703	PH 3 UZUN YILDIZ BİTS UÇ 75MM	132
4870211001	PH 1 UZUN YILDIZ BİTS UÇ 100 MM	132
4870211002	PH 2 UZUN YILDIZ BİTS UÇ 100 MM	132
4870211003	PH 3 UZUN YILDIZ BİTS UÇ 100 MM	132
4870211501	PH 1 UZUN YILDIZ BİTS UÇ 150 MM	132
4870211502	PH 2 UZUN YILDIZ BİTS UÇ 150 MM	132
4870211503	PH 3 UZUN YILDIZ BİTS UÇ 150 MM	132
4880210701	Pz 1 UZUN POZİDRİV BİTS UÇ 75MM	133
4880210702	Pz 2 UZUN POZİDRİV BİTS UÇ 75MM	133
4880210703	Pz 3 UZUN POZİDRİV BİTS UÇ 75MM	133
4880211001	Pz 1 UZUN POZİDRİV BİTS UÇ 100MM	133
4880211002	Pz 2 UZUN POZİDRİV BİTS UÇ 100MM	133
4880211003	Pz 3 UZUN POZİDRİV BİTS UÇ 100MM	133
4880211501	Pz 1 UZUN POZİDRİV BİTS UÇ 150MM	133
4880211502	Pz 2 UZUN POZİDRİV BİTS UÇ 150MM	133
4880211503	Pz 3 UZUN POZİDRİV BİTS UÇ 150MM	133
4885210725	T 25 UZUN TORX BİTS UÇ (75MM)	133
4885210727	T 27 UZUN TORX BİTS UÇ (75MM)	133
4885210730	T 30 UZUN TORX BİTS UÇ (75MM)	133
4885210740	T 40 UZUN TORX BİTS UÇ (75MM)	133
4885211025	T 25 UZUN TORX BİTS UÇ (100MM)	133
4885211027	T 27 UZUN TORX BİTS UÇ (100MM)	133
4885211030	T 30 UZUN TORX BİTS UÇ (100MM)	133
4885211040	T 40 UZUN TORX BİTS UÇ (100MM)	133

KOD CODE	ÜRÜN İSMİ PRODUCT NAME	SAYFA NO PAGE NUMBER
4885211525	T 25 UZUN TORX BİTS UÇ (150MM)	133
4885211527	T 27 UZUN TORX BİTS UÇ (150MM)	133
4885211530	T 30 UZUN TORX BİTS UÇ (150MM)	133
4885211540	T 40 UZUN TORX BİTS UÇ (150MM)	133
4900003110	10'LU ALLEN ANAH.TK.	135
4900003112	12'LI ALLEN ANAHTAR TAKIMI	135
4900220015	1,5 MM ALLEN ANAHTAR	135
4900220020	02 MM ALLEN ANAHTAR	135
4900220025	2,5 MM ALLEN ANAHTAR	135
4900220030	03 MM ALLEN ANAHTAR	135
4900220035	3,5 MM ALLEN ANAHTAR	135
4900220040	04 MM ALLEN ANAHTAR	135
4900220050	05 MM ALLEN ANAHTAR	135
4900220060	06 MM ALLEN ANAHTAR	135
4900220070	07 MM ALLEN ANAHTAR	135
4900220080	08 MM ALLEN ANAHTAR	135
4900220090	09 MM ALLEN ANAHTAR	135
4900220100	10 MM ALLEN ANAHTAR	135
4900220120	12 MM ALLEN ANAHTAR	135
4900220140	14 MM ALLEN ANAHTAR	135
4900220160	16 MM ALLEN ANAHTAR	135
4900220170	17 MM ALLEN ANAHTAR	135
4900220190	19 MM ALLEN ANAHTAR	135
4900220220	22 MM ALLEN ANAHTAR	135
4900220240	24 MM ALLEN ANAHTAR	135
4901003110	10 LU ALLEN ANT TK SAE	135
4901003112	12 LI ALLEN ANT TK SAE	135
4901221111	7/16 ALLEN SAE ANAHTAR	135
4901221270	1/2 ALLEN SAE ANAHTAR	135
4901221428	9/16 ALLEN SAE ANAHTAR	135
4901221587	5/8 ALLEN SAE ANAHTAR	135
4901221905	3/4 ALLEN SAE ANAHTAR	135
4901221984	5/64 ALLEN SAE ANAHTAR	135
4901222381	3/32 ALLEN SAE ANAHTAR	135
4901223125	1/8 ALLEN SAE ANAHTAR	135
4901223968	5/32 ALLEN SAE ANAHTAR	135
4901224762	3/16 ALLEN SAE ANAHTAR	135
4901225556	7/32 ALLEN SAE ANAHTAR	135
4901226350	1/4 ALLEN SAE ANAHTAR	135
4901227937	5/16 ALLEN SAE ANAHTAR	135
4901229825	3/8 ALLEN SAE ANAHTAR	135
4903003110	10 LU ALLEN AN.TK.UZUN BOY	136
4903003112	12 LI ALLEN AN.TK.UZUN BOY	136
4903220020	2 MM ALLEN ANAHTAR UZUN BOY	136
4903220025	2,5 MM ALLEN ANAHTAR UZUN BOY	136
4903220030	3 MM ALLEN ANAHTAR UZUN BOY	136
4903220035	3,5 MM ALLEN ANAHTAR UZUN BOY	136
4903220040	4 MM ALLEN ANAHTAR UZUN BOY	136
4903220050	5 MM ALLEN ANAHTAR UZUN BOY	136
4903220060	6 MM ALLEN ANAHTAR UZUN BOY	136
4903220070	7 MM ALLEN ANAHTAR UZUN BOY	136
4903220080	8 MM ALLEN ANAHTAR UZUN BOY	136
4903220090	9 MM ALLEN ANAHTAR UZUN BOY	136

KOD CODE	ÜRÜN İSMİ PRODUCT NAME	SAYFA NO PAGE NUMBER	KOD CODE	ÜRÜN İSMİ PRODUCT NAME	SAYFA NO PAGE NUMBER	KOD CODE	ÜRÜN İSMİ PRODUCT NAME	SAYFA NO PAGE NUMBER
4903220100	10 MM ALLEN ANAHTAR UZUN BOY	136	4910007108	8 Lİ TORX ALLEN TK.	137	4922220030	3 MM ELTA T TİPİ ALLEN ANAHTAR	191
4903220120	12 MM ALLEN ANAHTAR UZUN BOY	136	4910220006	T 6 TORX ALLEN	137	4922220040	4 MM ELTA T TİPİ ALLEN ANAHTAR	191
4903220140	14 MM ALLEN ANAHTAR UZUN BOY	136	4910220007	T 7 TORX ALLEN	137	4922220050	5 MM ELTA T TİPİ ALLEN ANAHTAR	191
4903220160	16 MM ALLEN ANAHTAR UZUN BOY	136	4910220008	T 8 TORX ALLEN	137	4922220060	6 MM ELTA T TİPİ ALLEN ANAHTAR	191
4903220170	17 MM ALLEN ANAHTAR UZUN BOY	136	4910220009	T 9 TORX ALLEN	137	4922220070	7 MM ELTA T TİPİ ALLEN ANAHTAR	191
4903220190	19 MM ALLEN ANAHTAR UZUN BOY	136	4910220010	T 10 TORX ALLEN	137	4922220080	8 MM ELTA T TİPİ ALLEN ANAHTAR	191
4905007108	8'Lİ ALLEN AN.TK.(BALLPOINT HEXAGON)	136	4910220015	T 15 TORX ALLEN	137	4922220100	10 MM ELTA T TİPİ ALLEN ANAHTAR	191
4905220020	2 MM ALLEN AN.(BALLPOINT HEXAGON)	136	4910220020	T 20 TORX ALLEN	137	5010008106	6 LI ISKARPELA TAKIMI	143
4905220025	2.5 MM ALLEN AN.(BALLPOINT HEXAGON)	136	4910220025	T 25 TORX ALLEN	137	5010230006	06 MM ISKARPELA DUZ	143
4905220030	3 MM ALLEN AN.(BALLPOINT HEXAGON)	136	4910220027	T 27 TORX ALLEN	137	5010230008	08 MM ISKARPELA DUZ	143
4905220040	4 MM ALLEN AN.(BALLPOINT HEXAGON)	136	4910220030	T 30 TORX ALLEN	137	5010230010	10 MM ISKARPELA DUZ	143
4905220050	5 MM ALLEN AN.(BALLPOINT HEXAGON)	136	4910220040	T 40 TORX ALLEN	137	5010230012	12 MM ISKARPELA DUZ	143
4905220060	6 MM ALLEN AN.(BALLPOINT HEXAGON)	136	4910220045	T 45 TORX ALLEN	137	5010230014	14 MM ISKARPELA DUZ	143
4905220080	8 MM ALLEN AN.(BALLPOINT HEXAGON)	136	4910220050	T 50 TORX ALLEN	137	5010230016	16 MM ISKARPELA DUZ	143
4905220100	10 MM ALLEN AN.(BALLPOINT HEXAGON)	136	4910220055	T 55 TORX ALLEN	137	5010230018	18 MM ISKARPELA DUZ	143
4906003109	9'LU YUVARLAK BAŞLI UZUN ALLEN TK.	137	4910220060	T 60 TORX ALLEN	137	5010230020	20 MM ISKARPELA DUZ	143
4906220015	1,5 MM YUVARLAK BAŞLI UZUN ALLEN	137	4911220006	T 6 ELTA TORX ALLEN	190	5010230022	22 MM ISKARPELA DUZ	143
4906220020	2 MM YUVARLAK BAŞLI UZUN ALLEN	137	4911220007	T 7 ELTA TORX ALLEN	190	5010230024	24 MM ISKARPELA DUZ	143
4906220025	2,5 MM YUVARLAK BAŞLI UZUN ALLEN	137	4911220008	T 8 ELTA TORX ALLEN	190	5010230026	26 MM ISKARPELA DUZ	143
4906220030	3 MM YUVARLAK BAŞLI UZUN ALLEN	137	4911220009	T 9 ELTA TORX ALLEN	190	5010230028	28 MM ISKARPELA DUZ	143
4906220040	4 MM YUVARLAK BAŞLI UZUN ALLEN	137	4911220015	T 15 ELTA TORX ALLEN	190	5010230030	30 MM ISKARPELA DUZ	143
4906220050	5 MM YUVARLAK BAŞLI UZUN ALLEN	137	4911220020	T 20 ELTA TORX ALLEN	190	5011230006	06 MM ELTA ISKARPELA	191
4906220060	6 MM YUVARLAK BAŞLI UZUN ALLEN	137	4911220025	T 25 ELTA TORX ALLEN	190	5011230008	08 MM ELTA ISKARPELA	191
4906220080	8 MM YUVARLAK BAŞLI UZUN ALLEN	137	4911220027	T 27 ELTA TORX ALLEN	190	5011230010	10 MM ELTA ISKARPELA	191
4906220100	10 MM YUVARLAK BAŞLI UZUN ALLEN	137	4911220030	T 30 ELTA TORX ALLEN	190	5011230012	12 MM ELTA ISKARPELA	191
4908003107	7' Lİ ELTA ALLEN ANAHTAR TAKIMI	190	4911220040	T 40 ELTA TORX ALLEN	190	5011230014	14 MM ELTA ISKARPELA	191
4908003109	9' LU ELTA ALLEN ANAHTAR TAKIMI	190	4911220045	T 45 ELTA TORX ALLEN	190	5011230016	16 MM ELTA ISKARPELA	191
4908003110	10' LU ELTA ALLEN ANAHTAR TAKIMI	190	4911220050	T 50 ELTA TORX ALLEN	190	5011230018	18 MM ELTA ISKARPELA	191
4908220015	1,5 MM ELTA ALLEN ANAHTAR	190	4911220055	T 55 ELTA TORX ALLEN	190	5011230020	20 MM ELTA ISKARPELA	191
4908220020	2 MM ELTA ALLEN ANAHTAR	190	4911220060	T 60 ELTA TORX ALLEN	190	5011230022	22 MM ELTA ISKARPELA	191
4908220025	2,5 MM ELTA ALLEN ANAHTAR	190	4912000007	* 7 Lİ (1,5-6) KASET ALLEN ANAHTAR TK.	138	5011230024	24 MM ELTA ISKARPELA	191
4908220030	3 MM ELTA ALLEN ANAHTAR	190	4912003107	* 7 Lİ (2,5-10) KASET ALLEN ANAHTAR TK.	138	5011230026	26 MM ELTA ISKARPELA	191
4908220035	3,5 MM ELTA ALLEN ANAHTAR	190	4915006106	6'Lİ ELTA KASET ALLEN ANAHTAR TK.	190	5011230028	28 MM ELTA ISKARPELA	191
4908220040	4 MM ELTA ALLEN ANAHTAR	190	4920008108	8'Lİ T TİPİ ALLEN ANAHTAR TK.	139	5011230030	30 MM ELTA ISKARPELA	191
4908220050	5 MM ELTA ALLEN ANAHTAR	190	4920220025	2,5 MM T TİPİ ALLEN ANAHTAR	139	5500230100	100 MM DÜZ KESKİ KROM	143
4908220060	6 MM ELTA ALLEN ANAHTAR	190	4920220030	3 MM T TİPİ ALLEN ANAHTAR	139	5500230125	125 MM DÜZ KESKİ KROM	143
4908220070	7 MM ELTA ALLEN ANAHTAR	190	4920220040	4 MM T TİPİ ALLEN ANAHTAR	139	5500230150	150 MM DÜZ KESKİ KROM	143
4908220080	8 MM ELTA ALLEN ANAHTAR	190	4920220050	5 MM T TİPİ ALLEN ANAHTAR	139	5500230175	175 MM DÜZ KESKİ KROM	143
4908220090	9 MM ELTA ALLEN ANAHTAR	190	4920220060	6 MM T TİPİ ALLEN ANAHTAR	139	5500230200	200 MM DÜZ KESKİ KROM	143
4908220100	10 MM ELTA ALLEN ANAHTAR	190	4920220070	7 MM T TİPİ ALLEN ANAHTAR	139	5500230250	250 MM DÜZ KESKİ KROM	143
4908220120	12 MM ELTA ALLEN ANAHTAR	190	4920220080	8 MM T TİPİ ALLEN ANAHTAR	139	5500230300	300 MM DÜZ KESKİ KROM	143
4908220140	14 MM ELTA ALLEN ANAHTAR	190	4920220100	10 MM T TİPİ ALLEN ANAHTAR	139	5500231250	250 MM DÜZ KESKİ KALKAN İZOLELİ	143
4908220170	17 MM ELTA ALLEN ANAHTAR	190	4921008108	8 Lİ T TİPİ YUV.BAŞL.ALLEN TK.	139	5500231300	300 MM DÜZ KESKİ KALKAN İZOLELİ	143
4908220190	19 MM ELTA ALLEN ANAHTAR	190	4921220025	2,5 MM T TİP YUVARLAK BAŞLI ALLEN	139	5501230100	100 MM ELTA DÜZ KESKİ	191
4909008108	8 PARÇA T TİPİ TORX ALLEN TAKIMI	138	4921220030	3 MM T TİP YUVARLAK BAŞLI ALLEN	139	5501230125	125 MM ELTA DÜZ KESKİ	191
4909220009	T 9 T TİPİ TORX ALLEN ANAHTAR	138	4921220040	4 MM T TİP YUVARLAK BAŞLI ALLEN	139	5501230150	150 MM ELTA DÜZ KESKİ	191
4909220010	T 10 T TİPİ TORX ALLEN ANAHTAR	138	4921220050	5 MM T TİP YUVARLAK BAŞLI ALLEN	139	5501230175	175 MM ELTA DÜZ KESKİ	191
4909220015	T 15 T TİPİ TORX ALLEN ANAHTAR	138	4921220060	6 MM T TİP YUVARLAK BAŞLI ALLEN	139	5501230200	200 MM ELTA DÜZ KESKİ	191
4909220020	T 20 T TİPİ TORX ALLEN ANAHTAR	138	4921220070	7 MM T TİP YUVARLAK BAŞLI ALLEN	139	5501230250	250 MM ELTA DÜZ KESKİ	191
4909220025	T 25 T TİPİ TORX ALLEN ANAHTAR	138	4921220080	8 MM T TİP YUVARLAK BAŞLI ALLEN	139	5501230300	300 MM ELTA DÜZ KESKİ	191
4909220027	T 27 T TİPİ TORX ALLEN ANAHTAR	138	4921220100	10 MM T TİP YUVARLAK BAŞLI ALLEN	139	5510230125	125 MM TESVİYECİ DUZ KESKİ KROM	144
4909220030	T 30 T TİPİ TORX ALLEN ANAHTAR	138	4922008108	8'Lİ ELTA T TİPİ ALLEN ANAHTAR TK.	191	5510230150	150 MM TESVİYECİ DUZ KESKİ KROM	144
4909220040	T 40 T TİPİ TORX ALLEN ANAHTAR	138	4922220025	2,5 MM ELTA T TİPİ ALLEN ANAHTAR	191	5520230125	125 MM TIRNAK KESKİ KROM	144

KOD CODE	ÜRÜN İSMİ PRODUCT NAME	SAYFA NO PAGE NUMBER	KOD CODE	ÜRÜN İSMİ PRODUCT NAME	SAYFA NO PAGE NUMBER	KOD CODE	ÜRÜN İSMİ PRODUCT NAME	SAYFA NO PAGE NUMBER
5520230150	150 MM TIRNAK KESKI KROM	144	5700240011	11 MM KAYIŞ ZIMBASI	145	5801250500	500 GR ELTA ÇEKİÇ	192
5521230125	125 MM ELTA TIRNAK KESKI BOYALI	192	5700240012	12 MM KAYIŞ ZIMBASI	145	5801251000	1000 GR ELTA ÇEKİÇ	192
5521230150	150 MM ELTA TIRNAK KESKI BOYALI	192	5700240013	13 MM KAYIŞ ZIMBASI	145	5801251500	1500 GR ELTA ÇEKİÇ	192
5540240412	4X120 NOKTA ZIMBA KROM KAPLI	144	5700240014	14 MM KAYIŞ ZIMBASI	145	5801252000	2000 GR ELTA ÇEKİÇ	192
5540244120	4X120 NOKTA ZIMBA BOYALI	144	5700240015	15 MM KAYIŞ ZIMBASI	145	5810251000	1000 GR EMNİYET ÇEKİCİ	146
5540245120	5x120 NOKTA ZIMBA BOYALI	144	5700240016	16 MM KAYIŞ ZIMBASI	145	5810251500	1500 GR EMNİYET ÇEKİCİ	146
5540245150	5X150 NOKTA ZIMBA BOYALI	144	5700240017	17 MM KAYIŞ ZIMBASI	145	5810252000	2000 GR EMNİYET ÇEKİCİ	146
5545240002	2 MM KONİK PİM ZIMBA BOYALI	144	5700240018	18 MM KAYIŞ ZIMBASI	145	5850250030	30 PLASTİK ÇEKİÇ	146
5545240003	3 MM KONİK PİM ZIMBA BOYALI	144	5700240019	19 MM KAYIŞ ZIMBASI	145	5850250040	40 PLASTİK ÇEKİÇ	146
5545240004	4 MM KONİK PİM ZIMBA BOYALI	144	5700240020	20 MM KAYIŞ ZIMBASI	145	5850250050	50 PLASTİK ÇEKİÇ	146
5545240005	5 MM KONİK PİM ZIMBA BOYALI	144	5700241021	21 MM KAYIŞ ZIMBASI	145	5850250130	30 PLASTİK ÇEKİÇ YEDEK PARÇASI	197
5545240006	6 MM KONİK PİM ZIMBA BOYALI	144	5700241022	22 MM KAYIŞ ZIMBASI	145	5850250140	40 PLASTİK ÇEKİÇ YEDEK PARÇASI	197
5545240007	7 MM KONİK PİM ZIMBA BOYALI	144	5700241023	23 MM KAYIŞ ZIMBASI	145	5850250150	50 PLASTİK ÇEKİÇ YEDEK PARÇASI	197
5545240008	8 MM KONİK PİM ZIMBA BOYALI	144	5700241024	24 MM KAYIŞ ZIMBASI	145	5851250030	30 ELTA PLASTİK ÇEKİÇ	193
5545240009	9 MM KONİK PİM ZIMBA BOYALI	144	5700241025	25 MM KAYIŞ ZIMBASI	145	5851250130	30 ELTA PLASTİK ÇEKİÇ YEDEĞİ	199
5545240010	10 MM KONİK PİM ZIMBA BOYALI	144	5700241026	26 MM KAYIŞ ZIMBASI	145	5851250140	40 ELTA PLASTİK ÇEKİÇ YEDEĞİ	199
5545240012	12 MM KONİK PİM ZIMBA BOYALI	144	5700241029	29 MM KAYIŞ ZIMBASI	145	5865250001	MADIRGA 1000 GR SAP	197
5545240103	3 MM KONİK PİM ZIMBASI KROM KAPLI	144	5700241030	30 MM KAYIŞ ZIMBASI	145	5865250002	MADIRGA 1500 GR SAP	197
5546240002	2 MM ELTA KONİK PİM ZIMBA	192	5700241032	32 MM KAYIŞ ZIMBASI	145	5865251000	1000 GR MADIRGA	147
5546240003	3 MM ELTA KONİK PİM ZIMBA	192	5701240003	03 MM ELTA KAYIŞ ZIMBA	192	5865251500	1500 GR MADIRGA	147
5546240004	4 MM ELTA KONİK PİM ZIMBA	192	5701240004	04 MM ELTA KAYIŞ ZIMBA	192	5870250400	400 GR LASTİK CEKİC	146
5546240005	5 MM ELTA KONİK PİM ZIMBA	192	5701240005	05 MM ELTA KAYIŞ ZIMBA	192	5884260003	3 M ELTA ŞERİT METRE (PLS)	193
5546240006	6 MM ELTA KONİK PİM ZIMBA	192	5701240006	06 MM ELTA KAYIŞ ZIMBA	192	5884260005	5 M ELTA ŞERİT METRE (PLS)	193
5546240007	7 MM ELTA KONİK PİM ZIMBA	192	5701240007	07 MM ELTA KAYIŞ ZIMBA	192	5891260830	300 mm ELTA TESTERE KOLU	193
5546240008	8 MM ELTA KONİK PİM ZIMBA	192	5701240008	08 MM ELTA KAYIŞ ZIMBA	192	6195260260	260 MM PERÇİN TABANCASI	153
5546240009	9 MM ELTA KONİK PİM ZIMBA	192	5701240009	09 MM ELTA KAYIŞ ZIMBA	192	6205270240	240 MM ALÜMİNYUM SAÇ KESME MAKASI (SAĞ)	163
5546240010	10 MM ELTA KONİK PİM ZIMBA	192	5701240010	10 MM ELTA KAYIŞ ZIMBA	192	6206270240	240 MM ALÜMİNYUM SAÇ KESME MAKASI (SOL)	163
5550001006	6'LI DÜZ PİM ZIMBA TAKIMI BOYALI	144	5701240011	11 MM ELTA KAYIŞ ZIMBA	192	6207270240	240 MM ALÜMİNYUM SAÇ KESME MAKASI (DÜZ)	163
5550240002	2 MM DÜZ PİM ZIMBA BOYALI	144	5701240012	12 MM ELTA KAYIŞ ZIMBA	192	6210270250	250 MM KAPORTACI MAKASI (SAG)	164
5550240003	3 MM DÜZ PİM ZIMBA BOYALI	144	5701240013	13 MM ELTA KAYIŞ ZIMBA	192	6210270275	275 MM KAPORTACI MAKASI (SAĞ)	164
5550240004	4 MM DÜZ PİM ZIMBA BOYALI	144	5701240014	14 MM ELTA KAYIŞ ZIMBA	192	6210270300	300 MM KAPORTACI MAKASI (SAG)	164
5550240005	5 MM DÜZ PİM ZIMBA BOYALI	144	5701240015	15 MM ELTA KAYIŞ ZIMBA	192	6211270250	250 MM KAPORTACI MAKASI (SOL)	164
5550240006	6 MM DÜZ PİM ZIMBA BOYALI	144	5701240016	16 MM ELTA KAYIŞ ZIMBA	192	6211270275	275 MM KAPORTACI MAKASI (SOL)	164
5550240007	7 MM DÜZ PİM ZIMBA BOYALI	144	5701240017	17 MM ELTA KAYIŞ ZIMBA	192	6211270300	300 MM KAPORTACI MAKASI (SOL)	164
5550240008	8 MM DÜZ PİM ZIMBA BOYALI	144	5701240018	18 MM ELTA KAYIŞ ZIMBA	192	6220260500	500 GR SİRALLİ MIKNATIS	153
5550240009	9 MM DÜZ PİM ZIMBA BOYALI	144	5701240019	19 MM ELTA KAYIŞ ZIMBA	192	6220261000	1000 GR SİRALLİ MIKNATIS	153
5550240010	10 MM DÜZ PİM ZIMBA BOYALI	144	5701240020	20 MM ELTA KAYIŞ ZIMBA	192	6225260200	200 cc MADENİ YAĞDANLIK	153
5550240105	5 MM DÜZ PİM ZIMBA KROM KAPLI	144	5800250001	100 GR ÇEKİÇ SAPI	197	6225260300	300 cc MADENİ YAĞDANLIK	153
5551240002	2 MM ELTA DÜZ PİM ZIMBA	192	5800250002	200 GR ÇEKİÇ SAPI	197	6225260500	500 cc MADENİ YAĞDANLIK	153
5551240006	6 MM ELTA DÜZ PİM ZIMBA	192	5800250003	300 GR ÇEKİÇ SAPI	197	6230260300	(300 CC) GRES POMPASI İZELTAŞ KAVAL BORULU	155
5551240008	8 MM ELTA DÜZ PİM ZIMBA	192	5800250005	500 GR ÇEKİÇ SAPI	197	6230260500	(500 CC) GRES POMPASI İZELTAŞ KAVAL BORULU	155
5551240010	10 MM ELTA DÜZ PİM ZIMBA	192	5800250010	1000 GR ÇEKİÇ SAPI	197	6230262500	GRES POMPASI UCU (300 CC VE 500 CC)	198
5600006106	6 PARÇA KESKI-ZIMBA TAKIMI	145	5800250015	1500 GR ÇEKİÇ SAPI	197	6230263300	300 CC GRES POMPASI HORTUMU	198
5700002110	10 LU KAYIŞ ZIMBA TAKIMI	145	5800250020	2000 GR ÇEKİÇ SAPI	197	6230263500	500 CC GRES POMPASI HORTUMU	198
5700002112	12 LI KAYIŞ ZIMBA TAKIMI	145	5800250100	100 GR TESVİYECİ ÇEKİCİ	146	6235190220	220 MM SÜBAP AYAR TORNAVİDASI	155
5700240003	3 MM KAYIŞ ZIMBASI	145	5800250200	200 GR TESVİYECİ ÇEKİCİ	146	6240260810	8x10 MM TAPA ANAHTARI	155
5700240004	4 MM KAYIŞ ZIMBASI	145	5800250300	300 GR TESVİYECİ ÇEKİCİ	146	6350260300	300 MM OLUKLU LEVYE KROM	155
5700240005	5 MM KAYIŞ ZIMBASI	145	5800250500	500 GR TESVİYECİ ÇEKİCİ	146	6350260400	400 MM OLUKLU LEVYE KROM	155
5700240006	6 MM KAYIŞ ZIMBASI	145	5800251000	1000 GR TESVİYECİ ÇEKİCİ	146	6350260500	500 MM OLUKLU LEVYE KROM	155
5700240007	7 MM KAYIŞ ZIMBASI	145	5800251500	1500 GR TESVİYECİ ÇEKİCİ	146	6350260600	600 MM OLUKLU LEVYE KROM	155
5700240008	8 MM KAYIŞ ZIMBASI	145	5800252000	2000 GR TESVİYECİ ÇEKİCİ	146	6351260400	400 MM ELTA OLUKLU LEVYE	193
5700240009	9 MM KAYIŞ ZIMBASI	145	5801250100	100 GR ELTA CEKİC	192	6351260500	500 MM ELTA OLUKLU LEVYE	193
5700240010	10 MM KAYIŞ ZIMBASI	145	5801250200	200 GR ELTA CEKİC	192	6351260600	600 MM ELTA OLUKLU LEVYE	193

KOD CODE	ÜRÜN İSMİ PRODUCT NAME	SAYFA NO PAGE NUMBER
6360260600	600 MM KIVIRIK UCLU LEVYE KROM	155
6370260100	100 MM YAĞ FİLTRESİ SÖKECEĞİ	155
6371263120	ÜÇ AYAKLI YAĞ FİLTRE SÖKECEĞİ	155
6375266512	65-120 ÜÇ AYAKLI YAĞ FİLTRE SÖKECEĞİ ÇİFT YÖNLÜ	156
6380266016	60x160 MM ÇİFT ZİNCİRLİ YAĞ FİLTRE SÖKECEĞİ	156
6400250001	400 GR KESER SAPI	197
6400250600	400 GR KESER	147
6401250600	400 GR USTA KESERİ	147
6410250001	NACAK YEDEK SAP	197
6410250800	800 GR NACAK	147
6710270230	230 MM BAĞ MAKASI LUKS PVC	166
6712270210	210 MM ELMA MAKASI	166
6715270225	225 MM BAĞ MAKASI(CONFORT TİP)	166
6720270220	220 MM BAĞ MAKASI (HAFİF TİP)	166
6721270205	205 MM ELTA BAĞ MAKASI	193
6722270220	220 MM ELTA BAĞ MAKASI(HAFİF TİP)	193
6730270550	550 MM ELTA ÇİM KESME MAKASI DÜZ AĞIZ	194
6731270650	650 MM ELTA ÇİM KESME MAKASI EĞRİ AĞIZ	194
6735270300	300 MM BUDAMA TESTERE	152
6735271300	300 MM BUDAMA TESTERE YEDEĞİ	198
6740270140	140 MM KOMBİNE MAKAS	165
6740270190	190 MM KOMBİNE MAKAS	165
6760270125	125 MM NARENÇİYE MAKASI	166
6800270180	180 MM KUYUMCU MAKASI DUZ	165
6801270180	180 MM KUYUMCU MAKASI EĞRİ	165
6815270200	200 MM TEL KESME MAKASI	165
6820270200	200 MM TENEKECİ MAKASI PVC KAPLI	164
6820270250	250 MM TENEKECİ MAKASI PVC KAPLI	164
6820270300	300 MM TENEKECİ MAKASI PVC KAPLI	164
6821270250	250 MM TENEKECİ MAKASI YAYLI	164
6821270300	300 MM TENEKECİ MAKASI YAYLI	164
6850280322	MINİ BORU KESİCİ	167
6850281322	MINİ-STD.-TELESKOPIK BIÇAĞI	198
6855280330	STANDART BORU KESİCİ	167
6860280635	TELESKOPIK BORU KESİCİ	167
6865280150	PROFESYONEL BORU KESİCİ BIÇAĞI	198
6865281050	PROFESYONEL BORU KESİCİ	167
7010006105	5 PARÇA ÇEKTİRME SEHPASI	171
7010290810	08x10 STANDART İKİ KOLLU ÇEKTİRME	171
7010290822	08*10/12*10 ÇEKTİRME KOLU	199
7010290833	08*10/12*10 BAĞLANTI PARÇASI	199
7010290844	08X10-12X10 ÇEKTİRME MILİ	199
7010291210	12x10 STANDART İKİ KOLLU ÇEKTİRME	171
7010291615	16x15 STANDART İKİ KOLLU ÇEKTİRME	171
7010291622	16*15/20*15 ÇEKTİRME KOLU	199
7010291633	16*15/20*15 BAĞLANTI PARÇASI	199
7010291644	16X15-20X15 ÇEKTİRME MILİ	199
7010292015	20x15 STANDART İKİ KOLLU ÇEKTİRME	171
7010292033	20 LİK UZATMA KOLU	199
7010292520	25x20 STANDART İKİ KOLLU ÇEKTİRME	171
7010292522	25X20-35X20-52X20 ST.ÇEKT.KOLU	199
7010292533	25X20-35X20-52X20 ST.ÇEKT.BAĞLANTI	199
7010292544	25X20 ÇEKTİRME MILİ	199

KOD CODE	ÜRÜN İSMİ PRODUCT NAME	SAYFA NO PAGE NUMBER
7010293033	30 LUK UZATMA KOLU	199
7010293520	35x20 STANDART İKİ KOLLU ÇEKTİRME	171
7010293544	35X20/37x20 ÇEKTİRME MILİ	199
7010294033	40 LİK UZATMA KOLU	199
7010295220	52x20 STANDART İKİ KOLLU ÇEKTİRME	171
7010295244	52X20 ÇEKTİRME MILİ	199
7010316105	ÇEKTİRME SEHPASI BOS	202
7020293720	37x20 STANDART ÜÇ KOLLU ÇEKTİRME	171
7020295220	52x20 STANDART ÜÇ KOLLU ÇEKTİRME	171
7030290808	08X08 MASTER İKİ KOLLU ÇEKTİRME	172
7030290822	08X08 MASTER ÇEKTİRME KOLU	199
7030290844	08X08 MASTER ÇEKTİRME MILİ	199
7030291212	12X12 MASTER İKİ KOLLU ÇEKTİRME	172
7030291222	12X12 MASTER ÇEKTİRME KOLU	199
7030291244	12X12 MASTER ÇEKTİRME MILİ	199
7030291616	16X16 MASTER İKİ KOLLU ÇEKTİRME	172
7030291622	16X16 MASTER ÇEKTİRME KOLU	199
7030291644	16X16 MASTER ÇEKTİRME MILİ	199
7030292320	23X20 MASTER İKİ KOLLU ÇEKTİRME	172
7030292322	23X20 MASTER ÇEKTİRME KOLU	199
7030292344	23X20 MASTER ÇEKTİRME MILİ	199
7040290808	08X08 MASTER UC KOLLU ÇEKTİRME	172
7040291212	12X12 MASTER UC KOLLU ÇEKTİRME	172
7040291616	16X16 MASTER UC KOLLU ÇEKTİRME	172
7040292320	23X20 MASTER UC KOLLU ÇEKTİRME	172
7050290422	06X04 BATARYA ÇEKTİRME KOLU	199
7050290444	06X04 BATARYA ÇEKTİRME MILİ	199
7050290604	06X04 BATARYA İKİ KOLLU ÇEKTİRME	172
7050290606	06X06 BATARYA İKİ KOLLU ÇEKTİRME	172
7050290622	06X06 BATARYA ÇEKTİRME KOLU	199
7050290644	06X06 BATARYA ÇEKTİRME MILİ	199
7050290808	08X08 BATARYA İKİ KOLLU ÇEKTİRME	172
7050290822	08X08 BATARYA ÇEKTİRME KOLU	199
7050290844	08X08 BATARYA ÇEKTİRME MILİ	199
7060290604	06X04 BATARYA UC KOLLU ÇEKTİRME	172
7060290606	06X06 BATARYA UC KOLLU ÇEKTİRME	172
7060290808	08X08 BATARYA UC KOLLU ÇEKTİRME	172
7070292013	20X13 S TİPİ İKİ KOLLU ÇEKTİRME	173
7070292022	20X13 "S" TİPİ ÇEKTİRME KOLU	199
7070292044	20X13 "S" TİPİ ÇEKTİRME MILİ	199
7080292013	20X13 "S" TİPİ UC KOLLU ÇEKTİRME	173
7090292222	22X22 UNIVERSAL İKİ KOLLU ÇEKTİRME	173
7090292244	22X22 UNIVERSAL ÇEKTİRME MILİ	199
7090292322	22X22 UNIVERSAL ÇEKTİRME KOLU	199
7100292222	22X22 UNIVERSAL UC KOLLU ÇEKTİRME	173
7120290507	5-7 İÇ RULMAN ÇEKTİRME PENSLERİ	174
7120290709	7-9 İÇ RULMAN ÇEKTİRME PENSLERİ	174
7120290912	9-12 İÇ RULMAN ÇEKTİRME PENSLERİ	174
7120291013	10-13 İÇ RULMAN ÇEKTİRME PENSLERİ	174
7120291317	13-17 İÇ RULMAN ÇEKTİRME PENSLERİ	174
7120291419	14-19 İÇ RULMAN ÇEKTİRME PENSLERİ	174
7120291621	16-21 İÇ RULMAN ÇEKTİRME PENSLERİ	174
7120291823	18-23 İÇ RULMAN ÇEKTİRME PENSLERİ	174

KOD CODE	ÜRÜN İSMİ PRODUCT NAME	SAYFA NO PAGE NUMBER
7120292025	20-25 İÇ RULMAN ÇEKTİRME PENSLERİ	174
7120292530	25-30 İÇ RULMAN ÇEKTİRME PENSLERİ	174
7120292540	25-40 İÇ RULMAN ÇEKTİRME PENSLERİ	174
7120293037	30-37 İÇ RULMAN ÇEKTİRME PENSLERİ	174
7120293542	35-42 İÇ RULMAN ÇEKTİRME PENSLERİ	174
7120293575	35-75 İÇ RULMAN ÇEKTİRME KOLLARI	174
7120293845	38-45 İÇ RULMAN ÇEKTİRME PENSLERİ	174
7120294350	43-50 İÇ RULMAN ÇEKTİRME PENSLERİ	174
7120294555	45-55 İÇ RULMAN ÇEKTİRME PENSLERİ	174
7120295060	50-60 İÇ RULMAN ÇEKTİRME PENSLERİ	174
7120296013	60-130 İÇ RULMAN ÇEKTİRME KOLLARI	174
7122290560	05-60 DIŞ RULMAN ÇEKTİRME ÇENELERİ	175
7122291036	100-360 DIŞ RULMAN ÇEKTİRME KOLLARI	175
7122291275	12-75 DIŞ RULMAN ÇEKTİRME ÇENELERİ	175
7122291443	140-435 DIŞ RULMAN ÇEKTİRME KOLLARI	175
7122292211	22-115 DIŞ RULMAN ÇEKTİRME ÇENELERİ	175
7122292515	25-155 DIŞ RULMAN ÇEKTİRME ÇENELERİ	175
7122293022	30-220 DIŞ RULMAN ÇEKTİRME ÇENELERİ	175
7122294011	40-115 DIŞ RULMAN ÇEKTİRME KOLLARI	175
7122294028	40-280 DIŞ RULMAN ÇEKTİRME ÇENELERİ	175
7122295520	55-205 DIŞ RULMAN ÇEKTİRME KOLLARI	175
7122299026	90-260 DIŞ RULMAN ÇEKTİRME KOLLARI	175
7125290045	45 MM ROTİL ÇEKTİRME(SAPLI)	175
7126290018	18 MM ROTİL ÇEKTİRME(TEK VİDALI)	175
7126290025	25 MM ROTİL ÇEKTİRME(TEK VİDALI)	175
7126290029	29 MM ROTİL ÇEKTİRME(TEK VİDALI)	175
7126290040	40 MM ROTİL ÇEKTİRME(TEK VİDALI)	175
7126290045	45 MM ROTİL ÇEKTİRME(TEK VİDALI)	175
7300301012	100x12 İŞKENCE (MARANGOZ MENGENESİ)	160
7300303012	30x12 İŞKENCE (MARANGOZ MENGENESİ)	160
7300304012	40x12 İŞKENCE (MARANGOZ MENGENESİ)	160
7300305012	50x12 İŞKENCE (MARANGOZ MENGENESİ)	160
7300306012	60x12 İŞKENCE (MARANGOZ MENGENESİ)	160
7300308012	80x12 İŞKENCE (MARANGOZ MENGENESİ)	160
7300316150	İŞKENCE SEHPASI(BOŞ)	202
7310301005	10x5 MINİ İŞKENCE	160
7310301505	15x5 MINİ İŞKENCE	160
7310302005	20x5 MINİ İŞKENCE	160
7310302505	25x5 MINİ İŞKENCE	160
7310303005	30x5 MINİ İŞKENCE	160
7400000100	100 MM SABİT MENGENE VE ALTLIĞI	159
7400000125	125 MM SABİT MENGENE VE ALTLIĞI	159
7400000150	150 MM SABİT MENGENE VE ALTLIĞI	159
7400000175	175 MM SABİT MENGENE VE ALTLIĞI	159
7400300100	100 MM DÖVME ÇELİK MENGENE	159
7400300125	125 MM DÖVME ÇELİK MENGENE	159
7400300150	150 MM DÖVME ÇELİK MENGENE	159
7400300175	175 MM DÖVME ÇELİK MENGENE	159
7401300100	100 MM SABİT MENGENE ALTLIĞI	159
7401300125	125 MM SABİT MENGENE ALTLIĞI	159
7401300150	150 MM SABİT MENGENE ALTLIĞI	159
7401300175	175 MM SABİT MENGENE ALTLIĞI	159
8001316012	ÇATAL ANAHTAR SEHPASI(BOS)	203

KOD CODE	ÜRÜN İSMİ PRODUCT NAME	SAYFA NO PAGE NUMBER	KOD CODE	ÜRÜN İSMİ PRODUCT NAME	SAYFA NO PAGE NUMBER
8002316012	YILDIZ ANAHTAR SEHPASI	203	8243001096	5 ÇEK. EKO SERİSİ TAKIM DOLABI KIRMIZI (DOLU - 93)	22
8004316004	MENGENE SEHPASI (BOŞ)	203	8243002052	EKO SERİ 2. ÇEKMECE İÇİ 49 PARÇA	23
8010316001	1 Lİ PANO (BOŞ)	204	8243003013	EKO SERİ 3. ÇEKMECE İÇİ 13 PARÇA	23
8011316001	TEŞHİR PANOSU ELTA (BOŞ)	194	8243007096	7 ÇEK. EKO SERİSİ TAKIM DOLABI KIRMIZI (DOLU - 93)	22
8015316001	TEKERLEKLİ ÜÇGEN PANO	203	8243321005	ECO SERİ 5 ÇEKMECELİ TK. DL. KIRMIZI GÖVDE - GRİ ÇEKMECE	22
8160326001	TAKIM DOLABI (BOŞ) 250X643X943	27	8243321007	ECO SERİ 7 ÇEKMECELİ TAKIM DOLABI KIRMIZI GÖVDE - GRİ ÇEKMECE	22
8210326001	TEKERLEKLİ TAMIR DOLABI (VAGON MODELİ)	26	8243322005	ECO SERİ 5 ÇEKMECELİ TAKIM DOLABI MAVİ GÖVDE - GRİ ÇEKMECE	22
8235001072	PARTNER DOLAP 1. ÇEKMECE İÇİ 69 PARÇA	20	8243322007	ECO SERİ 7 ÇEKMECELİ TAKIM DOLABI MAVİ GÖVDE - GRİ ÇEKMECE	22
8235002031	PARTNER DOLAP 2. ÇEKMECE İÇİ 31 PARÇA	21	8243323005	ECO SERİ 5 ÇEKMECELİ TAKIM DOLABI GRİ GÖVDE - GRİ ÇEKMECE	22
8235003017	PARTNER DOLAP 3. ÇEKMECE İÇİ 17 PARÇA	21	8243323007	ECO SERİ 7 ÇEKMECELİ TAKIM DOLABI GRİ GÖVDE - GRİ ÇEKMECE	22
8235006121	5 ÇEKMECELİ PARTNER MOBİL TAKIM DOLABI DOLU 118 PARÇA	19	8244001030	TREND SERİ 1. ÇEKMECE İÇİ 30 PARÇA	25
8235325005	5 ÇEKMECELİ PARTNER MOBİL TAKIM DOLABI MAVİ (BOŞ)	19	8244002052	TREND SERİ 2. ÇEKMECE İÇİ 49 PARÇA	25
8235326005	5 ÇEKMECELİ PARTNER MOBİL TAKIM DOLABI KIRMIZI (BOŞ)	19	8244003013	TREND SERİ 3. ÇEKMECE İÇİ 13 PARÇA	25
8235327005	5 ÇEKMECELİ PARTNER MOBİL TAKIM DOLABI SİYAH (BOŞ)	19	8244005096	TREND SERİSİ 5 ÇEKMECELİ TK. DOLABI KIRMIZI (DOLU - 93)	24
8241001030	PRO SERİ 1. ÇEKMECE İÇİ 30 PARÇA	8	8244007096	TREND SERİSİ 7 ÇEKMECELİ TAKIM DOLABI KIRMIZI (DOLU - 93)	24
8241001209	8 ÇEKMECELİ PRO SERİSİ TAKIM DOLABI KIRMIZI (DOLU - 206)	7	8244321005	TREND SERİSİ 5 ÇEKMECELİ TK. DOLABI KIRMIZI GÖVDE - GRİ ÇEKMECE	24
8241002072	PRO SERİ 2. ÇEKMECE İÇİ 69 PARÇA	8	8244321007	TREND SERİSİ 7 ÇEKMECELİ TK. DOLABI KIRMIZI GÖVDE - GRİ ÇEKMECE	24
8241003051	PRO SERİ 3. ÇEKMECE İÇİ 51 PARÇA	8	8245001042	1. ÇEKMECE PREMIUM SERİSİ DOLAP 42 PARÇA	12
8241004027	PRO SERİ 4. ÇEKMECE İÇİ 27 PARÇA	9	8245002094	2. ÇEKMECE PREMIUM SERİSİ DOLAP 91 PARÇA	12
8241005010	PRO SERİ 5. ÇEKMECE İÇİ 10 PARÇA	9	8245003014	3. ÇEKMECE PREMIUM SERİSİ DOLAP 14 PARÇA	12
8241006018	PRO SERİ 6. ÇEKMECE İÇİ 18 PARÇA	9	8245004043	4. ÇEKMECE PREMIUM SERİSİ DOLAP 43 PARÇA	13
8241321005	PRO SERİ 5 ÇEKMECELİ TAKIM DL. GRİ GÖVDE - KIRMIZI ÇEKMECE	7	8245005043	5. ÇEKMECE PREMIUM SERİSİ DOLAP 43 PARÇA	13
8241321006	PRO SERİ 6 ÇEKMECELİ TAKIM DL. GRİ GÖVDE - KIRMIZI ÇEKMECE	7	8245006009	6. ÇEKMECE PREMIUM SERİSİ DOLAP 9 PARÇA	13
8241321007	PRO SERİ 7 ÇEKMECELİ TAKIM DL. GRİ GÖVDE - KIRMIZI ÇEKMECE	7	8245007096	PREMIUM SERİSİ TAKIM DOLABI 7 ÇEKMECE DOLU 242 PARÇA	11
8241321008	PRO SERİ 8 ÇEKMECELİ TAKIM DL. GRİ GÖVDE - KIRMIZI ÇEKMECE	7	8245321005	PREMIUM SERİSİ TAKIM DOLABI 5 ÇEKMECE	11
8241322005	PRO SERİ 5 ÇEKMECELİ TAKIM DL. GRİ GÖVDE - MAVİ ÇEKMECE	7	8245321007	PREMIUM SERİSİ TAKIM DOLABI 7 ÇEKMECE	11
8241322006	PRO SERİ 6 ÇEKMECELİ TAKIM DL. GRİ GÖVDE - MAVİ ÇEKMECE	7	8320331001	KÜÇÜK ALET SANDIĞI ÇEKMECELİ KIRMIZI BOŞ (285X450X322)	32
8241322007	PRO SERİ 7 ÇEKMECELİ TAKIM DL. GRİ GÖVDE - MAVİ ÇEKMECE	7	8320331002	ORTA ALET SANDIĞI ÇEKMECELİ KIRMIZI BOŞ (285X550X322)	32
8241322008	PRO SERİ 8 ÇEKMECELİ TAKIM DL. GRİ GÖVDE - MAVİ ÇEKMECE	7	8320331003	BÜYÜK ALET SANDIĞI ÇEKMECELİ KIRMIZI BOŞ (285X650X322)	32
8241323005	PRO SERİ 5 ÇEKMECELİ TAKIM DL. GRİ GÖVDE - GRİ ÇEKMECE	7	8410336103	3 GÖZLÜ KÜÇÜK TAKIM ÇANTASI	33
8241323006	PRO SERİ 6 ÇEKMECELİ TAKIM DL. GRİ GÖVDE - GRİ ÇEKMECE	7	8410336203	3 GÖZLÜ BÜYÜK TAKIM ÇANTASI	33
8241323007	PRO SERİ 7 ÇEKMECELİ TAKIM DL. GRİ GÖVDE - GRİ ÇEKMECE	7	8420005028	TESİSATÇI TAKIM ÇANTASI DOLU 5 GÖZLÜ 28 PARÇA	34
8241323008	PRO SERİ 8 ÇEKMECELİ TAKIM DL. GRİ GÖVDE - GRİ ÇEKMECE	7	8420005046	ELEKTRİKÇİ TAKIM ÇANTASI DOLU 5 GÖZLÜ 45 PARÇA	34
8242001030	GARAJ SERİ 1. ÇEKMECE İÇİ 30 PARÇA	16	8420005063	MEKANİKÇİ TAKIM ÇANTASI DOLU 5 GÖZLÜ 62 PARÇA	34
8242001142	7 ÇEKMECELİ GARAJ SERİSİ TAKIM DOLABI KIRMIZI (DOLU - 139)	15	8420336105	5 GOZLU KUCUK TAKIM CANTASI	33
8242002072	GARAJ SERİ 2. ÇEKMECE İÇİ 69 PARÇA	16	8420336205	5 GOZLU BUYUK TAKIM CANTASI	33
8242003010	GARAJ SERİ 3. ÇEKMECE İÇİ 10 PARÇA	17	8420336305	5 GOZLU TAKIM ÇANTASI UZUN	33
8242004018	GARAJ SERİ 4. ÇEKMECE İÇİ 18 PARÇA	17	8420336405	5 GOZLU TAKIM ÇANTASI UZUN 600 MM	33
8242005011	GARAJ SERİ 5. ÇEKMECE İÇİ 11 PARÇA	17	8440001023	19" PLASTİK TAKIM ÇANTASI ELEKTRİKÇİ SET DOLU (23 PARÇA)	114
8242008142	8 ÇEKMECELİ GARAJ SERİSİ TK. DOLABI KIRMIZI (DOLU - 139)	15	8440331016	16" PLASTİK TAKIM ÇANTASI	36
8242321005	GARAGE SERİSİ 5 ÇEKMECELİ TK. DL. KIRMIZI GÖVDE - GRİ ÇEKMECE	15	8440331019	19" PLASTİK TAKIM ÇANTASI	36
8242321006	GARAGE SERİSİ 6 ÇEKMECELİ TK. DL. KIRMIZI GÖVDE - GRİ ÇEKMECE	15	8440331022	22" PLASTİK TAKIM ÇANTASI	36
8242321007	GARAGE SERİSİ 7 ÇEKMECELİ TK. DL. KIRMIZI GÖVDE - GRİ ÇEKMECE	15	8445331028	28" TEKERLEKLİ TAKIM ÇANTASI	36
8242321008	GARAGE SERİSİ 8 ÇEKMECELİ TK. DL. KIRMIZI GÖVDE - GRİ ÇEKMECE	15	8500346001	SERVİS MASASI (PANOLU)	30
8242322005	GARAGE SERİSİ 5 ÇEKMECELİ TK. DL. MAVİ GÖVDE - GRİ ÇEKMECE	15	8501346001	SERVİS MASASI (PANOSUZ)	30
8242322006	GARAGE SERİSİ 6 ÇEKMECELİ TK. DL. MAVİ GÖVDE - GRİ ÇEKMECE	15	8502346001	DEMONTE SERVİS MASASI	31
8242322007	GARAGE SERİSİ 7 ÇEKMECELİ TK. DL. MAVİ GÖVDE - GRİ ÇEKMECE	15	8545341005	TAŞIMA ARABASI	29
8242322008	GARAGE SERİSİ 8 ÇEKMECELİ TK. DL. MAVİ GÖVDE - GRİ ÇEKMECE	15	8550346001	SERVİS ARABASI BÜYÜK BOY	29
8242323005	GARAGE SERİSİ 5 ÇEKMECELİ TK. DL. GRİ GÖVDE - GRİ ÇEKMECE	15	8550348001	DEMONTE SERVİS ARABASI KÜÇÜK BOY	28
8242323006	GARAGE SERİSİ 6 ÇEKMECELİ TK. DL. GRİ GÖVDE - GRİ ÇEKMECE	15	8550348002	DEMONTE SERVİS ARABASI KÜÇÜK BOY (KAPALI)	28
8242323007	GARAGE SERİSİ 7 ÇEKMECELİ TK. DL. GRİ GÖVDE - GRİ ÇEKMECE	15	8705006113	13 PARÇA HOBBY SET OTO TİPİ	36
8242323008	GARAGE SERİSİ 8 ÇEKMECELİ TK. DL. GRİ GÖVDE - GRİ ÇEKMECE	15	8786001003	İZELTAS DOĞADA SETİ (3 PARÇA)	37
8243001030	EKO SERİSİ 1. ÇEKMECE İÇİ 30 PARÇA	23	8790008106	BAKIM ONARIM SETİ 5 PARÇA	36
			8790001014	BAKIM SETİ 14 PARÇA	37
			8795006005	1000V ELEKTRİKÇİ SET (5 PARÇA)	114



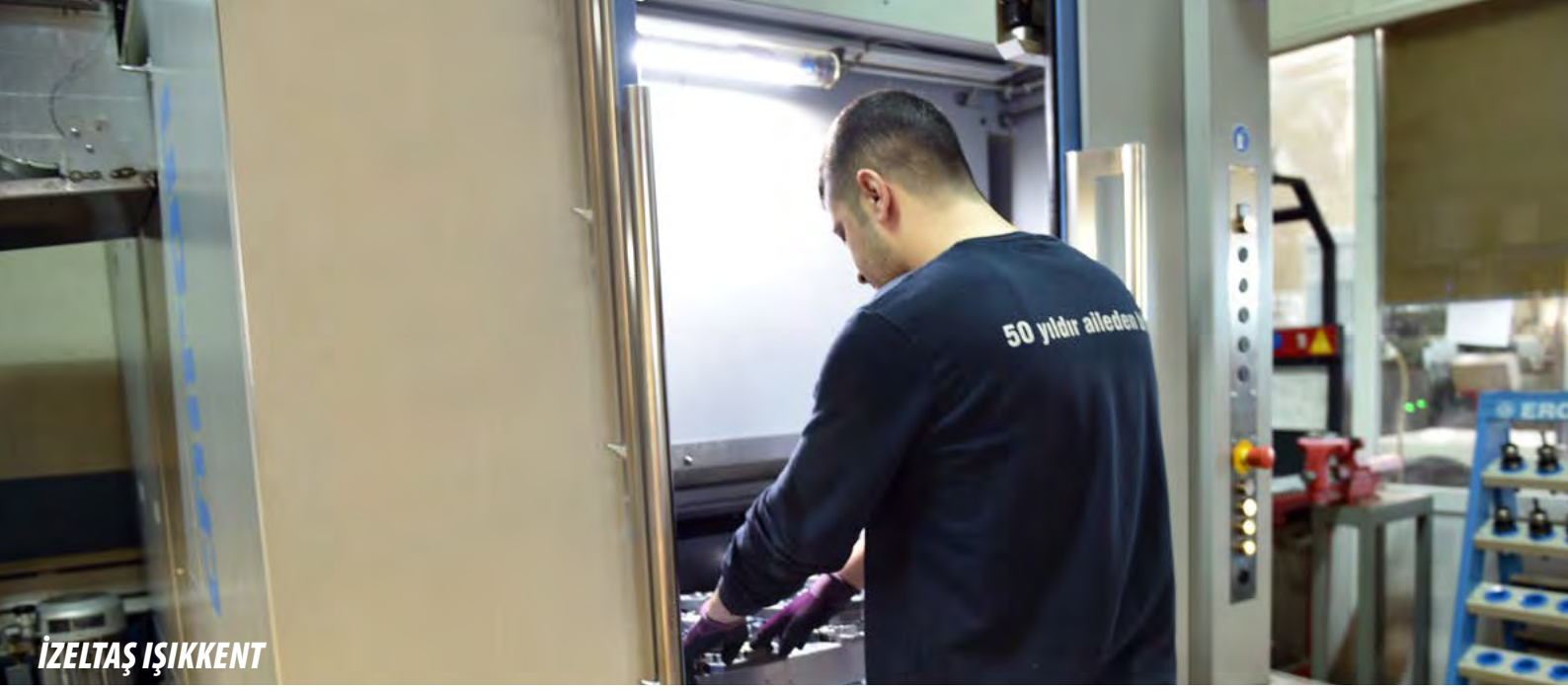

İZELTAŞ IŞIKKENT



İZELTAŞ TURGUTLU

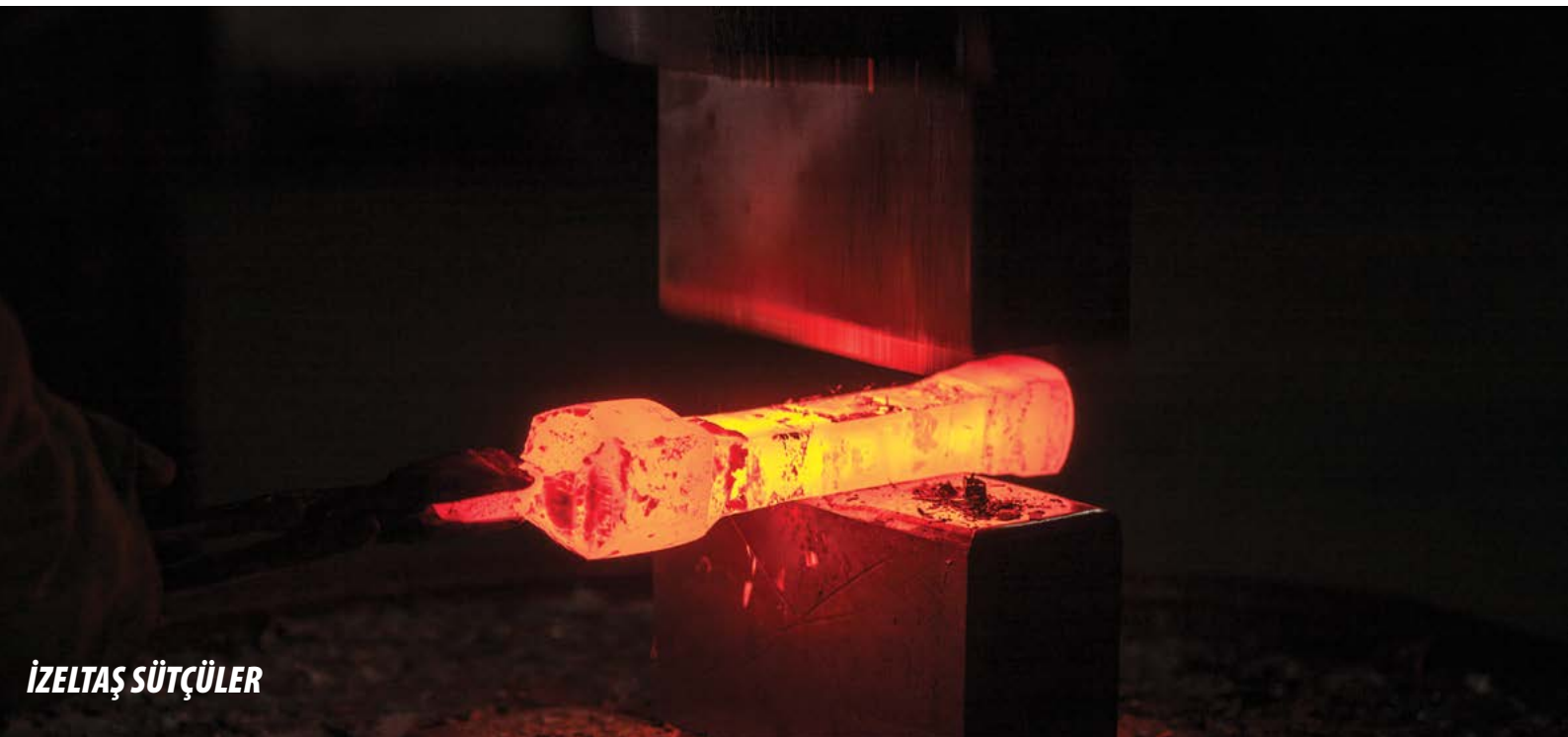

İZELTAŞ SÜTÇÜLER



İZMİR EL ALETLERİ SANAYİ VE TİCARET A.Ş.
Kemalpaşa Caddesi No: 303 Işıkkent İzmir - TÜRKİYE

SİPARİŞ TEL / PHONE FOR ORDERS

Direkt: +90.232 472 13 92

Santral Tel: +90.232 472 13 75

Fax: +90.232 472 13 78

ANKARA BÖLGE MÜDÜRLÜĞÜ

ANKARA OFFICE

Tel: +90 533 603 47 29

İSTANBUL BÖLGE MÜDÜRLÜĞÜ

İSTANBUL OFFICE

Tel: +0533 603 4181 - 0535 461 5487



 **IZELTAS®**

 www.izeltas.com.tr

 info@izeltas.com.tr