

TEKNİK ÜRÜN

FİYAT LİSTESİ
2021/1



E-TRV sizi anlar!

Siz yaklaşınca evinizi ısıtmaya başlar,
evinizden uzaklaşınca ısıtmayı kapatır.

E.C.A. E-TRV tercih ettiğiniz oda sıcaklığına göre radyatörünüzü ayarlar, odayı hep aynı sıcaklıkta tutar. Böylece odalarınız arası sıcaklık farklarının da oluşmasını engeller. Üstelik, akıllı telefonunuzdan da yönetebilir ve E-TRV'nin tüm akıllı özelliklerini kullanabilirsiniz.

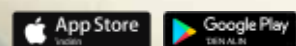

- E-TRV internete bağlanarak, mobil cihazınız üzerinden tüm özellikleri kontrol edilebilir veya E-TRV termostat başlığından sıcaklık değeri manuel ayarlanabilir.
 - E-TRV, günlük 15'er dakikalık zaman dilimlerinde 7/24 programlanabilir, konforu ve tasarrufu en üst seviyeye çıkarır.
 - 250 metre veya 25 km mesafe aralığında evinize yaklaştığınızda, siz gelmeden evinizi ısıtmaya başlar.
 - 6 Adet E-TRV internet köprüsü ile eşleştirilerek, mobil cihaz ile odalar birbirinden bağımsız olarak ayarlanabilir.
 - Uzun pil ömrü ile 2 yıldan fazla kullanım imkanı sağlar.



*Sadece E.C.A. İnternet Köprüsü ile çalışır.



AKILLI ELEKTRONİK TERMOSTATİK RADYATÖR VALFLERİ (E-TRV) Maksimum Enerji Tasarrufu ve Konfor

ÜRÜN	ÜRÜN KODU	ÜRÜN ADI	TEKNİK ÇİZİM	LİSTE FİYATI ₺	ÜRÜN KT. AD.
	602 120 966	İnternet Köprüsü + E-TRV + R1/2" F Gövde Köşe		2.260	2
	602 120 969	İnternet Köprüsü + E-TRV + R1/2" F Gövde Düz		2.266	2
	602 120 967	İnternet Köprüsü + E-TRV + Bağlantı Aparatları (RA/RAV/RAVL)		2.194	2
		Başlangıç Kiti			
	602 120 963	E-TRV + R1/2" F Gövde Köşe		1.153	6
	602 120 964	E-TRV + R1/2" F Gövde Düz		1.160	6
	602 499 423	E-TRV + Bağlantı Aparatları (RA/RAV/RAVL)		1.087	6
		Başlangıç Kiti			

• Fiyatlara KDV ayrıca dahil edilir. Tavsiye edilen bayi satış fiyatıdır.
SİRKÜLER NO: S2120101

%30 'A VARAN ENERJİ TASARRUFU

**TÜRKİYE'NİN İLK VE TEK
I. SINIF ENERJİ
VERİMLİLİĞİNE UYGUN
YERLİ ÜRETİM
TERMOSTATİK RADYATÖR VANASI!**

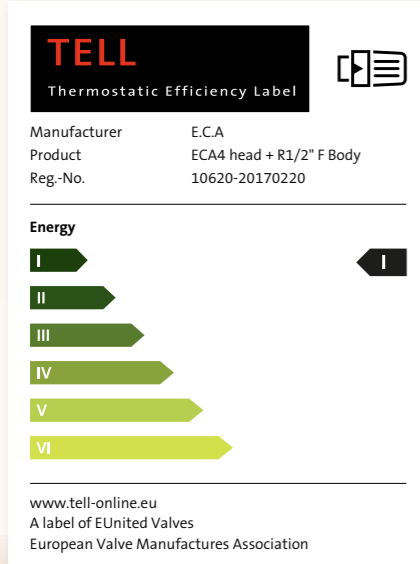



- * E.C.A. termostatik radyatör vanaları, normal radyatör vanalarına göre %30'a varan enerji tasarrufu sağlar.
- ** E.C.A.2 ve E.C.A.4 kafa grubuna sahip termostatik radyatör valflerimiz EUnited Valves tarafından TELL ürün sınıflandırma kapsamında I. sınıf enerji verimliliği seviyesinde onaylanmıştır.
- *** E.C.A. termostatik radyatör valfleri bir sezonda kendisini amorti eder.

TERMOSTATİK RADYATÖR VALFLERİ
EN 215, TS EN 215, %30'a varan Enerji Tasarrufu

ÜRÜN	ÜRÜN KODU	ÜRÜN ADI	TEKNİK ÇİZİM	LİSTE FİYATI ₺	ÜRÜN KT. AD.
	602 120 755	1/2" TERMOSTATİK RADYATÖR VALFİ KÖŞE TRV4 • 15°C Ortam Sıcaklığı Alt Limitli		107	22
	602 120 756	1/2" TERMOSTATİK RADYATÖR VALFİ DÜZ TRV4 • 15°C Ortam Sıcaklığı Alt Limitli		107	22
	602 120 531	1/2" TERMOSTATİK RADYATÖR VALFİ KÖŞE TRV3 • 15°C Ortam Sıcaklığı Alt Limitli		107	22
	602 120 532	1/2" TERMOSTATİK RADYATÖR VALFİ DÜZ TRV3 • 15°C Ortam Sıcaklığı Alt Limitli		107	22



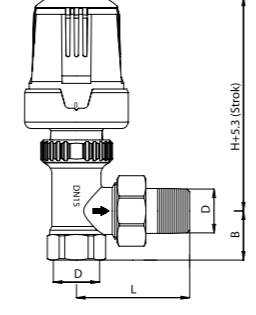

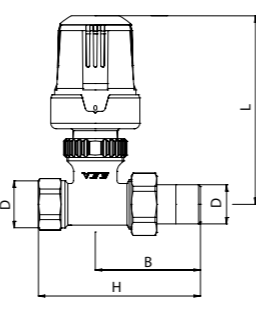

TERMOSTATİK RADYATÖR VALFLERİ (Krom)

EN 215, TS EN 215, %30'a varan Enerji Tasarrufu

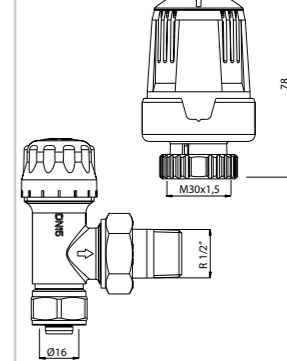
ÜRÜN	ÜRÜN KODU	ÜRÜN ADI	TEKNİK ÇİZİM	LİSTE FİYATI ₺	ÜRÜN KT. AD.														
	602 120 162	1/2" TERMOSTATİK RADYATÖR VALFİ KÖŞE Krom - TRV		185	7														
	602 120 181	3/4" TERMOSTATİK RADYATÖR VALFİ KÖŞE Krom - TRV		213	7														
		<table border="1"> <thead> <tr> <th>Ürün Kodu</th> <th>D</th> <th>L</th> <th>B</th> <th>H</th> </tr> </thead> <tbody> <tr> <td>602 120 162</td> <td>R 1/2"</td> <td>53</td> <td>23</td> <td>100.2</td> </tr> <tr> <td>602 120 181</td> <td>R 3/4"</td> <td>53</td> <td>26</td> <td>100.2</td> </tr> </tbody> </table>	Ürün Kodu	D	L	B	H	602 120 162	R 1/2"	53	23	100.2	602 120 181	R 3/4"	53	26	100.2		
Ürün Kodu	D	L	B	H															
602 120 162	R 1/2"	53	23	100.2															
602 120 181	R 3/4"	53	26	100.2															
	602 120 164	1/2" TERMOSTATİK RADYATÖR VALFİ DÜZ Krom - TRV		185	7														
	602 120 183	3/4" TERMOSTATİK RADYATÖR VALFİ DÜZ Krom - TRV		213	7														
		<table border="1"> <thead> <tr> <th>Kod No</th> <th>D</th> <th>L</th> <th>B</th> <th>H</th> </tr> </thead> <tbody> <tr> <td>602 120 164</td> <td>R 1/2"</td> <td>82</td> <td>50</td> <td>50</td> </tr> <tr> <td>602 120 183</td> <td>R 3/4"</td> <td>98</td> <td>65</td> <td>65</td> </tr> </tbody> </table>	Kod No	D	L	B	H	602 120 164	R 1/2"	82	50	50	602 120 183	R 3/4"	98	65	65		
Kod No	D	L	B	H															
602 120 164	R 1/2"	82	50	50															
602 120 183	R 3/4"	98	65	65															

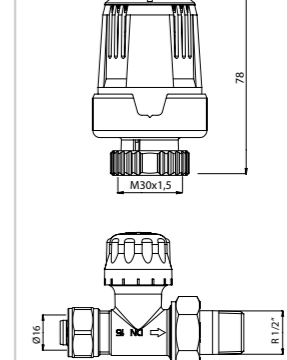
TERMOSTATİK RADYATÖR VALFLERİ (Pex Boru Bağlantılı)

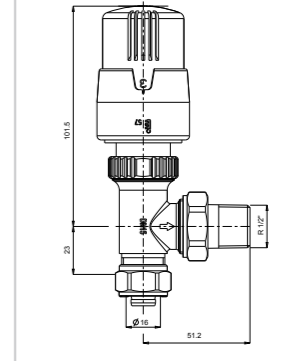
EN 215, TS EN 215, %30'a varan Enerji Tasarrufu

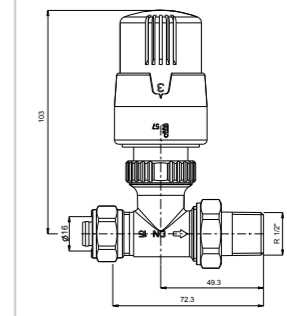
ÜRÜN	ÜRÜN KODU	ÜRÜN ADI	TEKNİK ÇİZİM	LİSTE FİYATI ₺	ÜRÜN KT. AD.
	602 120 549	TERMOSTATİK RADYATÖR VALFİ, KÖŞE (Ø 16 X 2 mm) - Pex TRV3 • 15°C Ortam Sıcaklığı Alt Limitli		116	22
	602 120 548	TERMOSTATİK RADYATÖR VALFİ, DÜZ (Ø 16 X 2 mm) - Pex TRV3 • 15°C Ortam Sıcaklığı Alt Limitli		116	22
	602 120 780	TERMOSTATİK RADYATÖR VALFİ, KÖŞE (Ø 16 X 2 mm) - Pex TRV4 • 15°C Ortam Sıcaklığı Alt Limitli		116	22
	602 120 779	TERMOSTATİK RADYATÖR VALFİ, DÜZ (Ø 16 X 2 mm) - Pex TRV4 • 15°C Ortam Sıcaklığı Alt Limitli		116	22

TERMOSTATİK RADYATÖR VALFLERİ (Kompakt Tip Panel Radyatörler İçin)

EN 215, TS EN 215, %30'a varan Enerji Tasarrufu

ÜRÜN	ÜRÜN KODU	ÜRÜN ADI	TEKNİK ÇİZİM	LİSTE FİYATI ₺	ÜRÜN KT. AD.
	602 120 326	TERMOSTATİK KOMPAKT RADYATÖR VALFİ Krom kafa - TRV + iç kompakt ventil		164	7
		<ul style="list-style-type: none"> • Dıştan contalı, uzun tip (44 mm) • Debi içi ayarlı valfi ile birlikte <p>Kullanılacak radyatör ile mutlaka ölçüsel kontrol yapınız</p>			
	602 120 540	TERMOSTATİK KOMPAKT RADYATÖR VALFİ TRV3 kafa+ iç kompakt ventil		100	7
		<ul style="list-style-type: none"> • Alından basmalı, kısa tip (35 mm) • Debi içi ayarlı valfi ile birlikte • 15°C Ortam Sıcaklığı Alt Limitli <p>Kullanılacak radyatör ile mutlaka ölçüsel kontrol yapınız</p>			
	602 120 541	TERMOSTATİK KOMPAKT RADYATÖR VALFİ TRV3 kafa+ iç kompakt ventil		100	7
		<ul style="list-style-type: none"> • Dıştan contalı, uzun tip (44 mm) • Debi içi ayarlı valfi ile birlikte • 15°C Ortam Sıcaklığı Alt Limitli <p>Kullanılacak radyatör ile mutlaka ölçüsel kontrol yapınız</p>			
	602 120 640	TERMOSTATİK KOMPAKT RADYATÖR VALFİ TRV3 kafa+ iç kompakt ventil		100	7
		<ul style="list-style-type: none"> • İçten contalı tip (41,3 mm) • Debi içi ayarlı valfi ile birlikte • 15°C Ortam Sıcaklığı Alt Limitli <p>Kullanılacak radyatör ile mutlaka ölçüsel kontrol yapınız</p>			

TERMOSTATİK RADYATÖR VALFLERİ (Kompakt Tip Panel Radyatörler İçin)

EN 215, TS EN 215, %30'a varan Enerji Tasarrufu

ÜRÜN	ÜRÜN KODU	ÜRÜN ADI	TEKNİK ÇİZİM	LİSTE FİYATI ₺	ÜRÜN KT. AD.
	602 120 796	TERMOSTATİK KOMPAKT RADYATÖR VALFİ TRV4 kafa + iç kompakt ventil		100	7
		<ul style="list-style-type: none"> • Dıştan contalı, uzun tip (44 mm) • Debi içi ayarlı valfi ile birlikte • 15°C Ortam Sıcaklığı Alt Limitli <p>Kullanılacak radyatör ile mutlaka ölçüsel kontrol yapınız</p>			
	602 120 813	TERMOSTATİK KOMPAKT RADYATÖR VALFİ TRV4 kafa + iç kompakt ventil		100	7
		<ul style="list-style-type: none"> • İçten contalı tip (41,3 mm) • Debi içi ayarlı valfi ile birlikte • 15°C Ortam Sıcaklığı Alt Limitli <p>Kullanılacak radyatör ile mutlaka ölçüsel kontrol yapınız</p>			
	602 120 814	TERMOSTATİK KOMPAKT RADYATÖR VALFİ TRV4 kafa + iç kompakt ventil		100	7
		<ul style="list-style-type: none"> • Alından basmalı, kısa tip (35 mm) • Debi içi ayarlı valfi ile birlikte • 15°C Ortam Sıcaklığı Alt Limitli <p>Kullanılacak radyatör ile mutlaka ölçüsel kontrol yapınız</p>			
	602 120 312	İÇ KOMPAKT VENTİL		44	7
		<p>YENİ</p> <ul style="list-style-type: none"> • Dıştan contalı, uzun tip (44 mm) • Debi içi ayarlı <p>Kullanılacak radyatör ile mutlaka ölçüsel kontrol yapınız</p>			

TERMOSTATİK RADYATÖR VALFLERİ (Kompakt Tip Panel Radyatörler İçin)

EN 215, TS EN 215, %30'a varan Enerji Tasarrufu

ÜRÜN	ÜRÜN KODU	ÜRÜN ADI	TEKNİK ÇİZİM	LİSTE FİYATI ₺	ÜRÜN KT. AD.
	602 120 477	İÇ KOMPAKT VENTİL • Alından basmalı, kısa tip (35 mm) • Debi içi ayarlı Kullanılacak radyatör ile mutlaka ölçüsel kontrol yapınız		71	7
	602 120 624	İÇ KOMPAKT VENTİL • İçten contalı tip (41,3 mm) • Debi içi ayarlı Kullanılacak radyatör ile mutlaka ölçüsel kontrol yapınız		50	7
	602 120 736	İÇ KOMPAKT VENTİL • Dıştan contalı tip (55 mm) • Debi içi ayarlı • Özel dizayn alüminyum radyatör modelleri için uygundur. Kullanılacak radyatör ile mutlaka ölçüsel kontrol yapınız		69	7
	602 120 737	İÇ KOMPAKT VENTİL • Dıştan contalı tip (87 mm) • Debi içi ayarlı • Özel dizayn alüminyum radyatör modelleri için uygundur. Kullanılacak radyatör ile mutlaka ölçüsel kontrol yapınız		82	7

TERMOSTATİK RADYATÖR VALFLERİ (Debi İç Ayar Tertibatlı)

EN 215, TS EN 215, %30'a varan Enerji Tasarrufu

ÜRÜN	ÜRÜN KODU	ÜRÜN ADI	TEKNİK ÇİZİM	LİSTE FİYATI ₺	ÜRÜN KT. AD.
	802 120 007	1/2'' TERMOSTATİK RADYATÖR VALFİ, DÜZ TRV4 • Debi ayar tertibatlı		183	7
	802 120 006	1/2'' TERMOSTATİK RADYATÖR VALFİ, KÖŞE TRV4 • Debi ayar tertibatlı		183	7
	602 120 257*	1/2'' TERMOSTATİK RADYATÖR VALFİ, DÜZ Krom - TRV • Debi ayar tertibatlı		201	7
	602 120 259*	1/2'' TERMOSTATİK RADYATÖR VALFİ, KÖŞE Krom - TRV • Debi ayar tertibatlı		201	7

* İlgili ürünler sipariş bazında özel üretilir.





• Fiyatlara KDV ayrıca dahil edilir. Tavsiye edilen bayi satış fiyatıdır.
SİRKÜLER NO: S2120101

10 • Standart belgelerine ve belgelendirme kapsamındaki ürünlere www.eca.com.tr, www.valf.com.tr üzerinden ulaşılabilir.
• Katalogda yer alan resimler bilgi içindir. Elmor Tesisat Malzemeleri Tic. A.Ş. mamul fiyat ve görünüş detaylarında değişiklik yapma hakkına sahiptir.

TERMOSTATİK RADYATÖR VALFLERİ (Kafa Grupları) EN 215, TS EN 215, %30'a varan Enerji Tasarrufu

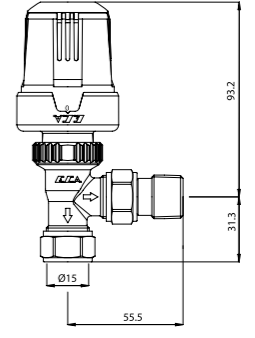
ÜRÜN	ÜRÜN KODU	ÜRÜN ADI	TEKNİK ÇİZİM	LİSTE FİYATI ₺	ÜRÜN KT. AD.
	602 120 530	TERMOSTAT KAFA GRUBU TRV3 • 15°C Ortam Sıcaklığı Alt Limitli		76	14
	602 120 170	TERMOSTAT KAFA GRUBU Krom - TRV		141	14
	602 120 754	TERMOSTAT KAFA GRUBU TRV4 • 15°C Ortam Sıcaklığı Alt Limitli		76	24

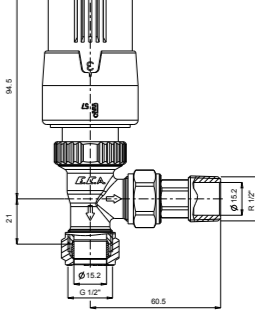
TERMOSTATİK RADYATÖR VALFLERİ (çift akış yönlü tipler) EN 215, TS EN 215, %30'a varan Enerji Tasarrufu

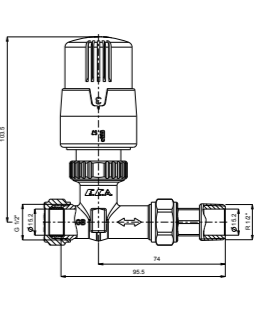
ÜRÜN	ÜRÜN KODU	ÜRÜN ADI	TEKNİK ÇİZİM	LİSTE FİYATI ₺	ÜRÜN KT. AD.
	602 120 166*	1/2" TERMOSTATİK RADYATÖR VALFİ Krom - TRV • Çift akış yönlü kullanılabilir, • Giriş çapı Ø 15 mm.		238	7
	602 120 759*	1/2" TERMOSTATİK RADYATÖR VALFİ TRV4 • Çift akış yönlü kullanılabilir, • Giriş çapı Ø 15 mm. Bakır boru • 15°C Ortam Sıcaklığı Alt Limitli		140	22
	602 120 760*	1/2" TERMOSTATİK RADYATÖR VALFİ TRV4 • Çift akış yönlü kullanılabilir, • Giriş çapı Ø 15 mm. Bakır boru • 15°C Ortam Sıcaklığı Alt Limitli		152	22

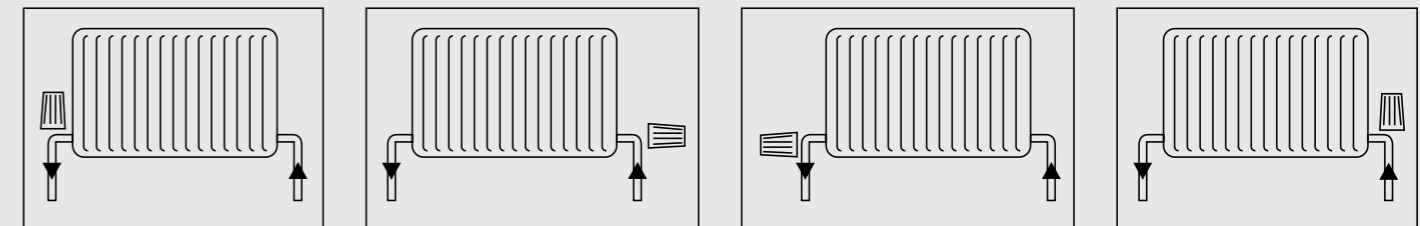









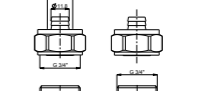

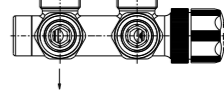
* İlgili ürünler sipariş bazında özel üretilir.

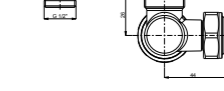
• Fiyatlara KDV ayrıca dahil edilir. Tavsiye edilen bayi satış fiyatıdır.
SİRKÜLER NO: S2120101

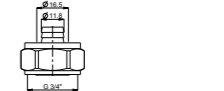

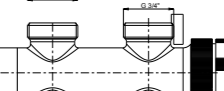
TERMOSTATİK RADYATÖR VALFLERİ (H-Tip) EN 215, TS EN 215, %30'a varan Enerji Tasarrufu

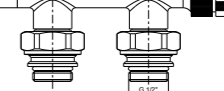
ÜRÜN	ÜRÜN KODU	ÜRÜN ADI	TEKNİK ÇİZİM	LİSTE FİYATI ₺	ÜRÜN KT. AD.
	602 120 843	TERMOSTATİK H-VALF, KÖŞE, NİKEL (Ø 16 x 2 mm Pex), TRV4		452	6
	802 120 010	TERMOSTATİK H-VALF, KÖŞE, NİKEL (Ø 16 x 2 mm Pex) TRV3		452	6
	802 120 011	TERMOSTATİK H-VALF, KÖŞE, NİKEL (Ø 16 x 2 mm Pex) TRV Krom		452	6
	602 120 836	TERMOSTATİK H-VALF, DÜZ, NİKEL (Ø 16 x 2 mm Pex) TRV4		459	6
	802 120 012	TERMOSTATİK H-VALF, DÜZ, NİKEL (Ø 16 x 2 mm Pex) TRV3		459	6
	802 120 013	TERMOSTATİK H-VALF, DÜZ, NİKEL (Ø 16 x 2 mm Pex) TRV Krom		459	6



**TASARRUFU
ŞIKLIKLA KOMBİNLEDİK**

Farklı renklerde dekoratif kapağıyla
ECA H-TRV



TERMOSTATİK RADYATÖR VALFLERİ (H-Tip) EN 215, TS EN 215, %30'a varan Enerji Tasarrufu

ÜRÜN	ÜRÜN KODU	ÜRÜN ADI	TEKNİK ÇİZİM	LİSTE FİYATI ₺	ÜRÜN KT. AD.
	610 801 227	H-TRV DEKORATİF KAPAK, KROM		79	5
	610 801 226	H-TRV DEKORATİF KAPAK, BEYAZ		17	5
	610 801 225	H-TRV DEKORATİF KAPAK, SİYAH		17	5







Görseller temsildir. Kapaklara vana dahil değildir.

*** Sadece siparişe özel imalat yapılabilir.

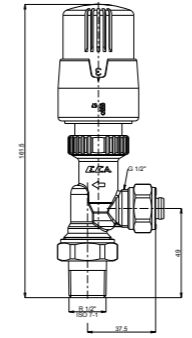
• Fiyatlara KDV ayrıca dahil edilir. Tavsiye edilen bayi satış fiyatıdır.
SİRKÜLER NO: S2120101

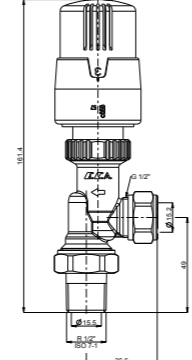
TERMOSTATİK RADYATÖR VALFLERİ (Yatay Eksenli)

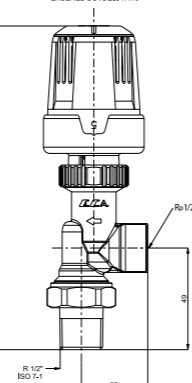
EN 215, TS EN 215, %30'a varan Enerji Tasarrufu

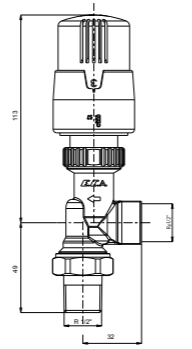
ÜRÜN	ÜRÜN KODU	ÜRÜN ADI	TEKNİK ÇİZİM	LİSTE FİYATI ₺	ÜRÜN KT. AD.
	602 120 879	1/2" YATAY EKSENLİ TERMOSTATİK RADYATÖR VALFİ Ø16x2mm Pex, TRV4 • 15°C Ortam Sıcaklığı Alt Limitli		146	22
	602 120 880	1/2" YATAY EKSENLİ TERMOSTATİK RADYATÖR VALFİ Ø15 Bakır Boru, TRV4 • 15°C Ortam Sıcaklığı Alt Limitli		144	22
	602 120 528*	1/2" YATAY EKSENLİ TERMOSTATİK RADYATÖR VALFİ TRV3 • 15°C Ortam Sıcaklığı Alt Limitli		133	22
	602 120 815*	1/2" YATAY EKSENLİ TERMOSTATİK RADYATÖR VALFİ TRV4 • 15°C Ortam Sıcaklığı Alt Limitli		133	22

* İlgili ürünler sipariş bazında özel üretilir.

RADYATÖR VALFLERİ





ÜRÜN	ÜRÜN KODU	ÜRÜN ADI	TEKNİK ÇİZİM	LİSTE FİYATI ₺	ÜRÜN KT. AD.
	102 120 332	1/2" RV2 KÖŞE RADYATÖR VALFİ		57	50
	102 120 333	3/4" RV2 KÖŞE RADYATÖR VALFİ		85	35
	102 120 322	1/2" RV2 DÜZ RADYATÖR VALFİ		65	50
	102 120 323	3/4" RV2 DÜZ RADYATÖR VALFİ		91	35
	602 120 338	KÖŞE RADYATÖR VALFİ (Ø 16 x 2 mm) Pex RV2		74	50
		• Sıcak Sulu Isıtma sistemleri, 10bar, 120°C			
	602 120 552	1/2" RV2 KÖŞE RADYATÖR VALFİ CANTALI		68	50
		• TS 579 • Sıcak Sulu Isıtma sistemleri, 10bar, 120°C			

• Fiyatlara KDV ayrıca dahil edilir. Tavsiye edilen bayi satış fiyatıdır.
SİRKÜLER NO: S2120101

RADYATÖR VALFLERİ

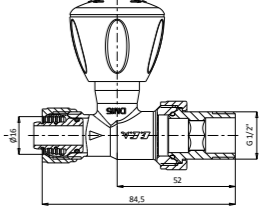
ÜRÜN	ÜRÜN KODU	ÜRÜN ADI	TEKNİK ÇİZİM	LİSTE FİYATI ₺	ÜRÜN KT. AD.
	602 120 553	1/2" RV2 DÜZ RADYATÖR VALFİ CONTALI • TS 579 • Sıcak Sulu Isıtma sistemleri, 10bar, 120°C		75	50
	602 120 641	1/2" RV3 KÖŞE RADYATÖR VALFİ • TS 579 • Sıcak Sulu Isıtma sistemleri, 10bar, 120°C		46	50
	602 120 725	1/2" RV3 DÜZ RADYATÖR VALFİ • TS 579 • Sıcak Sulu Isıtma sistemleri, 10bar, 120°C		51	50
	602 120 721	RV3 KÖŞE RADYATÖR VALFİ (Ø 16 x 2 mm) - Pex RV3 • Sıcak Sulu Isıtma sistemleri, 10bar, 120°C		51	50

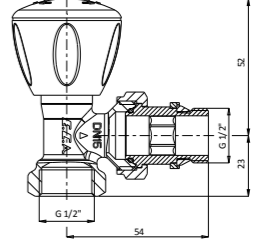

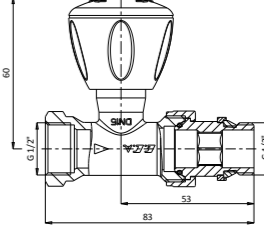
RADYATÖR VALFLERİ

ÜRÜN	ÜRÜN KODU	ÜRÜN ADI	TEKNİK ÇİZİM	LİSTE FİYATI ₺	ÜRÜN KT. AD.
	602 120 722	RV3 DÜZ RADYATÖR VALFİ (Ø 16 x 2 mm) - Pex RV3 • Sıcak Sulu Isıtma sistemleri, 10bar, 120°C		53	50
	602 120 723	1/2" RV3 KÖŞE RADYATÖR VALFİ - CONTALI • TS 579 • Sıcak Sulu Isıtma sistemleri, 10bar, 120°C		51	50
	602 120 724	1/2" RV3 DÜZ RADYATÖR VALFİ - CONTALI • TS 579 • Sıcak Sulu Isıtma sistemleri, 10bar, 120°C		53	50

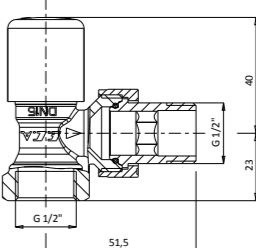

KROM RADYATÖR VALFLERİ (Havlupan Tipi Radyatörler İçin)

ÜRÜN	ÜRÜN KODU	ÜRÜN ADI	TEKNİK ÇİZİM	LİSTE FİYATI ₺	ÜRÜN KT. AD.
	602 120 749	1/2" RV3 KROM KÖŞE RADYATÖR VALFİ • TS 579 • Sıcak Sulu Isıtma sistemleri, 10bar, 120°C • Krom kaplama		69	50
	602 120 750	1/2" RV3 KROM DÜZ RADYATÖR VALFİ • TS 579 • Sıcak Sulu Isıtma sistemleri, 10bar, 120°C • Krom kaplama		77	50
	602 120 751	1/2" RV3 KROM KÖŞE RADYATÖR VALFİ (Ø16 X 2 mm) - Pex • Sıcak Sulu Isıtma sistemleri, 10bar, 120°C • Krom kaplama		85	50
	602 120 752	1/2" RV3 KROM DÜZ RADYATÖR VALFİ (Ø16 X 2 mm) - Pex • Sıcak Sulu Isıtma sistemleri, 10bar, 120°C • Krom kaplama		92	50

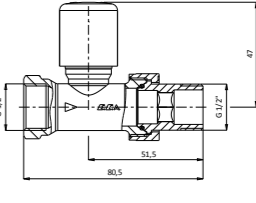
KROM RADYATÖR VALFLERİ (Havlupan Tipi Radyatörler İçin)

ÜRÜN	ÜRÜN KODU	ÜRÜN ADI	TEKNİK ÇİZİM	LİSTE FİYATI ₺	ÜRÜN KT. AD.
	602 120 280	1/2" KROM, VOLANLI KÖŞE RADYATÖR VALFİ • TS 579 • Sıcak Sulu Isıtma sistemleri, 10bar, 120°C • Krom kaplama		65	50
	602 120 281	1/2" KROM, VOLANLI DÜZ RADYATÖR VALFİ • TS 579 • Sıcak Sulu Isıtma sistemleri, 10bar, 120°C • Krom kaplama		70	50

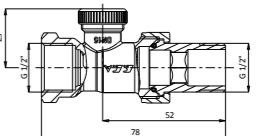

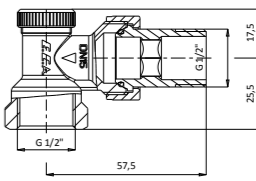



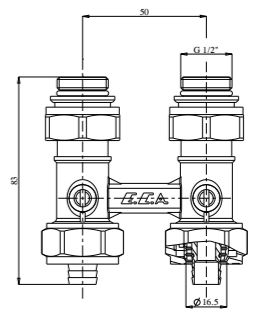

RADYATÖR GERİ DÖNÜŞ VALFLERİ

ÜRÜN	ÜRÜN KODU	ÜRÜN ADI	TEKNİK ÇİZİM	LİSTE FİYATI ₺	ÜRÜN KT. AD.
	602 120 727	1/2" - GV3 DÜZ RADYATÖR DÖNÜŞ VALFİ Nikel • TS 579 • Sıcak Sulu Isıtma sistemleri, 10bar, 120°C		52	30
	602 120 726	1/2" - GV3 KÖŞE RADYATÖR DÖNÜŞ VALFİ Nikel • TS 579 • Sıcak Sulu Isıtma sistemleri, 10bar, 120°C		51	40

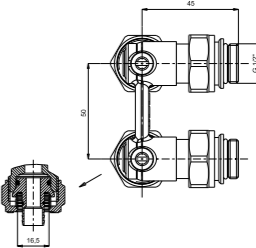

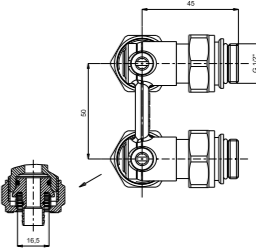

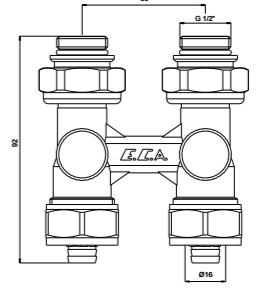
RADYATÖR GERİ DÖNÜŞ VALFLERİ

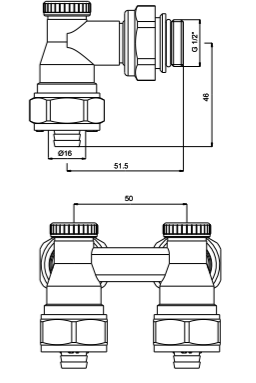
ÜRÜN	ÜRÜN KODU	ÜRÜN ADI	TEKNİK ÇİZİM	LİSTE FİYATI ₺	ÜRÜN KT. AD.
	602 120 731	DÜZ RADYATÖR DÖNÜŞ VALFİ (Ø 16 x 2 mm) - Pex GV3 - GERİ DÖNÜŞ VALFİ • Sıcak Sulu Isıtma sistemleri, 10bar, 120°C		60	30
	602 120 730	KÖŞE RADYATÖR DÖNÜŞ VALFİ (Ø 16 x 2 mm) - Pex GV3 - GERİ DÖNÜŞ VALFİ • Sıcak Sulu Isıtma sistemleri, 10bar, 120°C		53	40
	602 120 728	1/2\"		53	40
	602 120 729	1/2\"		60	30



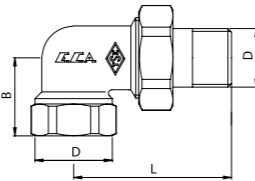

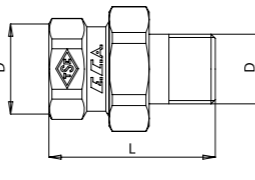

H-VALFLER (kompakt tip panel radyatörler için)

ÜRÜN	ÜRÜN KODU	ÜRÜN ADI	TEKNİK ÇİZİM	LİSTE FİYATI ₺	ÜRÜN KT. AD.
	602 120 331	1/2\"		139	7
	602 120 743	1/2\"		162	7
	602 120 333	1/2\"		146	7
	602 120 348	1/2\"		156	7
	602 120 349	1/2\"		161	7

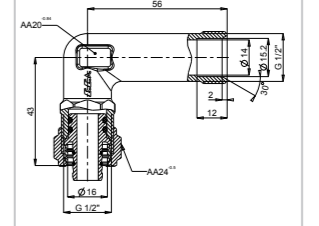
RAKORLAR

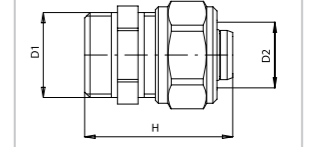
ÜRÜN	ÜRÜN KODU	ÜRÜN ADI	TEKNİK ÇİZİM	LİSTE FİYATI ₺	ÜRÜN KT. AD.																		
	601 002 001	3/8" KÖŞE RAKOR		34	100																		
	601 002 002	1/2" KÖŞE RAKOR		34	80																		
	601 002 003	3/4" KÖŞE RAKOR		48	40																		
	601 002 004	1" KÖŞE RAKOR		75	25																		
	601 002 005	1 1/4" KÖŞE RAKOR		138	15																		
	602 121 001	3/8" KÖŞE RAKOR, NİKEL KAPLAMALI	<table border="1"> <thead> <tr> <th>D</th> <th>L</th> <th>D1</th> </tr> </thead> <tbody> <tr> <td>G 3/8"</td> <td>50</td> <td>22</td> </tr> <tr> <td>1/2"</td> <td>56</td> <td>26</td> </tr> <tr> <td>3/4"</td> <td>64</td> <td>29</td> </tr> <tr> <td>G 1"</td> <td>72</td> <td>34</td> </tr> <tr> <td>G1 1/4"</td> <td>81.5</td> <td>42</td> </tr> </tbody> </table>	D	L	D1	G 3/8"	50	22	1/2"	56	26	3/4"	64	29	G 1"	72	34	G1 1/4"	81.5	42	39	100
	D	L		D1																			
	G 3/8"	50		22																			
	1/2"	56		26																			
	3/4"	64		29																			
G 1"	72	34																					
G1 1/4"	81.5	42																					
602 121 002	1/2" KÖŞE RAKOR, NİKEL KAPLAMALI	39	80																				
602 121 003	3/4" KÖŞE RAKOR, NİKEL KAPLAMALI	62	40																				
602 121 004	1" KÖŞE RAKOR, NİKEL KAPLAMALI	98	25																				
602 121 005	1 1/4" KÖŞE RAKOR, NİKEL KAPLAMALI	155	15																				
		<ul style="list-style-type: none"> • TS 579 • Sıcak Sulu Isıtma sistemleri, 10 bar, 120°C 																					
	601 002 006	3/8" DÜZ RAKOR		27	125																		
	601 002 007	1/2" DÜZ RAKOR		27	100																		
	601 002 008	3/4" DÜZ RAKOR		39	70																		
	601 002 009	1" DÜZ RAKOR		62	40																		
	601 002 010	1 1/4" DÜZ RAKOR		125	25																		
	602 121 006	3/8" DÜZ RAKOR, NİKEL KAPLAMALI	<table border="1"> <thead> <tr> <th>D</th> <th>L</th> </tr> </thead> <tbody> <tr> <td>G 3/8"</td> <td>50</td> </tr> <tr> <td>1/2"</td> <td>56</td> </tr> <tr> <td>3/4"</td> <td>64</td> </tr> <tr> <td>G 1"</td> <td>72</td> </tr> <tr> <td>G1 1/4"</td> <td>81.5</td> </tr> </tbody> </table>	D	L	G 3/8"	50	1/2"	56	3/4"	64	G 1"	72	G1 1/4"	81.5	27	125						
	D	L																					
	G 3/8"	50																					
	1/2"	56																					
	3/4"	64																					
G 1"	72																						
G1 1/4"	81.5																						
602 121 007	1/2" DÜZ RAKOR, NİKEL KAPLAMALI	27	100																				
602 121 008	3/4" DÜZ RAKOR, NİKEL KAPLAMALI	46	70																				
602 121 009	1" DÜZ RAKOR, NİKEL KAPLAMALI	81	40																				
602 121 010	1 1/4" DÜZ RAKOR, NİKEL KAPLAMALI	138	25																				
		<ul style="list-style-type: none"> • TS 579 • Sıcak Sulu Isıtma sistemleri, 10 bar, 120°C 																					

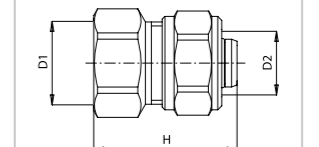

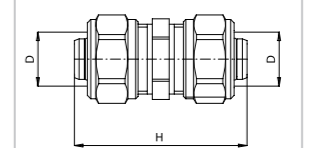
PEX BORU BAĞLANTI ELEMANLARI

ÜRÜN	ÜRÜN KODU	ÜRÜN ADI	TEKNİK ÇİZİM	LİSTE FİYATI ₺	ÜRÜN KT. AD.														
	602 499 181	1/2" X Ø16 MM RADYATÖR BAĞLANTI DİRSEĞİ		42	20														
		<ul style="list-style-type: none"> • Sıcak Sulu Isıtma sistemleri, 10bar, 120°C 																	
	602 199 272	1/2" x Ø16 mm DÜZ RAKOR DIŞ VİDA		23	150														
				<table border="1"> <thead> <tr> <th>D1</th> <th>D2</th> <th>H</th> </tr> </thead> <tbody> <tr> <td>1/2"</td> <td>16</td> <td>36.1</td> </tr> <tr> <td>1/2"</td> <td>20</td> <td>44</td> </tr> <tr> <td>G 3/8"</td> <td>16</td> <td>35.1</td> </tr> <tr> <td>G 3/8"</td> <td>20</td> <td>46</td> </tr> </tbody> </table>	D1	D2	H	1/2"	16	36.1	1/2"	20	44	G 3/8"	16	35.1	G 3/8"	20	46
D1	D2	H																	
1/2"	16	36.1																	
1/2"	20	44																	
G 3/8"	16	35.1																	
G 3/8"	20	46																	
	602 199 273	1/2" x Ø16 mm DÜZ RAKOR İÇ VİDA		25	200														
				<table border="1"> <thead> <tr> <th>D1</th> <th>D2</th> <th>H</th> </tr> </thead> <tbody> <tr> <td>1/2"</td> <td>16</td> <td>36</td> </tr> <tr> <td>1/2"</td> <td>20</td> <td>36</td> </tr> <tr> <td>3/4"</td> <td>20</td> <td>45</td> </tr> </tbody> </table>	D1	D2	H	1/2"	16	36	1/2"	20	36	3/4"	20	45			
D1	D2	H																	
1/2"	16	36																	
1/2"	20	36																	
3/4"	20	45																	
	602 199 274	Ø16 x Ø16 mm DÜZ RAKOR PEX BORU BAĞLANTILI		39	150														
				<table border="1"> <thead> <tr> <th>D1</th> <th>D2</th> <th>H</th> </tr> </thead> <tbody> <tr> <td>16</td> <td>16</td> <td>51</td> </tr> <tr> <td>20</td> <td>20</td> <td>51.2</td> </tr> </tbody> </table>	D1	D2	H	16	16	51	20	20	51.2						
D1	D2	H																	
16	16	51																	
20	20	51.2																	

OTOMATİK HAVALANDIRICILAR

ÜRÜN	ÜRÜN KODU	ÜRÜN ADI	TEKNİK ÇİZİM	LİSTE FİYATI ₺	ÜRÜN KT. AD.
	102 109 139	3/8" OTOMATİK HAVALANDIRICI (Çekvalfli)		108	40
	102 109 134	1/2" OTOMATİK HAVALANDIRICI (Çekvalfli)		111	40
		TS 7817 • Sıcak Sulu Isıtma Sistemleri, 10bar, 110°C			
	602 109 013	3/8" OTOMATİK HAVALANDIRICI (Çekvalfsiz)		91	40
	602 109 051	1/2" OTOMATİK HAVALANDIRICI (Çekvalfsiz)		85	40
		TS 7817 • Sıcak Sulu Isıtma Sistemleri, 10bar, 110°C			
	602 109 033	3/8" OTOMATİK HAVALANDIRICI - KÖŞE (Çekvalfli)		114	45
	602 109 034	1/2" OTOMATİK HAVALANDIRICI - KÖŞE (Çekvalfli)		117	45
		TS 7817 • Sıcak Sulu Isıtma Sistemleri, 10bar, 110°C			
	602 109 037	3/8" OTOMATİK HAVALANDIRICI - KÖŞE (Çekvalfsiz)		96	45
	602 109 052	1/2" OTOMATİK HAVALANDIRICI - KÖŞE (Çekvalfsiz)		88	45
		TS 7817 • Sıcak Sulu Isıtma Sistemleri, 10bar, 110°C			

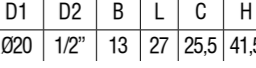
EMNİYET VALFLERİ GÜNEŞ ENERJİSİ SİSTEMLERİ EMNİYET VALFİ

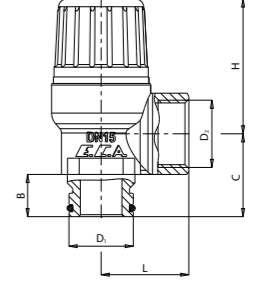
ÜRÜN	ÜRÜN KODU	ÜRÜN ADI	TEKNİK ÇİZİM	LİSTE FİYATI ₺	ÜRÜN KT. AD.
	602 111 033	GÜNEŞ ENERJİSİ EMNİYET VALFİ, Ø20 O-RİNGLİ 1/2" İÇ VİDA		51	50
	602 111 034	GÜNEŞ ENERJİSİ EMNİYET VALFİ, 1/2" İÇ/DIŞ VİDA		51	50
	602 111 035	GÜNEŞ ENERJİSİ EMNİYET VALFİ, 1/2" İÇ VİDA		51	50
		• TS EN 4126-1 • 3 bar ayar basıncı			

SU TESİSAT/KOMBİ EMNİYET VALFİ

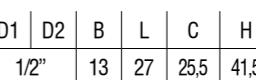
ÜRÜN	ÜRÜN KODU	ÜRÜN ADI	TEKNİK ÇİZİM	LİSTE FİYATI ₺	ÜRÜN KT. AD.
	602 111 031	KOMBİ EMNİYET VALFİ, 1/2" İÇ/DIŞ VİDA		51	50
	602 111 032	KOMBİ EMNİYET VALFİ, 1/2" İÇ VİDA		51	50
		• TS EN 4126-1 • 3 bar ayar basıncı			

DOĞALGAZ KÜRESEL VALFLERİ - MOP 0.5 (Bina İçi Doğalgaz Tesisatları için)

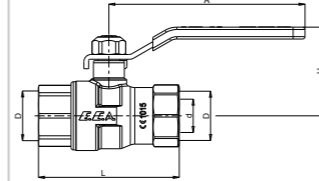
ÜRÜN	ÜRÜN KODU	ÜRÜN ADI	TEKNİK ÇİZİM	LİSTE FİYATI ₺	ÜRÜN KT. AD.
	602 122 151	1/2" DOĞALGAZ KÜRESEL VALFİ		46	24
	602 122 152	3/4" DOĞALGAZ KÜRESEL VALFİ		56	12
	602 122 153	1" DOĞALGAZ KÜRESEL VALFİ		91	15
	602 122 154	1 1/4" DOĞALGAZ KÜRESEL VALFİ		199	8
	602 122 155	1 1/2" DOĞALGAZ KÜRESEL VALFİ		265	6
	602 122 156	2" DOĞALGAZ KÜRESEL VALFİ		407	3
		<ul style="list-style-type: none"> EN331-A1 CE belgelidir. Bina içi doğalgaz tesisatlarında kullanımı uygundur. 			

D	d	L	A	H
Rp 1/2"	14	59.2	82.5	37.3
Rp 3/4"	19	68.2	82.5	40.7
Rp 1"	24	83	100	47.5
Rp1 1/4"	30	97	154.5	64.3
Rp1 1/2"	38	103	154.5	69.3
Rp 2"	47	127	185	79.5

KİLİTLEMELİ DOĞALGAZ KÜRESEL VALFLERİ - MOP 0.5 (Bina İçi Doğalgaz Tesisatları için)

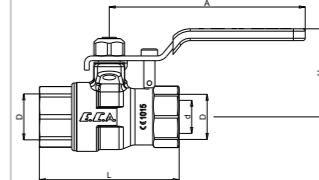
ÜRÜN	ÜRÜN KODU	ÜRÜN ADI	TEKNİK ÇİZİM	LİSTE FİYATI ₺	ÜRÜN KT. AD.
	602 122 175	1/2" KİLİTLEMELİ DOĞALGAZ KÜRESEL VALF		51	24
	602 122 176	3/4" KİLİTLEMELİ DOĞALGAZ KÜRESEL VALF		64	12
	602 122 177	1" KİLİTLEMELİ DOĞALGAZ KÜRESEL VALF		103	15
		<ul style="list-style-type: none"> EN331-A1 CE belgelidir. Bina içi doğalgaz tesisatlarında kullanımı uygundur. 			

D	d	L	A	H
Rp 1/2"	14	59.2	83	37.3
Rp 3/4"	19	68.2	83	40.7
Rp 1"	24	83	100	47.5

DOĞALGAZ KÜRESEL VALFLERİ - MOP 5 (Bina Dışı Doğalgaz Tesisatları için)

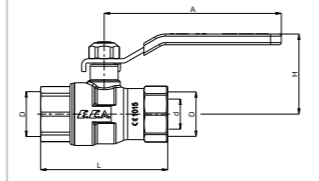
ÜRÜN	ÜRÜN KODU	ÜRÜN ADI	TEKNİK ÇİZİM	LİSTE FİYATI ₺	ÜRÜN KT. AD.
	602 122 205	1/2" DOĞALGAZ KÜRESEL VALFİ		44	24
	602 122 206	3/4" DOĞALGAZ KÜRESEL VALFİ		53	12
	602 122 207	1" DOĞALGAZ KÜRESEL VALFİ		88	15
	602 122 208	1 1/4" DOĞALGAZ KÜRESEL VALFİ		194	8
	602 122 209	1 1/2" DOĞALGAZ KÜRESEL VALFİ		257	6
	602 122 210	2" DOĞALGAZ KÜRESEL VALFİ		395	3
		<ul style="list-style-type: none"> EN331'e uygundur. Bina dışı doğalgaz tesisatlarında kullanımı uygundur. 			

D	d	L	A	H
Rp 1/2"	14	59.2	82.5	37.3
Rp 3/4"	19	68.2	82.5	40.7
Rp 1"	24	83	100	47.5
Rp1 1/4"	30	97	154.5	64.3
Rp1 1/2"	38	103	154.5	69.3
Rp 2"	47	127	185	79.5

İÇME SUYU KÜRESEL VALFLERİ - PN10

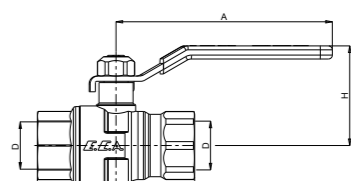
ÜRÜN	ÜRÜN KODU	ÜRÜN ADI	TEKNİK ÇİZİM	LİSTE FİYATI ₺	ÜRÜN KT. AD.
	602 122 168	1/2" İÇME SUYU KÜRESEL VALFİ İÇ VE İÇ VİDA - TAM GEÇİŞLİ		46	24
	602 122 169	3/4" İÇME SUYU KÜRESEL VALFİ İÇ VE İÇ VİDA - TAM GEÇİŞLİ		62	12
	602 122 170	1" İÇME SUYU KÜRESEL VALFİ İÇ VE İÇ VİDA - TAM GEÇİŞLİ		99	15
	602 122 182	1 1/4" İÇME SUYU KÜRESEL VALFİ İÇ VE İÇ VİDA - TAM GEÇİŞLİ		231	8
	602 122 183	1 1/2" İÇME SUYU KÜRESEL VALFİ İÇ VE İÇ VİDA - TAM GEÇİŞLİ		308	6
	602 122 184	2" İÇME SUYU KÜRESEL VALFİ İÇ VE İÇ VİDA - TAM GEÇİŞLİ		485	3
		<ul style="list-style-type: none"> TS EN 13828 Çalışma sıcaklık Aralığı: -30°C +80°C 			

D	d	L	A	H
Rp 1/2"	Ø15	60	83	38
Rp 3/4"	Ø20	68.5	83	41.2
Rp 1"	Ø25	83	100	47.5
Rp1 1/4"	Ø32	96.1	154.5	64.3
Rp1 1/2"	Ø40	109	154.5	71.25
Rp 2"	Ø50	129	185	81.65

ENDÜSTRİYEL TİP KÜRESEL VALFLER-PN25

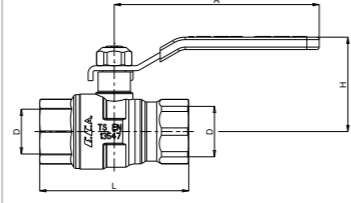
ÜRÜN	ÜRÜN KODU	ÜRÜN ADI	TEKNİK ÇİZİM	LİSTE FİYATI ₺	ÜRÜN KT. AD.																																												
	602 122 187	1/2" ENDÜSTRİYEL TİP KÜRESEL VALF İÇ VE İÇ VIDA - TAM GEÇİŞLİ		62	24																																												
	602 122 188	3/4" ENDÜSTRİYEL TİP KÜRESEL VALF İÇ VE İÇ VIDA - TAM GEÇİŞLİ		75	12																																												
	602 122 189	1" ENDÜSTRİYEL TİP KÜRESEL VALF İÇ VE İÇ VIDA - TAM GEÇİŞLİ		117	15																																												
	602 122 202	1 1/4" ENDÜSTRİYEL TİP KÜRESEL VALF İÇ VE İÇ VIDA - TAM GEÇİŞLİ		251	8																																												
	602 122 203	1 1/2" ENDÜSTRİYEL TİP KÜRESEL VALF İÇ VE İÇ VIDA - TAM GEÇİŞLİ		326	6																																												
	602 122 204	2" ENDÜSTRİYEL TİP KÜRESEL VALF İÇ VE İÇ VIDA - TAM GEÇİŞLİ		575	3																																												
	602 122 235	2 1/2" ENDÜSTRİYEL TİP KÜRESEL VALF İÇ VE İÇ VIDA - TAM GEÇİŞLİ		1.477	2																																												
	602 122 236	3" ENDÜSTRİYEL TİP KÜRESEL VALF İÇ VE İÇ VIDA - TAM GEÇİŞLİ		2.470	1																																												
		• TS CEN TS 13547 • Çalışma sıcaklık Aralığı: -30°C +80°C																																															
		<table border="1"> <thead> <tr> <th>D</th> <th>d</th> <th>L</th> <th>A</th> <th>H</th> </tr> </thead> <tbody> <tr> <td>Rp 1/2"</td> <td>Ø 15</td> <td>60</td> <td>83</td> <td>38</td> </tr> <tr> <td>Rp 3/4"</td> <td>Ø 20</td> <td>68,5</td> <td>83</td> <td>41,2</td> </tr> <tr> <td>Rp 1"</td> <td>Ø 25</td> <td>83</td> <td>100</td> <td>47,5</td> </tr> <tr> <td>Rp 1 1/4"</td> <td>Ø 32</td> <td>96,1</td> <td>154,5</td> <td>64,3</td> </tr> <tr> <td>Rp 1 1/2"</td> <td>Ø 40</td> <td>109</td> <td>154,5</td> <td>71,25</td> </tr> <tr> <td>Rp 2"</td> <td>Ø 50</td> <td>129</td> <td>185</td> <td>81,65</td> </tr> <tr> <td>Rp 2 1/2"</td> <td>Ø 64</td> <td>150,6</td> <td>249,3</td> <td>112,8</td> </tr> <tr> <td>Rp 2"</td> <td>Ø 76</td> <td>165</td> <td>249,3</td> <td>123,8</td> </tr> </tbody> </table>		D	d	L	A	H	Rp 1/2"	Ø 15	60	83	38	Rp 3/4"	Ø 20	68,5	83	41,2	Rp 1"	Ø 25	83	100	47,5	Rp 1 1/4"	Ø 32	96,1	154,5	64,3	Rp 1 1/2"	Ø 40	109	154,5	71,25	Rp 2"	Ø 50	129	185	81,65	Rp 2 1/2"	Ø 64	150,6	249,3	112,8	Rp 2"	Ø 76	165	249,3	123,8	
D	d	L	A	H																																													
Rp 1/2"	Ø 15	60	83	38																																													
Rp 3/4"	Ø 20	68,5	83	41,2																																													
Rp 1"	Ø 25	83	100	47,5																																													
Rp 1 1/4"	Ø 32	96,1	154,5	64,3																																													
Rp 1 1/2"	Ø 40	109	154,5	71,25																																													
Rp 2"	Ø 50	129	185	81,65																																													
Rp 2 1/2"	Ø 64	150,6	249,3	112,8																																													
Rp 2"	Ø 76	165	249,3	123,8																																													



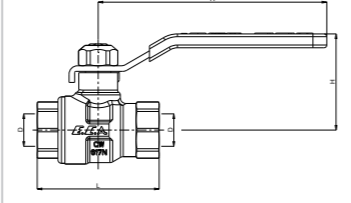

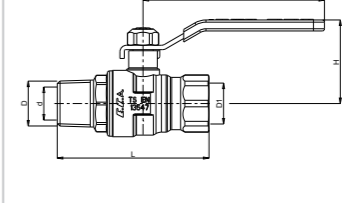

ENDÜSTRİYEL TİP KÜRESEL VALFLER-PN40

ÜRÜN	ÜRÜN KODU	ÜRÜN ADI	TEKNİK ÇİZİM	LİSTE FİYATI ₺	ÜRÜN KT. AD.																													
	602 122 228	1/4" ENDÜSTRİYEL TİP KÜRESEL VALF İÇ VE İÇ VIDA - TAM GEÇİŞLİ		75	24																													
	602 122 229	3/8" ENDÜSTRİYEL TİP KÜRESEL VALF İÇ VE İÇ VIDA - TAM GEÇİŞLİ		75	24																													
	602 122 230	1/2" ENDÜSTRİYEL TİP KÜRESEL VALF İÇ VE İÇ VIDA - TAM GEÇİŞLİ		77	24																													
	602 122 231	3/4" ENDÜSTRİYEL TİP KÜRESEL VALF İÇ VE İÇ VIDA - TAM GEÇİŞLİ		96	12																													
	602 122 232	1" ENDÜSTRİYEL TİP KÜRESEL VALF İÇ VE İÇ VIDA - TAM GEÇİŞLİ		148	15																													
		• TS CEN TS 13547 • Çalışma sıcaklık Aralığı: -30°C +80°C																																
		<table border="1"> <thead> <tr> <th>D</th> <th>d</th> <th>L</th> <th>A</th> <th>H</th> </tr> </thead> <tbody> <tr> <td>G 1/4"</td> <td>Ø 10</td> <td>44</td> <td>83</td> <td>35,3</td> </tr> <tr> <td>G 3/8"</td> <td>Ø 11</td> <td>46</td> <td>83</td> <td>36</td> </tr> <tr> <td>1/2"</td> <td>Ø 14</td> <td>50</td> <td>83</td> <td>37</td> </tr> <tr> <td>3/4"</td> <td>Ø 19</td> <td>58</td> <td>83</td> <td>40,5</td> </tr> <tr> <td>G 1"</td> <td>Ø 24</td> <td>71</td> <td>100</td> <td>46,5</td> </tr> </tbody> </table>	D	d	L	A	H	G 1/4"	Ø 10	44	83	35,3	G 3/8"	Ø 11	46	83	36	1/2"	Ø 14	50	83	37	3/4"	Ø 19	58	83	40,5	G 1"	Ø 24	71	100	46,5		
D	d	L	A	H																														
G 1/4"	Ø 10	44	83	35,3																														
G 3/8"	Ø 11	46	83	36																														
1/2"	Ø 14	50	83	37																														
3/4"	Ø 19	58	83	40,5																														
G 1"	Ø 24	71	100	46,5																														

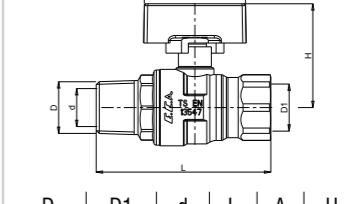
ENDÜSTRİYEL TİP KÜRESEL VALFLER-PN25

ÜRÜN	ÜRÜN KODU	ÜRÜN ADI	TEKNİK ÇİZİM	LİSTE FİYATI ₺	ÜRÜN KT. AD.																																									
	602 122 237	1/2" ENDÜSTRİYEL TİP KÜRESEL VALF İÇ VE DIŞ VIDA - TAM GEÇİŞLİ		64	24																																									
	602 122 238	3/4" ENDÜSTRİYEL TİP KÜRESEL VALF İÇ VE DIŞ VIDA - TAM GEÇİŞLİ		79	12																																									
	602 122 239	1" ENDÜSTRİYEL TİP KÜRESEL VALF İÇ VE DIŞ VIDA - TAM GEÇİŞLİ		120	15																																									
	602 122 240	1 1/4" ENDÜSTRİYEL TİP KÜRESEL VALF İÇ VE DIŞ VIDA - TAM GEÇİŞLİ		260	8																																									
	602 122 241	1 1/2" ENDÜSTRİYEL TİP KÜRESEL VALF İÇ VE DIŞ VIDA - TAM GEÇİŞLİ		338	6																																									
	602 122 242	2" ENDÜSTRİYEL TİP KÜRESEL VALF İÇ VE DIŞ VIDA - TAM GEÇİŞLİ		601	3																																									
		• TS CEN TS 13547 • Çalışma sıcaklık Aralığı: -30°C +80°C																																												
		<table border="1"> <thead> <tr> <th>D</th> <th>D1</th> <th>d</th> <th>L</th> <th>A</th> <th>H</th> </tr> </thead> <tbody> <tr> <td>R 1/2"</td> <td>Rp 1/2"</td> <td>Ø 10</td> <td>44</td> <td>83</td> <td>35,3</td> </tr> <tr> <td>R 3/4"</td> <td>Rp 3/4"</td> <td>Ø 11</td> <td>46</td> <td>83</td> <td>36</td> </tr> <tr> <td>R 1"</td> <td>Rp 1"</td> <td>Ø 14</td> <td>50</td> <td>83</td> <td>37</td> </tr> <tr> <td>R 1 1/4"</td> <td>Rp 1 1/4"</td> <td>Ø 19</td> <td>58</td> <td>83</td> <td>40,5</td> </tr> <tr> <td>R 1 1/2"</td> <td>Rp 1 1/2"</td> <td>Ø 24</td> <td>71</td> <td>100</td> <td>46,5</td> </tr> <tr> <td>R 2"</td> <td>Rp 2"</td> <td>Ø 24</td> <td>71</td> <td>100</td> <td>46,5</td> </tr> </tbody> </table>		D	D1	d	L	A	H	R 1/2"	Rp 1/2"	Ø 10	44	83	35,3	R 3/4"	Rp 3/4"	Ø 11	46	83	36	R 1"	Rp 1"	Ø 14	50	83	37	R 1 1/4"	Rp 1 1/4"	Ø 19	58	83	40,5	R 1 1/2"	Rp 1 1/2"	Ø 24	71	100	46,5	R 2"	Rp 2"	Ø 24	71	100	46,5	
D	D1	d	L	A	H																																									
R 1/2"	Rp 1/2"	Ø 10	44	83	35,3																																									
R 3/4"	Rp 3/4"	Ø 11	46	83	36																																									
R 1"	Rp 1"	Ø 14	50	83	37																																									
R 1 1/4"	Rp 1 1/4"	Ø 19	58	83	40,5																																									
R 1 1/2"	Rp 1 1/2"	Ø 24	71	100	46,5																																									
R 2"	Rp 2"	Ø 24	71	100	46,5																																									

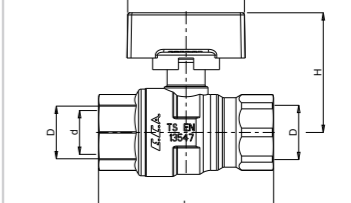
ENDÜSTRİYEL TİP KÜRESEL VALFLER - PN25

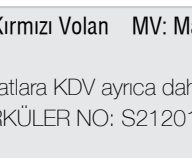

ÜRÜN	ÜRÜN KODU	ÜRÜN ADI	TEKNİK ÇİZİM	LİSTE FİYATI ₺	ÜRÜN KT. AD.																			
	KV: 602 122 243 MV: 602 122 244	1/2" ENDÜSTRİYEL TİP KÜRESEL VALF İÇ VE DIŞ VIDA - TAM GEÇİŞLİ *		64	24																			
	KV: 602 122 245 MV: 602 122 246	3/4" ENDÜSTRİYEL TİP KÜRESEL VALF İÇ VE DIŞ VIDA - TAM GEÇİŞLİ		79	12																			
	KV: 602 122 247 MV: 602 122 248	1" ENDÜSTRİYEL TİP KÜRESEL VALF İÇ VE DIŞ VIDA - TAM GEÇİŞLİ		120	15																			
		• TS CEN TS 13547 • Çalışma sıcaklık Aralığı: -30°C +80°C • 1/2"-3/4" özel plastik, 1" alüminyum volanlıdır.																						
	KV: 602 122 249 MV: 602 122 250	1/2" ENDÜSTRİYEL TİP KÜRESEL VALF KELEBEK VOLANLI İÇ VE İÇ VIDA - TAM GEÇİŞLİ*		62	24																			
	KV: 602 122 251 MV: 602 122 252	3/4" ENDÜSTRİYEL TİP KÜRESEL VALF KELEBEK VOLANLI İÇ VE İÇ VIDA - TAM GEÇİŞLİ		75	12																			
	KV: 602 122 253 MV: 602 122 254	1" ENDÜSTRİYEL TİP KÜRESEL VALF KELEBEK VOLANLI İÇ VE İÇ VIDA - TAM GEÇİŞLİ		117	15																			
		• TS CEN TS 13547 • Çalışma sıcaklık Aralığı: -30°C +80°C • 1/2"-3/4" özel plastik, 1" alüminyum volanlıdır.																						
		<table border="1"> <thead> <tr> <th>D</th> <th>d</th> <th>L</th> <th>A</th> <th>H</th> </tr> </thead> <tbody> <tr> <td>Rp 1/2"</td> <td>Ø 15</td> <td>60</td> <td>40</td> <td>41</td> </tr> <tr> <td>Rp 3/4"</td> <td>Ø 20</td> <td>68,5</td> <td>60</td> <td>48,7</td> </tr> <tr> <td>Rp 1"</td> <td>Ø 25</td> <td>83</td> <td>60</td> <td>53</td> </tr> </tbody> </table>	D	d	L	A	H	Rp 1/2"	Ø 15	60	40	41	Rp 3/4"	Ø 20	68,5	60	48,7	Rp 1"	Ø 25	83	60	53		
D	d	L	A	H																				
Rp 1/2"	Ø 15	60	40	41																				
Rp 3/4"	Ø 20	68,5	60	48,7																				
Rp 1"	Ø 25	83	60	53																				

KV: Kırmızı Volan MV: Mavi Volan



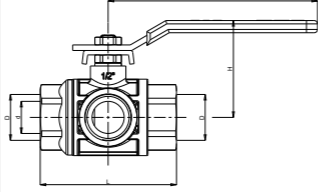

* G 1/2" ölçülü ürünler plastik volanlıdır.

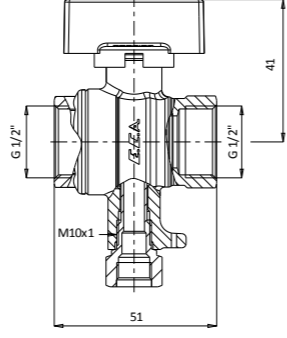
• Fiyatlara KDV ayrıca dahil edilir. Tavsiye edilen bayi satış fiyatıdır.
SİRKÜLER NO: S2120101



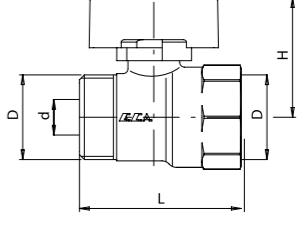

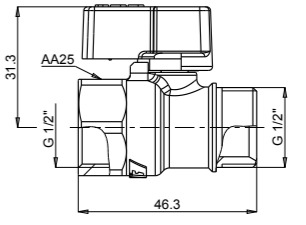
ÖZEL AMAÇLI KÜRESEL VALFLER (SU, YAĞ VE YANICI OLMAYAN GAZLAR İÇİN)

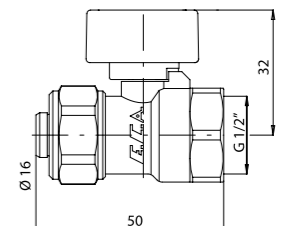
ÜRÜN	ÜRÜN KODU	ÜRÜN ADI	TEKNİK ÇİZİM	LİSTE FİYATI ₺	ÜRÜN KT. AD.																														
	102 122 131	1/4" ÜÇ YOLLU KÜRESEL VALF	 <table border="1"> <thead> <tr> <th>D</th> <th>d</th> <th>L</th> <th>A</th> <th>H</th> </tr> </thead> <tbody> <tr> <td>G 1/4"</td> <td>10</td> <td>50</td> <td>95</td> <td>41,3</td> </tr> <tr> <td>G 3/8"</td> <td>11</td> <td>52</td> <td>95</td> <td>42,2</td> </tr> <tr> <td>1/2"</td> <td>14,5</td> <td>62</td> <td>95</td> <td>44,1</td> </tr> <tr> <td>3/4"</td> <td>19</td> <td>71</td> <td>115</td> <td>52,7</td> </tr> <tr> <td>G 1"</td> <td>24</td> <td>83</td> <td>115</td> <td>56,7</td> </tr> </tbody> </table>	D	d	L	A	H	G 1/4"	10	50	95	41,3	G 3/8"	11	52	95	42,2	1/2"	14,5	62	95	44,1	3/4"	19	71	115	52,7	G 1"	24	83	115	56,7	121	24
	D	d		L	A	H																													
	G 1/4"	10		50	95	41,3																													
	G 3/8"	11		52	95	42,2																													
	1/2"	14,5		62	95	44,1																													
3/4"	19	71	115	52,7																															
G 1"	24	83	115	56,7																															
102 122 132	3/8" ÜÇ YOLLU KÜRESEL VALF	137	24																																
102 122 133	1/2" ÜÇ YOLLU KÜRESEL VALF	191	20																																
102 122 134	3/4" ÜÇ YOLLU KÜRESEL VALF	260	10																																
102 122 135	1" ÜÇ YOLLU KÜRESEL VALF	390	15																																
	602 122 149	1/2" TERMOKUPL ÇIKIŞLI KÜRESEL VALF		81	24																														
		<ul style="list-style-type: none"> Termokupl tipi hissedici kovanı bulunur. Çalışma sıcaklık Aralığı: -30°C +80°C 																																	

MİNİ KÜRESEL VALFLER (SU, YAĞ VE YANICI OLMAYAN GAZLAR İÇİN)

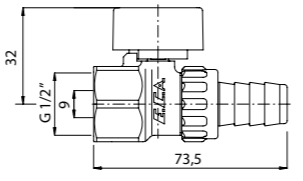
ÜRÜN	ÜRÜN KODU	ÜRÜN ADI	TEKNİK ÇİZİM	LİSTE FİYATI ₺	ÜRÜN KT. AD.																								
	102 122 027	3/8" KÜRESEL VALF, KIRMIZI VOLAN İÇİDİŞ VİDA	 <table border="1"> <thead> <tr> <th>D₁</th> <th>D₂</th> <th>d(Ø)</th> <th>L</th> <th>H</th> <th>AA/SW</th> </tr> </thead> <tbody> <tr> <td>G 3/8"</td> <td></td> <td>8</td> <td>40</td> <td>30</td> <td>22</td> </tr> <tr> <td>1/2"</td> <td></td> <td>10</td> <td>44</td> <td>32</td> <td>25</td> </tr> <tr> <td>3/4"</td> <td></td> <td>11</td> <td>50</td> <td>38</td> <td>31</td> </tr> </tbody> </table>	D ₁	D ₂	d(Ø)	L	H	AA/SW	G 3/8"		8	40	30	22	1/2"		10	44	32	25	3/4"		11	50	38	31	46	30
	D ₁	D ₂		d(Ø)	L	H	AA/SW																						
	G 3/8"			8	40	30	22																						
1/2"		10	44	32	25																								
3/4"		11	50	38	31																								
102 122 028	1/2" KÜRESEL VALF, KIRMIZI VOLAN İÇİDİŞ VİDA	52	30																										
102 122 029	3/4" KÜRESEL VALF, KIRMIZI VOLAN İÇİDİŞ VİDA	70	15																										
	602 122 003	1/2" MİNİ KÜRESEL VALF MAVİ VOLANLI İÇİDİŞ VİDA		52	30																								
		<ul style="list-style-type: none"> TSEK PN10 Çalışma Sıcaklık Aralığı: -30°C +80°C Özel Plastik L volan 																											
 	kırmızı volanlı: 102 122 031	1/2" RAKORLU MİNİ KÜRESEL VALF KENDİNDEN HORTUM UÇLU Ø 16X2 mm PEX		60	24																								
	mavi volanlı: 102 122 348	<ul style="list-style-type: none"> TSEK PN10 Çalışma Sıcaklık Aralığı: -30°C +80°C Özel Plastik T(kelebek) volan 		60	24																								

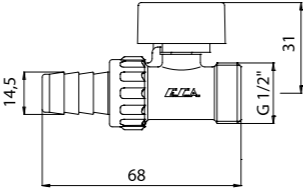
HORTUM UÇLU MİNİ KÜRESEL VALFLER (SU, YAĞ VE YANICI OLMAYAN GAZLAR İÇİN)

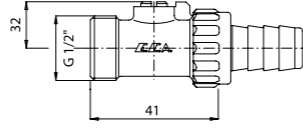
ÜRÜN	ÜRÜN KODU	ÜRÜN ADI	TEKNİK ÇİZİM	LİSTE FİYATI ₺	ÜRÜN KT. AD.
	kırmızı volanlı: 602 122 001* mavi volanlı: 602 122 009*	1/2" BOŞALTIMA MUSLUĞU • TSEK • PN10 • Çalışma Sıcaklık Aralığı: -30°C +80°C • Özel Plastik T(kelebek) volan		69 69	24 24
	kırmızı volanlı: 102 122 380 mavi volanlı: 102 122 379	1/2" BOŞALTIMA MUSLUĞU O - RİNGLİ • TSEK • PN10 • Çalışma Sıcaklık Aralığı: -30°C +80°C • Özel Plastik L volan • O-Ring sızdırmazlık halkalı		65 65	24 24
	602 122 004*	1/2" TORNAVİDA MİLLİ BOŞALTIMA MUSLUĞU • TSEK • PN10 • Çalışma Sıcaklık Aralığı: -30C +80C • O-Ring sızdırmazlık halkalı		62	24

* İlgili ürünler sipariş bazında özel üretilir.

• Standart belgelerine ve belgelendirme kapsamındaki ürünlere www.eca.com.tr, www.valf.com.tr üzerinden ulaşılabilir.
• Katalogda yer alan resimler bilgi içindir. Elmor Tesisat Malzemeleri Tic. A.Ş. mamul fiyat ve görünüş detaylarında değişiklik yapma hakkına sahiptir.

ŞİBER VALFLER

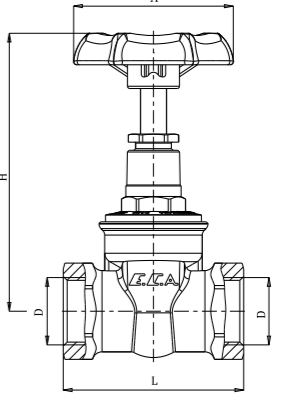
ÜRÜN	ÜRÜN KODU	ÜRÜN ADI	TEKNİK ÇİZİM	LİSTE FİYATI ₺	ÜRÜN KT. AD.																										
	601 003 019	1/2" ŞİBER VALF		88	30																										
	601 003 020	3/4" ŞİBER VALF		104	20																										
	601 003 021	1" ŞİBER VALF		177	20																										
	601 003 022	1 1/4" ŞİBER VALF		293	12																										
	601 003 023	1 1/2" ŞİBER VALF		343	12																										
	601 003 024	2" ŞİBER VALF		523	8																										
		• TS EN 12288 • Özel plastik çevirme volanı • PN 25 • Max. çalışma sıcaklığı: 90°C		<table border="1"> <thead> <tr> <th>D</th> <th>L</th> <th>H</th> <th>A</th> </tr> </thead> <tbody> <tr> <td>1/2"</td> <td>55,5</td> <td>85</td> <td>49</td> </tr> <tr> <td>3/4"</td> <td>58</td> <td>96</td> <td>59</td> </tr> <tr> <td>G 1"</td> <td>68</td> <td>103</td> <td>59</td> </tr> <tr> <td>G 1 1/4"</td> <td>78</td> <td>109</td> <td>68,5</td> </tr> <tr> <td>G 1 1/2"</td> <td>80,5</td> <td>119</td> <td>68,5</td> </tr> <tr> <td>G 2"</td> <td>93</td> <td>148</td> <td>83</td> </tr> </tbody> </table>	D	L	H	A	1/2"	55,5	85	49	3/4"	58	96	59	G 1"	68	103	59	G 1 1/4"	78	109	68,5	G 1 1/2"	80,5	119	68,5	G 2"	93	148
D	L	H	A																												
1/2"	55,5	85	49																												
3/4"	58	96	59																												
G 1"	68	103	59																												
G 1 1/4"	78	109	68,5																												
G 1 1/2"	80,5	119	68,5																												
G 2"	93	148	83																												

ŞİBER VALFLER, OPTİMİZE TİP

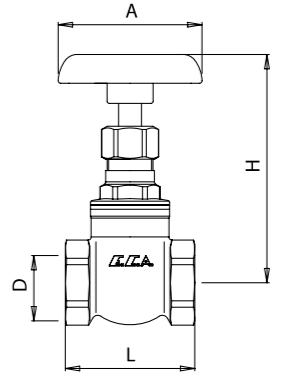
ÜRÜN	ÜRÜN KODU	ÜRÜN ADI	TEKNİK ÇİZİM	LİSTE FİYATI ₺	ÜRÜN KT. AD.																																							
	601 003 001	1/2" ŞİBER VALF		82	30																																							
	601 003 002	3/4" ŞİBER VALF		94	20																																							
	601 003 003	1" ŞİBER VALF		163	20																																							
	601 003 004	1 1/4" ŞİBER VALF		281	12																																							
	601 003 005	1 1/2" ŞİBER VALF		337	12																																							
	601 003 006	2" ŞİBER VALF		503	9																																							
	601 003 015	2 1/2" ŞİBER VALF		983	4																																							
	601 003 016	3" ŞİBER VALF		1.576	2																																							
	601 003 017	4" ŞİBER VALF		2.187	1																																							
		• Özel plastik çevirme volanı • PN 16 • Max. çalışma sıcaklığı: 90°C		<table border="1"> <thead> <tr> <th>D</th> <th>L</th> <th>H</th> <th>A</th> </tr> </thead> <tbody> <tr> <td>1/2"</td> <td>40</td> <td>89</td> <td>50</td> </tr> <tr> <td>3/4"</td> <td>49</td> <td>97</td> <td>60</td> </tr> <tr> <td>G 1"</td> <td>50</td> <td>106,5</td> <td>60</td> </tr> <tr> <td>G 1 1/4"</td> <td>58</td> <td>117</td> <td>70</td> </tr> <tr> <td>G 1 1/2"</td> <td>62</td> <td>129</td> <td>70</td> </tr> <tr> <td>G 2"</td> <td>68</td> <td>150</td> <td>80</td> </tr> <tr> <td>G 2 1/2"</td> <td>78</td> <td>180,5</td> <td>110</td> </tr> <tr> <td>G 3"</td> <td>90</td> <td>210</td> <td>110</td> </tr> <tr> <td>G 4"</td> <td>102</td> <td>221</td> <td>130</td> </tr> </tbody> </table>	D	L	H	A	1/2"	40	89	50	3/4"	49	97	60	G 1"	50	106,5	60	G 1 1/4"	58	117	70	G 1 1/2"	62	129	70	G 2"	68	150	80	G 2 1/2"	78	180,5	110	G 3"	90	210	110	G 4"	102	221	130
D	L	H		A																																								
1/2"	40	89		50																																								
3/4"	49	97		60																																								
G 1"	50	106,5		60																																								
G 1 1/4"	58	117		70																																								
G 1 1/2"	62	129	70																																									
G 2"	68	150	80																																									
G 2 1/2"	78	180,5	110																																									
G 3"	90	210	110																																									
G 4"	102	221	130																																									

• Fiyatlara KDV ayrıca dahil edilir. Tavsiye edilen bayi satış fiyatıdır.
SİRKÜLER NO: S2120101

STOP VALFLER

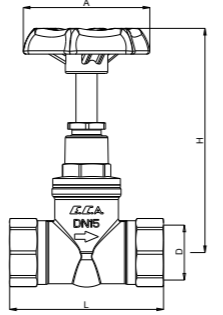
ÜRÜN	ÜRÜN KODU	ÜRÜN ADI	TEKNİK ÇİZİM	LİSTE FİYATI ₺	ÜRÜN KT. AD.																												
	601 005 031	1/2" STOP VALF	 <table border="1"> <thead> <tr> <th>D</th> <th>L</th> <th>A</th> <th>H</th> </tr> </thead> <tbody> <tr> <td>1/2"</td> <td>58</td> <td>49</td> <td>84</td> </tr> <tr> <td>3/4"</td> <td>63</td> <td>58</td> <td>94</td> </tr> <tr> <td>G 1"</td> <td>77</td> <td>58</td> <td>103</td> </tr> <tr> <td>G1 1/4"</td> <td>94</td> <td>68.4</td> <td>125</td> </tr> <tr> <td>G1 1/2"</td> <td>100</td> <td>82.7</td> <td>130.7</td> </tr> <tr> <td>G 2"</td> <td>120</td> <td>82.7</td> <td>148.7</td> </tr> </tbody> </table>	D	L	A	H	1/2"	58	49	84	3/4"	63	58	94	G 1"	77	58	103	G1 1/4"	94	68.4	125	G1 1/2"	100	82.7	130.7	G 2"	120	82.7	148.7	86	60
	D	L		A	H																												
	1/2"	58		49	84																												
	3/4"	63		58	94																												
	G 1"	77		58	103																												
	G1 1/4"	94		68.4	125																												
	G1 1/2"	100		82.7	130.7																												
G 2"	120	82.7	148.7																														
601 005 032	3/4" STOP VALF	117	35																														
601 005 033	1" STOP VALF	191	20																														
601 005 034	1 1/4" STOP VALF	299	10																														
601 005 035	1 1/2" STOP VALF	412	8																														
601 005 036	2" STOP VALF	718	6																														
		<ul style="list-style-type: none"> • TS 15 EN1213 • Özel plastik çevirme volanı • PN 10 • Max. çalışma sıcaklığı: 80°C 																															

FİLTRELER

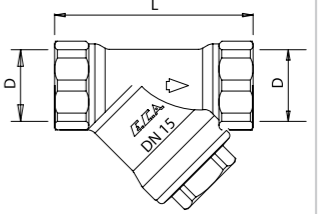
ÜRÜN	ÜRÜN KODU	ÜRÜN ADI	TEKNİK ÇİZİM	LİSTE FİYATI ₺	ÜRÜN KT. AD.														
	601 010 001	1/2" FİLTRE	 <table border="1"> <thead> <tr> <th>D</th> <th>L</th> </tr> </thead> <tbody> <tr> <td>G 1/2"</td> <td>57</td> </tr> <tr> <td>G 3/4"</td> <td>69</td> </tr> <tr> <td>G 1"</td> <td>86.7</td> </tr> <tr> <td>G 1 1/4"</td> <td>92</td> </tr> <tr> <td>G 1 1/2"</td> <td>102</td> </tr> <tr> <td>G 2"</td> <td>122</td> </tr> </tbody> </table>	D	L	G 1/2"	57	G 3/4"	69	G 1"	86.7	G 1 1/4"	92	G 1 1/2"	102	G 2"	122	65	40
	D	L																	
	G 1/2"	57																	
	G 3/4"	69																	
	G 1"	86.7																	
	G 1 1/4"	92																	
	G 1 1/2"	102																	
G 2"	122																		
601 010 002	3/4" FİLTRE	79	25																
601 010 003	1" FİLTRE	117	14																
601 010 004	1 1/4" FİLTRE	189	8																
601 010 005	1 1/2" FİLTRE	247	5																
601 010 006	2" FİLTRE	434	3																
		<ul style="list-style-type: none"> • TSEK • Çalışma basıncı : 25 bar • Max. çalışma sıcaklığı : -30°C, +80°C • Özel paslanmaz çelik filtre (140 delik/cm2) 																	

KOSVA VALFLER

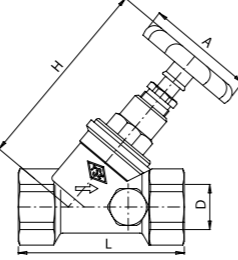
ÜRÜN	ÜRÜN KODU	ÜRÜN ADI	TEKNİK ÇİZİM	LİSTE FİYATI ₺	ÜRÜN KT. AD.																												
	601 004 001	1/2" KOSVA VALF	 <table border="1"> <thead> <tr> <th>D</th> <th>L</th> <th>H</th> <th>A</th> </tr> </thead> <tbody> <tr> <td>1/2"</td> <td>57</td> <td>50</td> <td>84,5</td> </tr> <tr> <td>3/4"</td> <td>67</td> <td>60</td> <td>100</td> </tr> <tr> <td>G 1"</td> <td>78</td> <td>60</td> <td>118</td> </tr> <tr> <td>G 1 1/4"</td> <td>92</td> <td>70</td> <td>137</td> </tr> <tr> <td>G 1 1/2"</td> <td>102</td> <td>80</td> <td>152</td> </tr> <tr> <td>G 2"</td> <td>122</td> <td>90</td> <td>177</td> </tr> </tbody> </table>	D	L	H	A	1/2"	57	50	84,5	3/4"	67	60	100	G 1"	78	60	118	G 1 1/4"	92	70	137	G 1 1/2"	102	80	152	G 2"	122	90	177	126	40
	D	L		H	A																												
	1/2"	57		50	84,5																												
	3/4"	67		60	100																												
	G 1"	78		60	118																												
	G 1 1/4"	92		70	137																												
G 1 1/2"	102	80	152																														
G 2"	122	90	177																														
601 004 002	3/4" KOSVA VALF	163	25																														
601 004 003	1" KOSVA VALF	237	15																														
601 004 004	1 1/4" KOSVA VALF	434	12																														
601 004 005	1 1/2" KOSVA VALF	508	8																														
601 004 006	2" KOSVA VALF	789	5																														
		<ul style="list-style-type: none"> • Özel plastik çevirme volanı • Akış çıkış yönünde, sağ ve sol yana takılabilen özel plastik akuple boşaltma vanalı • PN 10 • Max. çalışma sıcaklığı: 80°C 																															

ÇALPARA ÇEKVALF

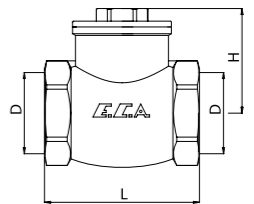
ÜRÜN	ÜRÜN KODU	ÜRÜN ADI	TEKNİK ÇİZİM	LİSTE FİYATI ₺	ÜRÜN KT. AD.												
	101 007 092	1/2" ÇALPARA ÇEKVALF	 <table border="1"> <thead> <tr> <th>D</th> <th>L</th> <th>H</th> </tr> </thead> <tbody> <tr> <td>G 1/2"</td> <td>46,5</td> <td>31,5</td> </tr> <tr> <td>G 3/4"</td> <td>56,5</td> <td>34,5</td> </tr> <tr> <td>G 1"</td> <td>63</td> <td>39</td> </tr> </tbody> </table>	D	L	H	G 1/2"	46,5	31,5	G 3/4"	56,5	34,5	G 1"	63	39	74	40
	D	L		H													
	G 1/2"	46,5		31,5													
G 3/4"	56,5	34,5															
G 1"	63	39															
101 007 093	3/4" ÇALPARA ÇEKVALF	88	20														
101 007 094	1" ÇALPARA ÇEKVALF	122	14														
		<ul style="list-style-type: none"> • TS EN 1074-3 • Özel askı tasarımı ile sarkaç tipi çalışan, kauçuk contalı klape grubu • Çalışma basıncı : 25 bar • Maksimum çalışma sıcaklığı : +80°C 															

YATAY ÇEKVALF

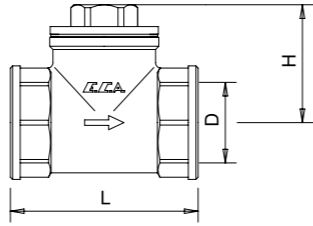
ÜRÜN	ÜRÜN KODU	ÜRÜN ADI	TEKNİK ÇİZİM	LİSTE FİYATI ₺	ÜRÜN KT. AD.																					
	601 007 022	1/2" ÇEKVALF	 <table border="1"> <thead> <tr> <th>D</th> <th>L</th> <th>H</th> </tr> </thead> <tbody> <tr> <td>G 1/2"</td> <td>55</td> <td>32</td> </tr> <tr> <td>G 3/4"</td> <td>65</td> <td>36,5</td> </tr> <tr> <td>G 1"</td> <td>75</td> <td>39,3</td> </tr> <tr> <td>G 1 1/4"</td> <td>88</td> <td>49,8</td> </tr> <tr> <td>G 1 1/2"</td> <td>98</td> <td>56,3</td> </tr> <tr> <td>G 2"</td> <td>116</td> <td>66</td> </tr> </tbody> </table>	D	L	H	G 1/2"	55	32	G 3/4"	65	36,5	G 1"	75	39,3	G 1 1/4"	88	49,8	G 1 1/2"	98	56,3	G 2"	116	66	99	35
D	L	H																								
G 1/2"	55	32																								
G 3/4"	65	36,5																								
G 1"	75	39,3																								
G 1 1/4"	88	49,8																								
G 1 1/2"	98	56,3																								
G 2"	116	66																								
	601 007 023	3/4" ÇEKVALF	137	14																						
	601 007 024	1" ÇEKVALF	200	14																						
	601 007 025	1 1/4" ÇEKVALF	363	6																						
	601 007 026	1 1/2" ÇEKVALF	482	10																						
	601 007 027	2" ÇEKVALF	718	5																						
		<ul style="list-style-type: none"> • TS EN 1074-3 • Klape tasarımından dolayı yatay monte edilmelidir. • Çalışma basıncı : 25 bar • Maksimum çalışma sıcaklığı : +80°C 																								

KUYU ÇEKVALF

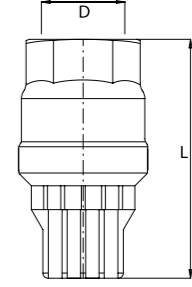
ÜRÜN	ÜRÜN KODU	ÜRÜN ADI	TEKNİK ÇİZİM	LİSTE FİYATI ₺	ÜRÜN KT. AD.												
	601 007 017	3/4" KUYU ÇEKVALF	 <table border="1"> <thead> <tr> <th>D</th> <th>L</th> </tr> </thead> <tbody> <tr> <td>G 3/4"</td> <td>80</td> </tr> <tr> <td>G 1"</td> <td>93</td> </tr> <tr> <td>G 1 1/4"</td> <td>100</td> </tr> <tr> <td>G 1 1/2"</td> <td>110</td> </tr> <tr> <td>G 2"</td> <td>120</td> </tr> </tbody> </table>	D	L	G 3/4"	80	G 1"	93	G 1 1/4"	100	G 1 1/2"	110	G 2"	120	75	20
D	L																
G 3/4"	80																
G 1"	93																
G 1 1/4"	100																
G 1 1/2"	110																
G 2"	120																
	601 007 018	1" KUYU ÇEKVALF	88	15													
	601 007 019	1 1/4" KUYU ÇEKVALF	139	15													
	601 007 020	1 1/2" KUYU ÇEKVALF	195	8													
	601 007 021	2" KUYU ÇEKVALF	304	6													
		<ul style="list-style-type: none"> • TS EN 1074-3 • Özel tasarımlı, yay mekanizmalı klape grubu • Giriş tarafı plastik süzgeçli • Çalışma basıncı : 25 bar • Maksimum çalışma sıcaklığı : +80°C 															

YAYLI ÇEKVALF

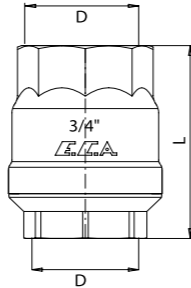
ÜRÜN	ÜRÜN KODU	ÜRÜN ADI	TEKNİK ÇİZİM	LİSTE FİYATI ₺	ÜRÜN KT. AD.														
	601 007 007	1/2" YAYLI ÇEKVALF	 <table border="1"> <thead> <tr> <th>D</th> <th>L</th> </tr> </thead> <tbody> <tr> <td>G 1/2"</td> <td>40</td> </tr> <tr> <td>G 3/4"</td> <td>50</td> </tr> <tr> <td>G 1"</td> <td>62,5</td> </tr> <tr> <td>G 1 1/4"</td> <td>67</td> </tr> <tr> <td>G 1 1/2"</td> <td>77</td> </tr> <tr> <td>G 2"</td> <td>85</td> </tr> </tbody> </table>	D	L	G 1/2"	40	G 3/4"	50	G 1"	62,5	G 1 1/4"	67	G 1 1/2"	77	G 2"	85	53	40
D	L																		
G 1/2"	40																		
G 3/4"	50																		
G 1"	62,5																		
G 1 1/4"	67																		
G 1 1/2"	77																		
G 2"	85																		
	601 007 008	3/4" YAYLI ÇEKVALF	62	15															
	601 007 009	1" YAYLI ÇEKVALF	88	10															
	601 007 010	1 1/4" YAYLI ÇEKVALF	126	6															
	601 007 011	1 1/2" YAYLI ÇEKVALF	229	4															
	601 007 012	2" YAYLI ÇEKVALF	332	3															
		<ul style="list-style-type: none"> • TS EN 1074-3 • Özel tasarımlı, yay mekanizmalı klape grubu • Çalışma basıncı: 25 bar • Maksimum çalışma sıcaklığı : +80°C 																	

FLATÖRLER

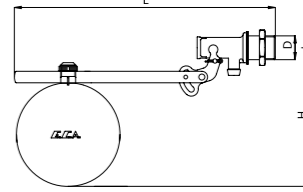
ÜRÜN	ÜRÜN KODU	ÜRÜN ADI	TEKNİK ÇİZİM	LİSTE FİYATI ₺	ÜRÜN KT. AD.																								
	101 009 001	3/8" FLATÖR	 <table border="1"> <thead> <tr> <th>D</th> <th>L</th> <th>H</th> </tr> </thead> <tbody> <tr> <td>G 3/8"</td> <td>348</td> <td>95</td> </tr> <tr> <td>1/2"</td> <td>335</td> <td>95</td> </tr> <tr> <td>3/4"</td> <td>375</td> <td>107,3</td> </tr> <tr> <td>G 1"</td> <td>375</td> <td>107,3</td> </tr> <tr> <td>G 1 1/4"</td> <td>415</td> <td>96,2</td> </tr> <tr> <td>G 1 1/2"</td> <td>415</td> <td>96,2</td> </tr> <tr> <td>G 2"</td> <td>415</td> <td>96,2</td> </tr> </tbody> </table>	D	L	H	G 3/8"	348	95	1/2"	335	95	3/4"	375	107,3	G 1"	375	107,3	G 1 1/4"	415	96,2	G 1 1/2"	415	96,2	G 2"	415	96,2	139	20
D	L	H																											
G 3/8"	348	95																											
1/2"	335	95																											
3/4"	375	107,3																											
G 1"	375	107,3																											
G 1 1/4"	415	96,2																											
G 1 1/2"	415	96,2																											
G 2"	415	96,2																											
	101 009 002	1/2" FLATÖR	146	20																									
	101 009 003	3/4" FLATÖR	183	10																									
	101 009 004	1" FLATÖR	211	10																									
	101 009 005	1 1/4" FLATÖR	452	4																									
	101 009 006	1 1/2" FLATÖR	486	4																									
	101 009 007	2" FLATÖR	594	4																									
		<ul style="list-style-type: none"> • TSEK • Çalışma basıncı : 6 bar • Maksimum çalışma sıcaklığı : +80°C • Çalışma basıncının üzerinden kullanımlarda mutlaka basınç düşürücü kullanınız. 																											

TESİSATINIZI VE CİHAZLARINIZI
YÜKSEK SU BASINCININ
OLUMSUZ ETKİLERİNDEN
KORUYUN.

TASARRUF

+80°C

PN16













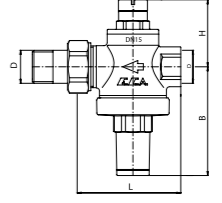

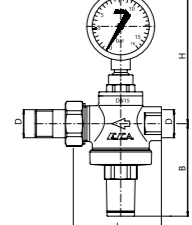
KONFOR

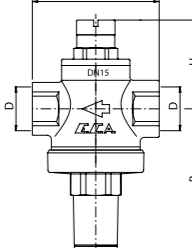
EMNİYET

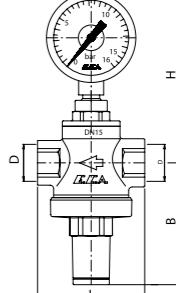

ÇIKIŞ
1-5 bar

GİRİŞ
16 bar

SU BASINÇ DÜŞÜRÜCÜ VALFLER

ÜRÜN	ÜRÜN KODU	ÜRÜN ADI	TEKNİK ÇİZİM	LİSTE FİYATI ₺	ÜRÜN KT. AD.																				
	602 111 007	1/2" BASINÇ DÜŞÜRÜCÜ VALF PİSTONLU, İÇ VİDA X RAKORLU	 <table border="1"> <thead> <tr> <th>D</th> <th>L</th> <th>H</th> <th>A</th> </tr> </thead> <tbody> <tr> <td>1/2"</td> <td>60</td> <td>68</td> <td>42</td> </tr> <tr> <td>3/4"</td> <td>60</td> <td>68</td> <td>42</td> </tr> </tbody> </table>	D	L	H	A	1/2"	60	68	42	3/4"	60	68	42	269	10								
D	L	H		A																					
1/2"	60	68	42																						
3/4"	60	68	42																						
	102 199 160	3/4" BASINÇ DÜŞÜRÜCÜ VALF PİSTONLU, İÇ VİDA X RAKORLU	298	10																					
	602 111 006	1/2" MANOMETRELİ BASINÇ DÜŞÜRÜCÜ VALF PİSTONLU, İÇ VİDA X RAKORLU	 <table border="1"> <thead> <tr> <th>D</th> <th>L</th> <th>H</th> <th>A</th> </tr> </thead> <tbody> <tr> <td>1/2"</td> <td>65</td> <td>68</td> <td>95</td> </tr> <tr> <td>3/4"</td> <td>65,8</td> <td>68</td> <td>95</td> </tr> </tbody> </table>	D	L	H	A	1/2"	65	68	95	3/4"	65,8	68	95	368	6								
D	L	H		A																					
1/2"	65	68	95																						
3/4"	65,8	68	95																						
	602 111 008	3/4" MANOMETRELİ BASINÇ DÜŞÜRÜCÜ VALF PİSTONLU, İÇ VİDA X RAKORLU	397	6																					
	602 111 004	1/2" BASINÇ DÜŞÜRÜCÜ VALF PİSTONLU, İÇ VİDA X İÇ VİDA	 <table border="1"> <thead> <tr> <th>D</th> <th>L</th> <th>B</th> <th>H</th> </tr> </thead> <tbody> <tr> <td>1/2"</td> <td>60</td> <td>68</td> <td>48</td> </tr> <tr> <td>3/4"</td> <td>60</td> <td>68</td> <td>48</td> </tr> <tr> <td>G 1"</td> <td>81</td> <td>97,7</td> <td>59</td> </tr> <tr> <td>G 1 1/4"</td> <td>88</td> <td>97,7</td> <td>59</td> </tr> </tbody> </table>	D	L	B	H	1/2"	60	68	48	3/4"	60	68	48	G 1"	81	97,7	59	G 1 1/4"	88	97,7	59	247	10
D	L	B		H																					
1/2"	60	68		48																					
3/4"	60	68		48																					
G 1"	81	97,7	59																						
G 1 1/4"	88	97,7	59																						
	602 111 009	3/4" BASINÇ DÜŞÜRÜCÜ VALF PİSTONLU, İÇ VİDA X İÇ VİDA	276	10																					
	602 111 038	1" BASINÇ DÜŞÜRÜCÜ VALF PİSTONLU, İÇ VİDA X İÇ VİDA	465	8																					
	602 111 037	1 1/4" BASINÇ DÜŞÜRÜCÜ VALF PİSTONLU, İÇ VİDA X İÇ VİDA	494	4																					
	602 111 005	1/2" MANOMETRELİ BASINÇ DÜŞÜRÜCÜ VALF PİSTONLU, İÇ VİDA X İÇ VİDA	 <table border="1"> <thead> <tr> <th>D</th> <th>L</th> <th>B</th> <th>H</th> </tr> </thead> <tbody> <tr> <td>1/2"</td> <td>60</td> <td>68</td> <td>95</td> </tr> <tr> <td>3/4"</td> <td>60</td> <td>68</td> <td>95</td> </tr> <tr> <td>G 1"</td> <td>81</td> <td>97,7</td> <td>110,7</td> </tr> <tr> <td>G 1 1/4"</td> <td>88</td> <td>97,7</td> <td>110,7</td> </tr> </tbody> </table>	D	L	B	H	1/2"	60	68	95	3/4"	60	68	95	G 1"	81	97,7	110,7	G 1 1/4"	88	97,7	110,7	346	6
D	L	B		H																					
1/2"	60	68		95																					
3/4"	60	68		95																					
G 1"	81	97,7	110,7																						
G 1 1/4"	88	97,7	110,7																						
	602 111 010	3/4" MANOMETRELİ BASINÇ DÜŞÜRÜCÜ VALF PİSTONLU, İÇ VİDA X İÇ VİDA	374	6																					
	602 111 042	1" MANOMETRELİ BASINÇ DÜŞÜRÜCÜ VALF PİSTONLU, İÇ VİDA X İÇ VİDA	549	8																					
	602 111 041	1 1/4" MANOMETRELİ BASINÇ DÜŞÜRÜCÜ VALF PİSTONLU, İÇ VİDA X İÇ VİDA	577	4																					

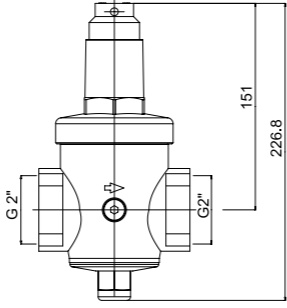
SU BASINÇ DÜŞÜRÜCÜ VALFLER

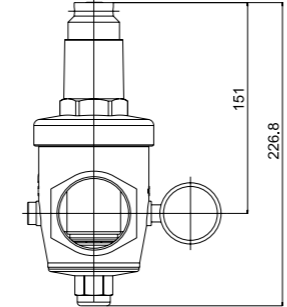

ÜRÜN	ÜRÜN KODU	ÜRÜN ADI	TEKNİK ÇİZİM	LİSTE FİYATI ₺	ÜRÜN KT. AD.
	602 111 018	2" BASINÇ DÜŞÜRÜCÜ VALF PİSTONLU, İÇ VIDA X İÇ VIDA		1.687	1
	602 111 019	2" MANOMETRELİ BASINÇ DÜŞÜRÜCÜ VALF PİSTONLU, İÇ VIDA X İÇ VIDA		1.769	1

Teknik Özellikler:

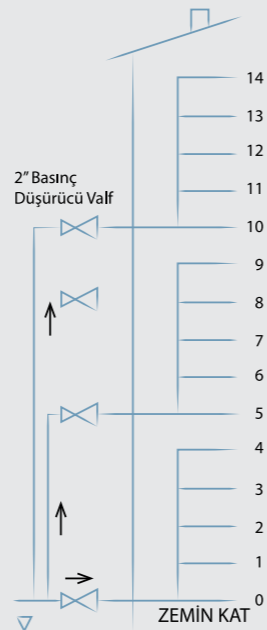
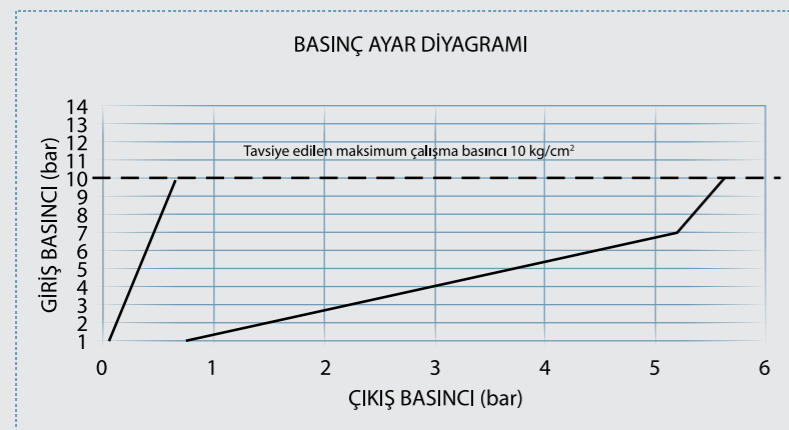

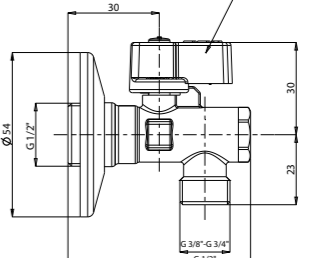

- TS EN 1567
- Paslanmaz çelik Piston klape
- Çalışma basıncı: 16 bar
- Çıkış Ayar basıncı: 1~5 bar
- Fabrika ayarı: 8 bar giriş - 3 bar çıkış
- Çıkış basıncında giriş basıncına ya da ihtiyaca göre Alyan yardımı ile farklı ayar imkanı.
- Maksimum çalışma sıcaklığı : +80°C

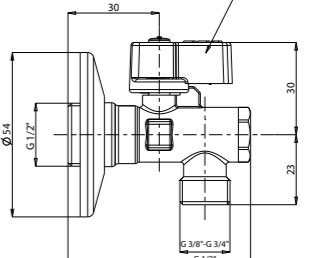



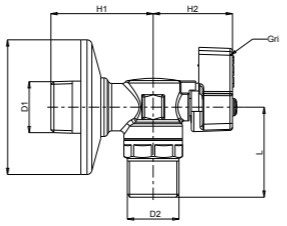

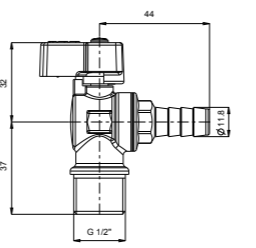
MUSLUKLAR

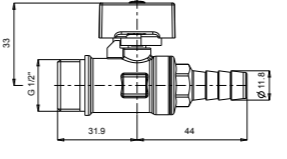
ÜRÜN	ÜRÜN KODU	ÜRÜN ADI	TEKNİK ÇİZİM	LİSTE FİYATI ₺	ÜRÜN KT. AD.
	102 122 041	1/2" ÇAMAŞIR - BULAŞIK MAKİNASI MUSLUĞU, ROZET DAHİL • TSEK • Polisajlı krom kaplama • Çalışma basıncı : 10 bar • Maksimum çalışma sıcaklığı : +80°C • Çıkış ucu 3/4"		111	25
	602 111 059	1/2" FİLTRELİ ÇAMAŞIR-BULAŞIK MAKİNASI MUSLUĞU (ROZET DAHİL) • TSEK • Nikel kaplama • Özel plastik L volan • Çalışma basıncı : 10 bar • Maksimum çalışma sıcaklığı : +80°C • Çıkış ucu 3/4"		53	30
	102 111 018	1/2" FİLTRELİ ARA MUSLUK, UZUN TİP (ROZET DAHİL) • TSEK • Polisajlı krom kaplama • Çalışma basıncı : 10 bar • Maksimum çalışma sıcaklığı : +80°C • Çıkış ucu 3/8"		104	30
	602 111 043	1/2" FİLTRELİ ARA MUSLUK, KISA TİP 3/8" ÇIKIŞ AĞIZLI (ROZET DAHİL)		48	30
	602 111 052	1/2" FİLTRELİ ARA MUSLUK, KISA TİP 1/2" ÇIKIŞ AĞIZLI (ROZET DAHİL)		48	30
	602 111 048	1/2" FİLTRELİ ARA MUSLUK, KISA TİP 3/8" ÇIKIŞ AĞIZLI KROM VOLAN - (ROZET DAHİL) • TSEK • Nikel kaplama • Özel plastik L volan • Çalışma basıncı : 10 bar • Maksimum çalışma sıcaklığı : +80°C • Çıkış ucu 3/8", 3/4", 1/2"		49	30
				64	30

MUSLUKLAR

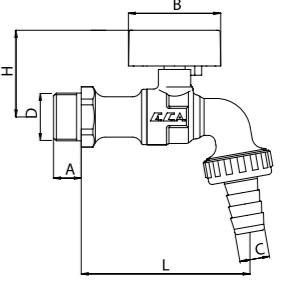
ÜRÜN	ÜRÜN KODU	ÜRÜN ADI	TEKNİK ÇİZİM	LİSTE FİYATI ₺	ÜRÜN KT. AD.																		
	602 111 066	ARA MUSLUK 1/2" X 1/2" KÖŞE		64	25																		
	602 111 067	ARA MUSLUK 1/2" X 3/4" KÖŞE, • Çalışma Basıncı: 10 bar • Maksimum Çalışma Sıcaklığı: +80°C • Çıkış Ucu 3/4", 1/2" • Rozet Dahil	<table border="1"> <thead> <tr> <th>D1</th> <th>D2</th> <th>H1</th> <th>H2</th> <th>L</th> <th>A</th> </tr> </thead> <tbody> <tr> <td>R 1/2"</td> <td>G 1/2"</td> <td>41</td> <td>32</td> <td>36</td> <td>Ø54</td> </tr> <tr> <td></td> <td>G 3/4"</td> <td></td> <td></td> <td>33</td> <td></td> </tr> </tbody> </table>	D1	D2	H1	H2	L	A	R 1/2"	G 1/2"	41	32	36	Ø54		G 3/4"			33		65	25
D1	D2	H1	H2	L	A																		
R 1/2"	G 1/2"	41	32	36	Ø54																		
	G 3/4"			33																			
	602 109 042	1/2" ARA MUSLUK, KÖŞE, HORTUM UÇLU		59	30																		
	602 109 043	1/2" ARA MUSLUK, DÜZ, HORTUM UÇLU • Çalışma Basıncı: 10 bar • Maksimum Çalışma Sıcaklığı: +80°C • Çıkış Ucu 3/8", 3/4", 1/2"		49	30																		

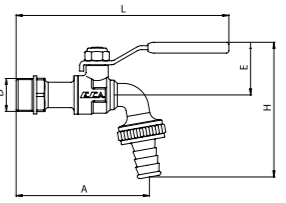
MUSLUKLAR

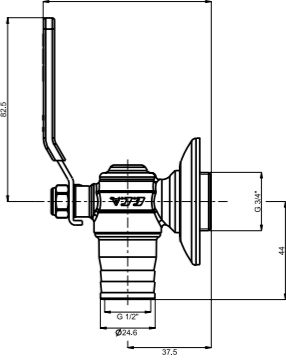
ÜRÜN	ÜRÜN KODU	ÜRÜN ADI	TEKNİK ÇİZİM	LİSTE FİYATI ₺	ÜRÜN KT. AD.															
	102 109 045	1/2" KÜRESEL BOŞALTMA MUSLUĞU	 <table border="1"> <thead> <tr> <th>D</th> <th>L</th> <th>H1</th> <th>H</th> <th>D1</th> </tr> </thead> <tbody> <tr> <td>1/2"</td> <td>73</td> <td>42</td> <td>12</td> <td>59</td> </tr> <tr> <td>3/4"</td> <td>77</td> <td>43</td> <td>12</td> <td>59</td> </tr> </tbody> </table>	D	L	H1	H	D1	1/2"	73	42	12	59	3/4"	77	43	12	59	94	24
D	L	H1		H	D1															
1/2"	73	42	12	59																
3/4"	77	43	12	59																
	102 109 046	3/4" KÜRESEL BOŞALTMA MUSLUĞU • TSEK • Nikel kaplama • Özel plastik T(kelebek) volan • Rakorlu hortum ucu • Çalışma basıncı : 10 bar • Maksimum çalışma sıcaklığı : +80°C		114	15															
	602 109 004	1/2" KÜRESEL BOŞALTMA MUSLUĞU	 <table border="1"> <thead> <tr> <th>D</th> <th>L</th> <th>A</th> <th>H</th> <th>E</th> </tr> </thead> <tbody> <tr> <td>1/2"</td> <td>135,5</td> <td>85</td> <td>85,3</td> <td>35,3</td> </tr> <tr> <td>3/4"</td> <td>140,4</td> <td>89</td> <td>88</td> <td>36</td> </tr> </tbody> </table>	D	L	A	H	E	1/2"	135,5	85	85,3	35,3	3/4"	140,4	89	88	36	87	30
D	L	A		H	E															
1/2"	135,5	85	85,3	35,3																
3/4"	140,4	89	88	36																
	602 109 005	3/4" KÜRESEL BOŞALTMA MUSLUĞU • TSEK • Nikel kaplama • 90° çevirme kolu • Rakorlu hortum ucu • Çalışma basıncı : 10 bar • Maksimum çalışma sıcaklığı : +80°C		107	30															
	102 109 120	3/4" KÜRESEL BAS, SABİT HORTUM UÇLU (MUSLUK ROZETİ DAHİL) • TSEK • Nikel kaplama • 90° çevirme kolu • Sabit hortum ucu • Çalışma basıncı : 10 bar • Maksimum çalışma sıcaklığı : +80°C		94	40															

DÖŞEMEDEN ISITMA ve DAĞITIM SİSTEMLERİ



Sihhi Tesisatlarda

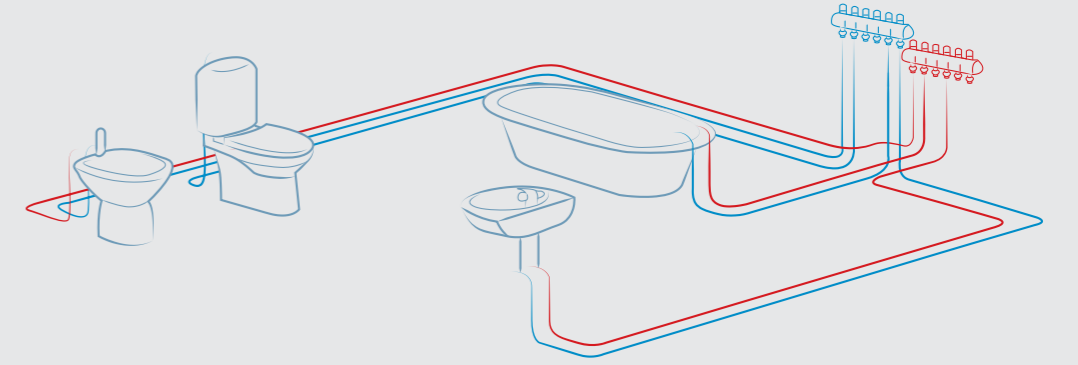

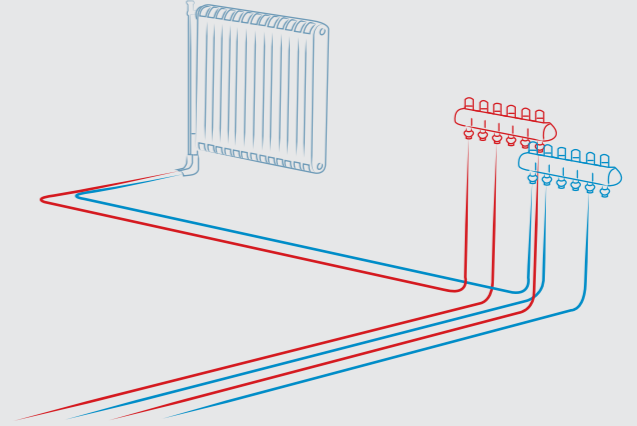

Radyatörlü Isıtma Sistemlerinde Kullanımı;

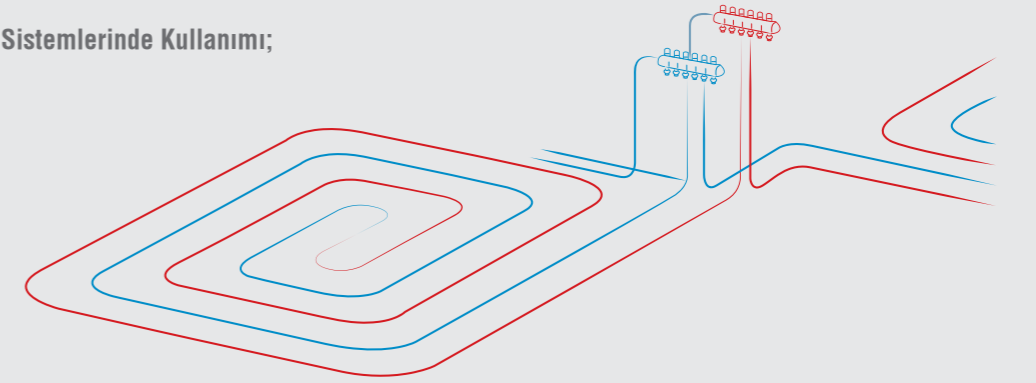

Döşemeden Isıtma Sistemlerinde Kullanımı;



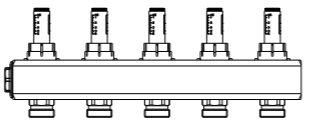
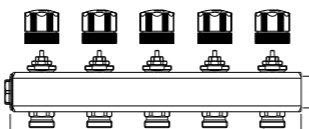

DÖŞEMEDEN ISITMA DEBİMETRELİ KOLEKTÖR SETİ

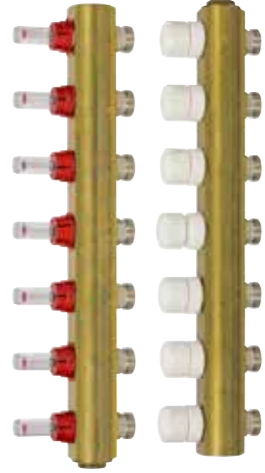
ÜRÜN	ÜRÜN KODU	ÜRÜN ADI	TEKNİK ÇİZİM	LİSTE FİYATI ₺	ÜRÜN KT. AD.																														
	601 026 097	DEBİMETRELİ KOLEKTÖR SET, 2'Lİ		554	12																														
	601 026 098	DEBİMETRELİ KOLEKTÖR SET, 3'LÜ		794	9																														
	601 026 099	DEBİMETRELİ KOLEKTÖR SET, 4'LÜ		1.034	6																														
	601 026 100	DEBİMETRELİ KOLEKTÖR SET, 5'Lİ		1.249	4																														
	601 026 101	DEBİMETRELİ KOLEKTÖR SET, 6'Lİ		1.490	4																														
	601 026 102	DEBİMETRELİ KOLEKTÖR SET, 7'Lİ		1.729	4																														
	601 026 103	DEBİMETRELİ KOLEKTÖR SET, 8'Lİ		1.946	3																														
	601 026 104	DEBİMETRELİ KOLEKTÖR SET, 9'LU		2.187	3																														
	601 026 105	DEBİMETRELİ KOLEKTÖR SET, 10'LU		2.404	3																														
	601 026 106	DEBİMETRELİ KOLEKTÖR SET, 11'Lİ		2.643	2																														
	601 026 107	DEBİMETRELİ KOLEKTÖR SET, 12'Lİ		2.883	2																														
	601 026 108	DEBİMETRELİ KOLEKTÖR SET, 13'LÜ	<table border="1"> <thead> <tr> <th>Çıkış Sayısı</th> <th>D</th> <th>d</th> <th>L</th> </tr> </thead> <tbody> <tr><td>2</td><td rowspan="13">G1"</td><td rowspan="13">3/4"</td><td>128,5</td></tr> <tr><td>3</td><td>188,5</td></tr> <tr><td>4</td><td>248,5</td></tr> <tr><td>5</td><td>308,5</td></tr> <tr><td>6</td><td>368,5</td></tr> <tr><td>7</td><td>428,5</td></tr> <tr><td>8</td><td>488,5</td></tr> <tr><td>9</td><td>548,5</td></tr> <tr><td>10</td><td>608,5</td></tr> <tr><td>11</td><td>668,5</td></tr> <tr><td>12</td><td>728,5</td></tr> <tr><td>13</td><td>788,5</td></tr> </tbody> </table>	Çıkış Sayısı	D	d	L	2	G1"	3/4"	128,5	3	188,5	4	248,5	5	308,5	6	368,5	7	428,5	8	488,5	9	548,5	10	608,5	11	668,5	12	728,5	13	788,5	3.099	2
Çıkış Sayısı	D	d	L																																
2	G1"	3/4"	128,5																																
3			188,5																																
4			248,5																																
5			308,5																																
6			368,5																																
7			428,5																																
8			488,5																																
9			548,5																																
10			608,5																																
11			668,5																																
12			728,5																																
13			788,5																																
				<ul style="list-style-type: none"> • Çalışma basıncı 6 bar • Test basıncı 10 bar (20°C) • Kullanma sıcaklığı -10°C - 70°C • Gidiş kolektörü debi ayar klapeli ve debi göstergelidir. • Dönüş kolektörü aktuatör montajına uygun hat ayar vanalıdır. • Kolektör tapaları dahildir. 																															



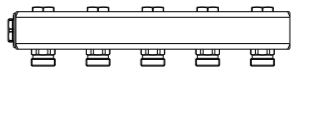
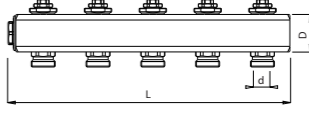



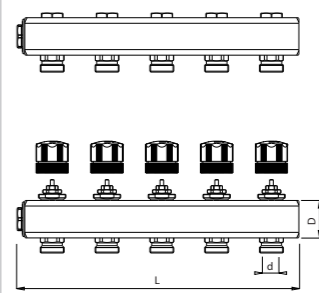

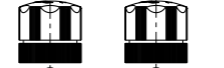

DÖŞEMEDEN ISITMA DEBİMETRESİZ KOLEKTÖR SETİ

ÜRÜN	ÜRÜN KODU	ÜRÜN ADI	TEKNİK ÇİZİM	LİSTE FİYATI ₺	ÜRÜN KT. AD.																														
	601 026 109	DEBİMETRESİZ KOLEKTÖR SET, 2'Lİ		456	12																														
	601 026 110	DEBİMETRESİZ KOLEKTÖR SET, 3'LÜ		650	9																														
	601 026 111	DEBİMETRESİZ KOLEKTÖR SET, 4'LÜ		818	6																														
	601 026 112	DEBİMETRESİZ KOLEKTÖR SET, 5'Lİ		1.010	4																														
	601 026 113	DEBİMETRESİZ KOLEKTÖR SET, 6'Lİ		1.201	4																														
	601 026 114	DEBİMETRESİZ KOLEKTÖR SET, 7'Lİ		1.370	4																														
	601 026 115	DEBİMETRESİZ KOLEKTÖR SET, 8'Lİ		1.561	3																														
	601 026 116	DEBİMETRESİZ KOLEKTÖR SET, 9'LU		1.729	3																														
	601 026 117	DEBİMETRESİZ KOLEKTÖR SET, 10'LU		1.923	3																														
	601 026 118	DEBİMETRESİZ KOLEKTÖR SET, 11'Lİ		2.090	2																														
	601 026 119	DEBİMETRESİZ KOLEKTÖR SET, 12'Lİ		2.283	2																														
	601 026 120	DEBİMETRESİZ KOLEKTÖR SET, 13'LÜ	<table border="1"> <thead> <tr> <th>Çıkış Sayısı</th> <th>D</th> <th>d</th> <th>L</th> </tr> </thead> <tbody> <tr><td>2</td><td rowspan="13">G1"</td><td rowspan="13">3/4"</td><td>128,5</td></tr> <tr><td>3</td><td>188,5</td></tr> <tr><td>4</td><td>248,5</td></tr> <tr><td>5</td><td>308,5</td></tr> <tr><td>6</td><td>368,5</td></tr> <tr><td>7</td><td>428,5</td></tr> <tr><td>8</td><td>488,5</td></tr> <tr><td>9</td><td>548,5</td></tr> <tr><td>10</td><td>608,5</td></tr> <tr><td>11</td><td>668,5</td></tr> <tr><td>12</td><td>728,5</td></tr> <tr><td>13</td><td>788,5</td></tr> </tbody> </table>	Çıkış Sayısı	D	d	L	2	G1"	3/4"	128,5	3	188,5	4	248,5	5	308,5	6	368,5	7	428,5	8	488,5	9	548,5	10	608,5	11	668,5	12	728,5	13	788,5	2.475	2
Çıkış Sayısı	D	d	L																																
2	G1"	3/4"	128,5																																
3			188,5																																
4			248,5																																
5			308,5																																
6			368,5																																
7			428,5																																
8			488,5																																
9			548,5																																
10			608,5																																
11			668,5																																
12			728,5																																
13			788,5																																
				<ul style="list-style-type: none"> • Çalışma Basıncı: 6 bar • Test Basıncı: 10 bar (20°C) • Kullanma sıcaklığı: -10°C , +70°C • Gidiş kolektöründe debi ayar klape grupları yoktur. • Dönüş kolektörü aktuatör montajına uygun hat ayar vanalıdır. • Kolektör tapaları dahildir. 																															

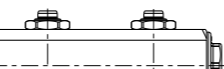
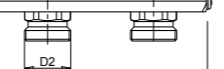

Çıkış Sayısı	D	d	L
2	G1"	3/4"	128,5
3			188,5
4			248,5
5			308,5
6			368,5
7			428,5
8			488,5
9			548,5
10			608,5
11			668,5
12			728,5
13			788,5

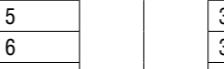
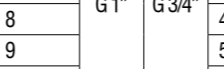
DÖŞEMEDEN ISITMA ALYAN ANAHTARLI KOLEKTÖR SETİ

ÜRÜN	ÜRÜN KODU	ÜRÜN ADI	TEKNİK ÇİZİM	LİSTE FİYATI ₺	ÜRÜN KT. AD.
	601 026 214	ALYAN ANAHTARLI KOLEKTÖR SETİ, 2'Lİ		498	12
	601 026 215	ALYAN ANAHTARLI KOLEKTÖR SETİ, 3'LÜ		715	9
	601 026 216	ALYAN ANAHTARLI KOLEKTÖR SETİ, 4'LÜ		931	6
	601 026 217	ALYAN ANAHTARLI KOLEKTÖR SETİ, 5'Lİ		1.125	4
	601 026 218	ALYAN ANAHTARLI KOLEKTÖR SETİ, 6'Lİ		1.340	4
	601 026 219	ALYAN ANAHTARLI KOLEKTÖR SETİ, 7'Lİ		1.556	4
	601 026 220	ALYAN ANAHTARLI KOLEKTÖR SETİ, 8'Lİ		1.751	3
	601 026 221	ALYAN ANAHTARLI KOLEKTÖR SETİ, 9'LU		1.968	3
	601 026 222	ALYAN ANAHTARLI KOLEKTÖR SETİ, 10'LU		2.163	3
	601 026 223	ALYAN ANAHTARLI KOLEKTÖR SETİ, 11'Lİ		2.379	2
	601 026 224	ALYAN ANAHTARLI KOLEKTÖR SETİ, 12'Lİ		2.595	2
	601 026 225	ALYAN ANAHTARLI KOLEKTÖR SETİ, 13'LÜ		2.790	2



Çıkış Sayısı	D ₁	D ₂	L
2	G 1"	G 3/4"	128,5
3			188,5
4			248,5
5			308,5
6			368,5
7			428,5
8			488,5
9			548,5
10			608,5
11			668,5
12			728,5
13			788,5

- Çalışma Basıncı: 6 bar
- Test Basıncı: 10 bar (20°C)
- Kullanma sıcaklığı: -10°C , +70°C
- Gidiş kolektöründe debi ayar klape grupları yoktur.
- Dönüş kolektörü aktuatör montajına uygun hat ayar vanalıdır.
- Kolektör tapaları dahildir.

AKILLI ODA TERMOSTATI

ÜRÜN	ÜRÜN KODU	ÜRÜN ADI	TEKNİK ÇİZİM	LİSTE FİYATI ₺	ÜRÜN KT. AD.
	601 021 037	AKILLI ODA TERMOSTATI		1.560	3

- Röle Çıkış Tipi: Kuru Kontak
- Anahtarlama Kapasitesi: 5A 250VAC / 3A 30VDC
- Beslenme Gerilimi: 100-240VAC
- Kutu içeriği: Vida Poşeti, Çift taraflı Bant

DİJİTAL ODA TERMOSTATI

ÜRÜN	ÜRÜN KODU	ÜRÜN ADI	TEKNİK ÇİZİM	LİSTE FİYATI ₺	ÜRÜN KT. AD.
	601 021 031	DİJİTAL ODA TERMOSTATI ANKASTRE-DUVAR İÇİ HAZNELİ		456	5

- 220/240 V, 50/60Hz

MEKANİK ODA TERMOSTATI

ÜRÜN	ÜRÜN KODU	ÜRÜN ADI	TEKNİK ÇİZİM	LİSTE FİYATI ₺	ÜRÜN KT. AD.
	601 021 030	MEKANİK ODA TERMOSTATI 10°C-30°C		150	5
	601 021 033	MEKANİK ODA TERMOSTATI MIN. 15-30°C		150	5

- 220/240 V, 50/60Hz

ANA KONTROL ÜNİTESİ



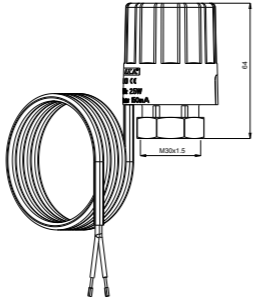

ÜRÜN	ÜRÜN KODU	ÜRÜN ADI	TEKNİK ÇİZİM	LİSTE FİYATI ₺	ÜRÜN KT. AD.
	601 021 010	ANA KONTROL ÜNİTESİ ELEKTRİK SİNYAL DAĞITICI (8 ÇIKIŞLI)		589	3

- CE
- Oda Termostatları, aktuatör, pompa ve karışım valflerinin entegrasyonu/kontrolü.
- Çalışma konum gösterge lambaları
- Elektrik ve Termal emniyetli
- Güç kaynağı: 100-240 VAC 50/60 Hz
- Max. Toplam Akım: 10 A
- Çalışma Sıcaklığı: -20 °C -60°C
- Depolama Sıcaklığı: -20 °C -70 °C

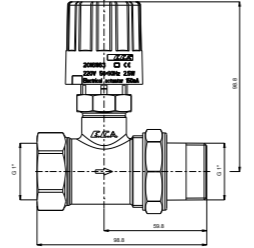

TERMAL KONTROL VANA MOTORU (AKTÜATÖR)

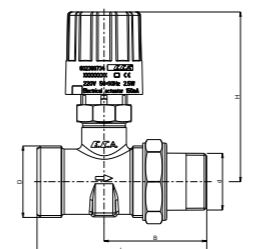
ÜRÜN	ÜRÜN KODU	ÜRÜN ADI	TEKNİK ÇİZİM	LİSTE FİYATI ₺	ÜRÜN KT. AD.
	602 120 742	M30X1.5 AKTÜATÖR TERMAL KONTROL VANA MOTORU 230V <ul style="list-style-type: none"> • CE • Normalde Kapalı(NC). İstenildiğinde Normalde Açık(NO) değişimi yapılabilir. • Açık ve Kapalı Konum göstergeli. • Gerilim 230V • Çevrim süresi:4.5 dakika • Hareket Mesafesi 3 mm • İtme kuvveti 90-125N • Güç 2.5W • Akım 150mA 		182	10

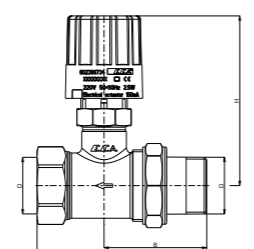

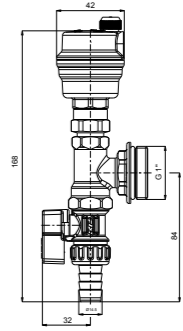

2-YOLLU TERMAL KONTROL MOTORLU (AKTÜATÖRLÜ) VANA

ÜRÜN	ÜRÜN KODU	ÜRÜN ADI	TEKNİK ÇİZİM	LİSTE FİYATI ₺	ÜRÜN KT. AD.
	602 120 747	2-YOLLU 1" AKTÜATÖRLÜ VANA - ÇIKIŞ RAKORLU <ul style="list-style-type: none"> • E.C.A. Aktuatör ve E.C.A. Oda Termostati ile uyumlu çalışır. • Vana PN16 		373	2
	602 120 804	2-YOLLU 1" AKTÜATÖRLÜ VANA DIŞ VİDA x RAKOR BAĞLANTILI <ul style="list-style-type: none"> • E.C.A. Aktuatör ve E.C.A. Oda Termostati ile uyumlu çalışır. • Vana PN16 		373	2
	602 120 863	2-YOLLU 1" AKTÜATÖRLÜ VANA-GİRİŞ RAKORLU <ul style="list-style-type: none"> • E.C.A. Aktuatör ve E.C.A. Oda Termostati ile uyumlu çalışır. • Vana PN16 		373	2

HAVA/SU BOŞALTMA SETİ

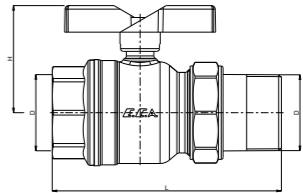
ÜRÜN	ÜRÜN KODU	ÜRÜN ADI	TEKNİK ÇİZİM	LİSTE FİYATI ₺	ÜRÜN KT. AD.
	602 399 746	HAVA/SU BOŞALTMA SETİ KIRMIZI VOLAN		179	10
	602 399 747	HAVA/SU BOŞALTMA SETİ MAVİ VOLAN <ul style="list-style-type: none"> • Otomatik Havalandırıcı, Mini Küresel Valf, Tee, Redüksiyon Tapa • Max. Çalışma Sıcaklığı: +80°C • Max. Çalışma Basınç: 10 bar 		179	10

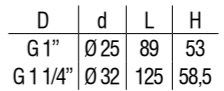
RAKORLU KÜRESEL VALF



ÜRÜN	ÜRÜN KODU	ÜRÜN ADI	TEKNİK ÇİZİM	LİSTE FİYATI ₺	ÜRÜN KT. AD.
	102 122 205	1" RAKORLU KÜRESEL VALF KIRMIZI KELEBEK VOLANLI		138	15
	102 122 347	1" RAKORLU KÜRESEL VALF MAVİ KELEBEK VOLANLI <ul style="list-style-type: none"> • PN 10 • Max. Çalışma Sıcaklığı: +80°C • Max. Çalışma Basınç: 10 bar 		138	15
	602 122 180	1 1/4" RAKORLU KÜRESEL VALF KIRMIZI KELEBEK VOLANLI		322	15
	602 122 181	1 1/4" RAKORLU KÜRESEL VALF MAVİ KELEBEK VOLANLI <ul style="list-style-type: none"> • PN 10 • Max. Çalışma Sıcaklığı: +80°C • Max. Çalışma Basınç: 10 bar 		322	15

D	d	L	H
G 1"	Ø25	89	53
G 1 1/4"	Ø32	125	58,5

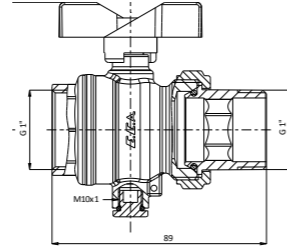
TERMOKUPL ÇIKIŞLI RAKORLU KÜRESEL VALF

ÜRÜN	ÜRÜN KODU	ÜRÜN ADI	TEKNİK ÇİZİM	LİSTE FİYATI ₺	ÜRÜN KT. AD.
	602 122 157	1" TERMOKUPL ÇIKIŞLI RAKORLU KÜRESEL VALF • PN 10 • Max. Çalışma Sıcaklığı: +80°C • Max. Çalışma Basıncı: 10 bar		144	15

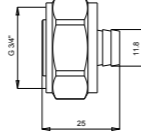

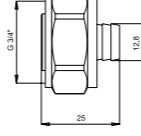
PEX BAĞLANTI RAKOR GRUBU (DÖŞEMEDEN ISITMA)

ÜRÜN	ÜRÜN KODU	ÜRÜN ADI	TEKNİK ÇİZİM	LİSTE FİYATI ₺	ÜRÜN KT. AD.
	602 199 343	3/4" X Ø16X2 MM PEX BAĞLANTI RAKOR GRUBU		29	80
	602 399 929	3/4" X Ø17X2 MM PEX BAĞLANTI RAKOR GRUBU		29	80

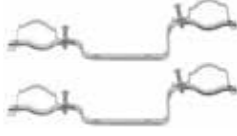
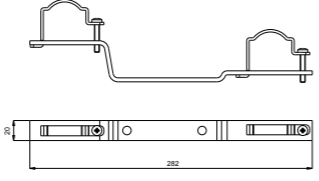
KOLLEKTÖR ASKI SETİ (DÖŞEMEDEN ISITMA)

ÜRÜN	ÜRÜN KODU	ÜRÜN ADI	TEKNİK ÇİZİM	LİSTE FİYATI ₺	ÜRÜN KT. AD.
	610 212 003	1" DEBİMETRELİ VE AKTÜATÖR BAĞLANTILI KOLEKTÖRLER İÇİN ASKI SETİ • Duvar sabitleme vidaları hariçtir.		60	10

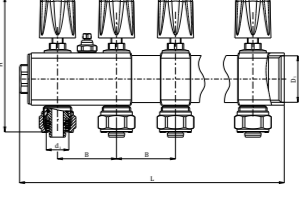
DÖŞEMEDEN DAĞITIM SİSTEMLERİ E.C.A. 02 1" - Ø16 x 2 mm debi ayar vanalı kolektörler

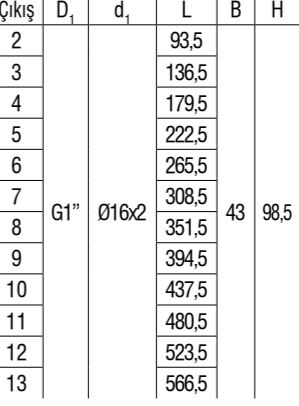
ÜRÜN	ÜRÜN KODU	ÜRÜN ADI	TEKNİK ÇİZİM	LİSTE FİYATI ₺	ÜRÜN KT. AD.
	602 120 695*	1" DEBİ AYAR VANALI KOLEKTÖR 2'Lİ - KIRMIZI VOLANLI		125	5
	602 120 680*	1" DEBİ AYAR VANALI KOLEKTÖR 3'LÜ - KIRMIZI VOLANLI		174	5
	602 120 681*	1" DEBİ AYAR VANALI KOLEKTÖR 4'LÜ - KIRMIZI VOLANLI		224	9
	602 120 682*	1" DEBİ AYAR VANALI KOLEKTÖR 5'Lİ - KIRMIZI VOLANLI		260	12
	602 120 683*	1" DEBİ AYAR VANALI KOLEKTÖR 6'Lİ - KIRMIZI VOLANLI		311	6
	602 120 684*	1" DEBİ AYAR VANALI KOLEKTÖR 7'Lİ - KIRMIZI VOLANLI		360	6
	602 120 685*	1" DEBİ AYAR VANALI KOLEKTÖR 8'Lİ - KIRMIZI VOLANLI		411	8
	602 120 686*	1" DEBİ AYAR VANALI KOLEKTÖR 9'LU - KIRMIZI VOLANLI		464	8
	602 120 687*	1" DEBİ AYAR VANALI KOLEKTÖR 10'LU - KIRMIZI VOLANLI		515	4
	602 120 688*	1" DEBİ AYAR VANALI KOLEKTÖR 11'Lİ - KIRMIZI VOLANLI		564	4
	602 120 689*	1" DEBİ AYAR VANALI KOLEKTÖR 12'Lİ - KIRMIZI VOLANLI		619	4
	602 120 690*	1" DEBİ AYAR VANALI KOLEKTÖR 13'LÜ - KIRMIZI VOLANLI		668	4
		602 120 694*		1" DEBİ AYAR VANALI KOLEKTÖR 2'Lİ - MAVİ VOLANLI	
602 120 669*		1" DEBİ AYAR VANALI KOLEKTÖR 3'LÜ - MAVİ VOLANLI	174	5	
602 120 670*		1" DEBİ AYAR VANALI KOLEKTÖR 4'LÜ - MAVİ VOLANLI	224	9	
602 120 671*		1" DEBİ AYAR VANALI KOLEKTÖR 5'Lİ - MAVİ VOLANLI	260	12	
602 120 672*		1" DEBİ AYAR VANALI KOLEKTÖR 6'Lİ - MAVİ VOLANLI	311	6	
602 120 673*		1" DEBİ AYAR VANALI KOLEKTÖR 7'Lİ - MAVİ VOLANLI	360	6	
602 120 674*		1" DEBİ AYAR VANALI KOLEKTÖR 8'Lİ - MAVİ VOLANLI	411	8	
602 120 675*		1" DEBİ AYAR VANALI KOLEKTÖR 9'LU - MAVİ VOLANLI	464	8	
602 120 676*		1" DEBİ AYAR VANALI KOLEKTÖR 10'LU - MAVİ VOLANLI	515	4	
602 120 677*		1" DEBİ AYAR VANALI KOLEKTÖR 11'Lİ - MAVİ VOLANLI	564	4	
602 120 678*		1" DEBİ AYAR VANALI KOLEKTÖR 12'Lİ - MAVİ VOLANLI	619	4	
602 120 679*		1" DEBİ AYAR VANALI KOLEKTÖR 13'LÜ - MAVİ VOLANLI	668	4	



* 17x2 mm plastik boru, 15x2 mm boru seçenekleri siparişe özel üretilecek olup ayrıca fiyatlandırılacaktır.

- TSEK belgeli
- Sıcak Sulu Isıtma sistemleri, 10 bar, 120°C
- Kolektörler üzerinde purjör bulunmaktadır.
- Körtapa dahildir.
- Nikel Kaplamalı

Çıkış	D ₁	d ₁	L	B	H
2	G1"	Ø16x2	93,5	43	98,5
3			136,5		
4			179,5		
5			222,5		
6			265,5		
7			308,5		
8			351,5		
9			394,5		
10			437,5		
11			480,5		
12			523,5		
13			566,5		

DÖŞEMEDEN DAĞITIM SİSTEMLERİ

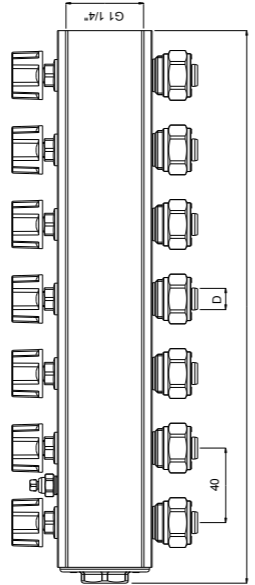
E.C.A. 01 1 1/4" debi ayar vanalı kolektörler

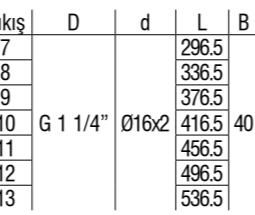
ÜRÜN	ÜRÜN KODU	ÜRÜN ADI	TEKNİK ÇİZİM	LİSTE FİYATI ₺	ÜRÜN KT. AD.																																																	
	602 120 608*	1 1/4" DEBİ AYAR VANALI KOLEKTÖR, 7'Lİ - KIRMIZI VOLANLI		620	4																																																	
	602 120 609*	1 1/4" DEBİ AYAR VANALI KOLEKTÖR, 8'Lİ - KIRMIZI VOLANLI		706	6																																																	
	602 120 610*	1 1/4" DEBİ AYAR VANALI KOLEKTÖR, 9'LU - KIRMIZI VOLANLI		794	6																																																	
	602 120 611*	1 1/4" DEBİ AYAR VANALI KOLEKTÖR, 10'LU - KIRMIZI VOLANLI		883	2																																																	
	602 120 612*	1 1/4" DEBİ AYAR VANALI KOLEKTÖR, 11'Lİ - KIRMIZI VOLANLI		971	2																																																	
	602 120 613*	1 1/4" DEBİ AYAR VANALI KOLEKTÖR, 12'Lİ - KIRMIZI VOLANLI		1.061	2																																																	
	602 120 614*	1 1/4" DEBİ AYAR VANALI KOLEKTÖR, 13'LÜ - KIRMIZI VOLANLI		1.144	2																																																	
	602 120 601*	1 1/4" DEBİ AYAR VANALI KOLEKTÖR, 7'Lİ - MAVİ VOLANLI			620	4																																																
	602 120 602*	1 1/4" DEBİ AYAR VANALI KOLEKTÖR, 8'Lİ - MAVİ VOLANLI			706	6																																																
	602 120 603*	1 1/4" DEBİ AYAR VANALI KOLEKTÖR, 9'LU - MAVİ VOLANLI			794	6																																																
	602 120 604*	1 1/4" DEBİ AYAR VANALI KOLEKTÖR, 10'LU - MAVİ VOLANLI			883	2																																																
	602 120 605*	1 1/4" DEBİ AYAR VANALI KOLEKTÖR, 11'Lİ - MAVİ VOLANLI			971	2																																																
	602 120 606*	1 1/4" DEBİ AYAR VANALI KOLEKTÖR, 12'Lİ - MAVİ VOLANLI			1.061	2																																																
	602 120 607*	1 1/4" DEBİ AYAR VANALI KOLEKTÖR, 13'LÜ - MAVİ VOLANLI	1.144		2																																																	
		<table border="1"> <thead> <tr> <th>Çıkış</th> <th>D</th> <th>d</th> <th>L</th> <th>B</th> <th>H</th> </tr> </thead> <tbody> <tr> <td>7</td> <td></td> <td></td> <td>296.5</td> <td></td> <td></td> </tr> <tr> <td>8</td> <td></td> <td></td> <td>336.5</td> <td></td> <td></td> </tr> <tr> <td>9</td> <td></td> <td></td> <td>376.5</td> <td></td> <td></td> </tr> <tr> <td>10</td> <td>G 1 1/4"</td> <td>Ø16x2</td> <td>416.5</td> <td>40</td> <td>95</td> </tr> <tr> <td>11</td> <td></td> <td></td> <td>456.5</td> <td></td> <td></td> </tr> <tr> <td>12</td> <td></td> <td></td> <td>496.5</td> <td></td> <td></td> </tr> <tr> <td>13</td> <td></td> <td></td> <td>536.5</td> <td></td> <td></td> </tr> </tbody> </table>			Çıkış	D	d	L	B	H	7			296.5			8			336.5			9			376.5			10	G 1 1/4"	Ø16x2	416.5	40	95	11			456.5			12			496.5			13			536.5				
Çıkış	D	d	L		B	H																																																
7			296.5																																																			
8			336.5																																																			
9			376.5																																																			
10	G 1 1/4"	Ø16x2	416.5		40	95																																																
11			456.5																																																			
12			496.5																																																			
13			536.5																																																			

* 17x2 mm plastik boru, 15x2 mm boru seçenekleri siparişe özel üretilecek olup ayrıca fiyatlandırılacaktır.

- TSEK belgesi
- Sıcak Sulu Isıtma sistemleri, sıhhi tesisatlar 10bar, 120°C
- Kolektörler üzerinde purjör bulunmaktadır.
- Körtapa dahildir.
- Nikel Kaplamalı

KOLEKTÖR BAĞLANTI ELEMANLARI

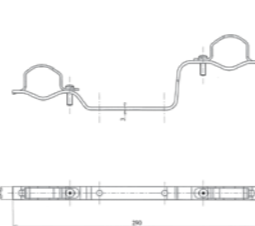
ÜRÜN	ÜRÜN KODU	ÜRÜN ADI	TEKNİK ÇİZİM	LİSTE FİYATI ₺	ÜRÜN KT. AD.
	610 212 001	KELEPÇELİ 1" KOLEKTÖR KONSOLU İKİLİ SET (E.C.A. 02 TİPİ İÇİN)		33	10
		• Duvar sabitleme vidaları hariçtir.			

GENEL DAĞITIM

ELMOR TESİSAT MALZEMESİ TİCARET A.Ş.

Merkez

Kemeraltı Cad. Ümmehan No:17/2 Karaköy/İSTANBUL
Tel: (0212) 705 51 00 Faks: (0212) 249 90 91
www.eca.com.tr elmor@elmor.com.tr

İstanbul Bölge Satış Müdürlüğü

Kemeraltı Cad. Ümmehan No:17/2 Karaköy/İSTANBUL
Tel: (0212) 705 51 00 Faks: (0212) 249 90 91

Ankara Bölge Satış Müdürlüğü

Turan Güneş Bulvarı No:67 Yıldız - Çankaya/ANKARA
Tel: (0850) 258 30 20 Faks: (0312) 490 04 45

İzmir Bölge Satış Müdürlüğü

Gaziler Cad. Yenişehir İş Merkezi No: 478/106 Yenişehir/İZMİR
Tel: (0850) 258 30 40 Faks: (0232) 469 82 30

Adana Bölge Satış Müdürlüğü

2000 Evler Mh. 76066 Sk. Fonte İş Merkezi - A Blok No: 2 İç Kapı No:6 ADANA
Tel: (0850) 258 30 00 Faks: (0322) 234 00 76

Antalya Bölge Satış Müdürlüğü

Gebizli Mh: Termassos Bulvarı By Plaza A Blok Kat:4 No:50/8 Muratpaşa/ANTALYA
Tel: (0850) 258 30 60 Faks: (0242) 312 63 20

Bursa Bölge Satış Müdürlüğü

23 Nisan Mh. Yunus Emre Cad. 255. Sk. Tuğtaş Ofis No: 1 Kat: 4 D: 14 Nilüfer/BURSA
Tel: (0850) 258 30 50 Faks: (0224) 453 13 70

Trabzon Bölge Satış Müdürlüğü

2 Nolu Beşirli Mh. Devlet Sahil Yolu Cad. 186/7 Ortahisar/TRABZON
Tel: (0850) 258 30 70 Faks: (0462) 223 61 22

Samsun Bölge Ofis

Borkonut Center İş Merkezi Kiliçdere Mh. Kastamonu Sk. No:8 / B Kat: 5 / 66 İlkadım/SAMSUN
Tel: (0362) 435 74 30 Faks: (0362) 435 74 34

Diyarbakır Bölge Temsilciliği

Mezopotamya Mh. 332 Sk. Kutay Plaza Trend Office No: 6 Kat: 8/30 Kayapınar/DİYARBAKIR
Tel: (0412) 257 40 33 Faks: (0412) 257 40 34

Kayseri Bölge Temsilciliği

Gevher Nesibe Mh. İstasyon Cad. Soylu İş Merkezi No: 41/8 Kocasinan/KAYSERİ
Tel: (0352) 232 35 37 Faks: (0352) 232 35 87

TEŞHİR ve GALERİLER

İstanbul Elmor Plus

Erenköy Mh. Şemsettin Günaltay Cad. No:207/17-18 Güler Apt. Kadıköy
Tel: (0216) 445 67 93

İzmir Anıt Mağaza

Şehit Nevres Bulvarı No:1 Alsancak Konak/İZMİR
Tel: (0850) 258 30 40 Faks: (0232) 469 82 30

Adana Elmor Plus

Gürselpaşa Mh. Aliya İzzet Begoviç Bulv. B Blok No: 6/A Seyhan/ADANA
Tel: (0322) 249 00 88 Faks: (0322) 249 00 66

SATIŞ SONRASI SERVİS



EMAR SATIŞ SONRASI MÜŞTERİ HİZMETLERİ SANAYİ ve TİCARET A.Ş.

Emar Servis Müdürlüğü

İstanbul Bölge Servis Şefliği

Esentepe Mh. Kasap Sk. No:15/1 34394 Şişli/İSTANBUL
Tel: (0212) 370 13 22 Faks: (0212) 370 13 23

Ankara Bölge Servis Şefliği

Turan Güneş Blv. No:67/2 Yıldız -Çankaya / ANKARA
Tel: (0212) 370 13 22 Faks: (0212) 370 13 23

İzmir Bölge Servis Şefliği

1348 Sk. Keremoglu İş Merkezi No:2/E Yenişehir / İZMİR
Tel: (0212) 370 13 22 Faks: (0212) 370 13 23

Antalya Bölge Servis Şefliği

Gebizli Mh. Termassos Bulvarı 50A/8(302) BY Plaza A Blok Muratpaşa / ANTALYA
Tel: (0212) 370 13 22 Faks: (0212) 370 13 23

www.emarservis.com.tr

emar@emarservis.com.tr



www.eca.com.tr

GENEL DAĞITIM

Elmor Tesisat Malzemesi Ticaret A.Ş.

Tel: (0212) 705 51 00

elmor@elmor.com.tr

YETKİLİ SERVİS

Emar Satış Sonrası Müşteri Hizmetleri San. Tic. A.Ş.

Tel: (0212) 370 13 22

emar@emarservis.com.tr

